

All files are PDF; you need Acrobat Reader to view them.

[\(Download Acrobat Reader\)](#) 

Proceedings of the Conference on Coastal Watersheds: The Caspar Creek Story



Robert R. Ziemer, *Technical Coordinator*

Contents

[Preface](#) 385 K

[Overview of the Caspar Creek Watershed Study](#) 143 K

Norm Henry

[Why Caspar Creek-Then and Now](#) 143 K

Raymond M. Rice

[Flooding and Stormflows](#) 330 K

Robert R. Ziemer

[Subsurface Drainage Processes and Management Impacts](#) 550 K

Elizabeth T. Keppeler and David Brown

[The Summer Flow and Water Yield Response to Timber Harvest](#) 187 K

Elizabeth T. Keppeler

[Effects of Forest Harvest on Stream-Water Quality and Nitrogen Cycling in the Caspar Creek Watershed](#) 187 K

Randy A. Dahlgren

[Evaluating the Impacts of Logging Activities on Erosion and Suspended Sediment Transport in the Caspar Creek Watersheds](#) 297 K

Jack Lewis

[Buffering the Buffer](#) 176 K

Leslie M. Reid and Sue Hilton

[Effects of Recent Logging on the Main Channel of North Fork Caspar Creek](#) 165 K

Thomas E. Lisle and Michael B. Napolitano

[Effects of Timber Harvest on Aquatic Vertebrates and Habitat in the North Fork Caspar Creek](#) 165 K

Rodney J. Nakamoto

[Persistence of Historical Logging Impacts on Channel Form in Mainstem North Fork Caspar Creek](#) 88 K

Michael B. Napolitano

[Logging Impacts of the 1970's vs. the 1990's in the Caspar Creek Watershed](#) 198 K

Peter H. Cafferata and Thomas E. Spittler

[Cumulative Watershed Effects: Caspar Creek and Beyond](#) 132 K

Leslie M. Reid

[Monitoring Watersheds and Streams](#) 121 K

Robert R. Ziemer

[Where Do We Go from Here?](#) 44 K

Raymond M. Rice

[Publications Related to Caspar Creek](#) 132 K

Ingrid Morken and Robert R. Ziemer

[Cover, and Publication Information](#) 264 K

[Back to Publications Page](#)



United States
Department
of Agriculture

Forest Service

Pacific Southwest
Research Station

General Technical Report
PSW-GTR-168



Proceedings of the Conference on Coastal Watersheds: The Caspar Creek Story

May 6, 1998 Ukiah, California

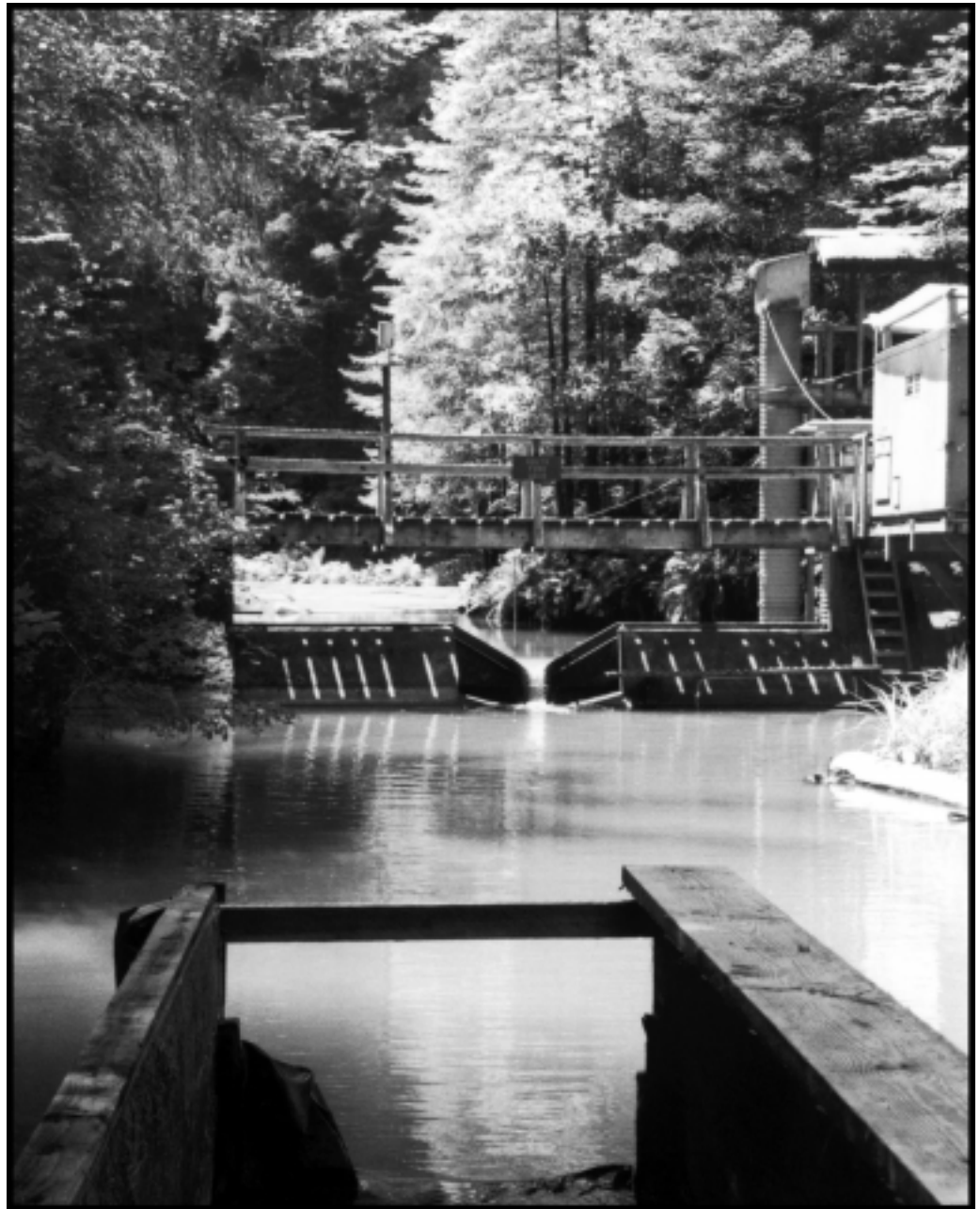

Publisher:

Albany, California
Mailing address:
PO Box 245, Berkeley CA
94701-0245

(510) 559-6300

[http://www.psw.fs.fed.us/
techpub.html](http://www.psw.fs.fed.us/techpub.html)

June 1998

Pacific Southwest Research Station

Forest Service
U.S. Department of Agriculture

Abstract

Ziemer, Robert R., technical coordinator. 1998. **Proceedings of the conference on coastal watersheds: the Caspar Creek Story; 6 May 1998; Ukiah, CA.** Gen. Tech. Rep. PSW-GTR-168. Albany, CA: Pacific Southwest Research Station, Forest Service, U.S. Department of Agriculture; 149 p.

These proceedings report on 36 years of research at the Caspar Creek Experimental Watershed, Jackson Demonstration State Forest in northwestern California. The 16 papers include discussions of streamflow, sediment production and routing, stream channel condition, soil moisture and subsurface water, nutrient cycling, aquatic and riparian habitat, streamside buffers, cumulative effects, monitoring. A detailed annotated bibliography of 107 papers from Caspar Creek is included.

Retrieval Terms: cumulative effects, nutrient, paired-watersheds, riparian, sediment, soil moisture, streamflow

Technical Coordinator

Robert R. Ziemer is Project Leader and Chief Research Hydrologist at the Station's Redwood Sciences Laboratory, 1700 Bayview Drive, Arcata, CA 95521.

Acknowledgments

Since 1961, research at the Caspar Creek Experimental Watersheds, located on the Jackson Demonstration State Forest, has been a cooperative venture between the California Department of Forestry and Fire Protection and the USDA Forest Service's Pacific Southwest Research Station (Agreement 12-11-0215-19).

Front cover: A view of the South Fork Caspar Creek gaging station (SFC), looking upstream from the fish ladder toward the weir. Photo by Norm Henry, California Department of Forestry and Fire Protection.

Back cover: A view of the tributary Dollard gaging station (DOL) in the North Fork of Caspar Creek, looking upstream at the Parshall flume. Photo by Norm Henry, California Department of Forestry and Fire Protection.

Proceedings of the Conference on Coastal Watersheds: The Caspar Creek Story

May 6, 1998 Ukiah, California

Robert R. Ziemer, *Technical Coordinator*

Contents

Preface	iii
Overview of the Caspar Creek Watershed Study	1
<i>Norm Henry</i>	
Why Caspar Creek—Then and Now	11
<i>Raymond M. Rice</i>	
Flooding and Stormflows.....	15
<i>Robert R. Ziemer</i>	
Subsurface Drainage Processes and Management Impacts	25
<i>Elizabeth T. Keppeler and David Brown</i>	
The Summer Flow and Water Yield Response to Timber Harvest.....	35
<i>Elizabeth T. Keppeler</i>	
Effects of Forest Harvest on Stream-Water Quality and Nitrogen Cycling in the Caspar Creek Watershed.....	45
<i>Randy A. Dahlgren</i>	
Evaluating the Impacts of Logging Activities on Erosion and Suspended Sediment Transport in the Caspar Creek Watersheds	55
<i>Jack Lewis</i>	
Buffering the Buffer	71
<i>Leslie M. Reid and Sue Hilton</i>	
Effects of Recent Logging on the Main Channel of North Fork Caspar Creek.....	81
<i>Thomas E. Lisle and Michael B. Napolitano</i>	
Effects of Timber Harvest on Aquatic Vertebrates and Habitat in the North Fork Caspar Creek	87
<i>Rodney J. Nakamoto</i>	
Persistence of Historical Logging Impacts on Channel Form in Mainstem North Fork Caspar Creek.....	97
<i>Michael B. Napolitano</i>	
Logging Impacts of the 1970's vs. the 1990's in the Caspar Creek Watershed	103
<i>Peter H. Cafferata and Thomas E. Spittler</i>	
Cumulative Watershed Effects: Caspar Creek and Beyond	117
<i>Leslie M. Reid</i>	
Monitoring Watersheds and Streams.....	129
<i>Robert R. Ziemer</i>	
Where Do We Go from Here?	135
<i>Raymond M. Rice</i>	
Publications Related to Caspar Creek	137
<i>Ingrid Morken and Robert R. Ziemer</i>	

USDA Forest Service

General Technical
Report
PSW-GTR-168

June 1998



Preface

A program for watershed research in California's coniferous forests below the snow zone was proposed in 1960 by Henry W. Anderson (Anderson 1960). On July 1, 1961, cooperative watershed management research in this lower conifer zone was started by the USDA Forest Service's Pacific Southwest Forest and Range Experiment Station (now Pacific Southwest Research Station [PSW]), with formal cooperation of the State of California's Division of Forestry (now Department of Forestry and Fire Protection [CDF]) and the Department of Water Resources. The Caspar Creek study, formally described as "Study 2-1, a study of logging effects upon streamflow, sedimentation, fish life and fish habitat in the north coast redwood-Douglas-fir forest type Jackson State Forest, Fort Bragg, California," was one of the first studies undertaken by PSW's new Lower Conifer Research Unit. By October 1, 1961, bedrock stream gaging sites had been located in two tributaries of Caspar Creek, maximum (peak) stage and staff gages and five standard raingages had been installed, and weekly suspended sediment samples and stage heights had been collected (Hopkins and Bowden 1962). The California Department of Water Resources, working with PSW, CDF, and State of California Department of Fish and

Game, designed the streamgaging weirs and fish ladders. Cement, reinforcing steel, and aggregate were purchased by PSW, and the weirs were built by CDF in summer 1962. The North and South Fork weirs began operation on October 1, 1962.

The first agreement between PSW and CDF "providing for cooperation in the conduct of a program of watershed management to determine the effect of forest management upon streamflow, sedimentation, fish, fish habitat, timber and other vegetative growth" became effective January 12, 1962. This agreement (12-11-0215-19) was amended with an annual work plan each year from 1962 to 1997. In 1998, a new agreement was approved.

The Caspar Creek Experimental Watersheds, as they were designated in 1962, consist of the 424-ha South Fork and 473-ha North Fork. These two tributary basins are located in the headwaters of the 2,167-ha Caspar Creek watershed, which discharges into the Pacific Ocean near the community of Caspar (*fig. 1*). Logging roads were built into the South Fork in 1967. The entire South Fork watershed was selectively harvested and tractor yarded; about one third in 1971, 1972, and 1973, respectively (Henry, these proceedings). In 1985, 13 additional streamgaging stations were

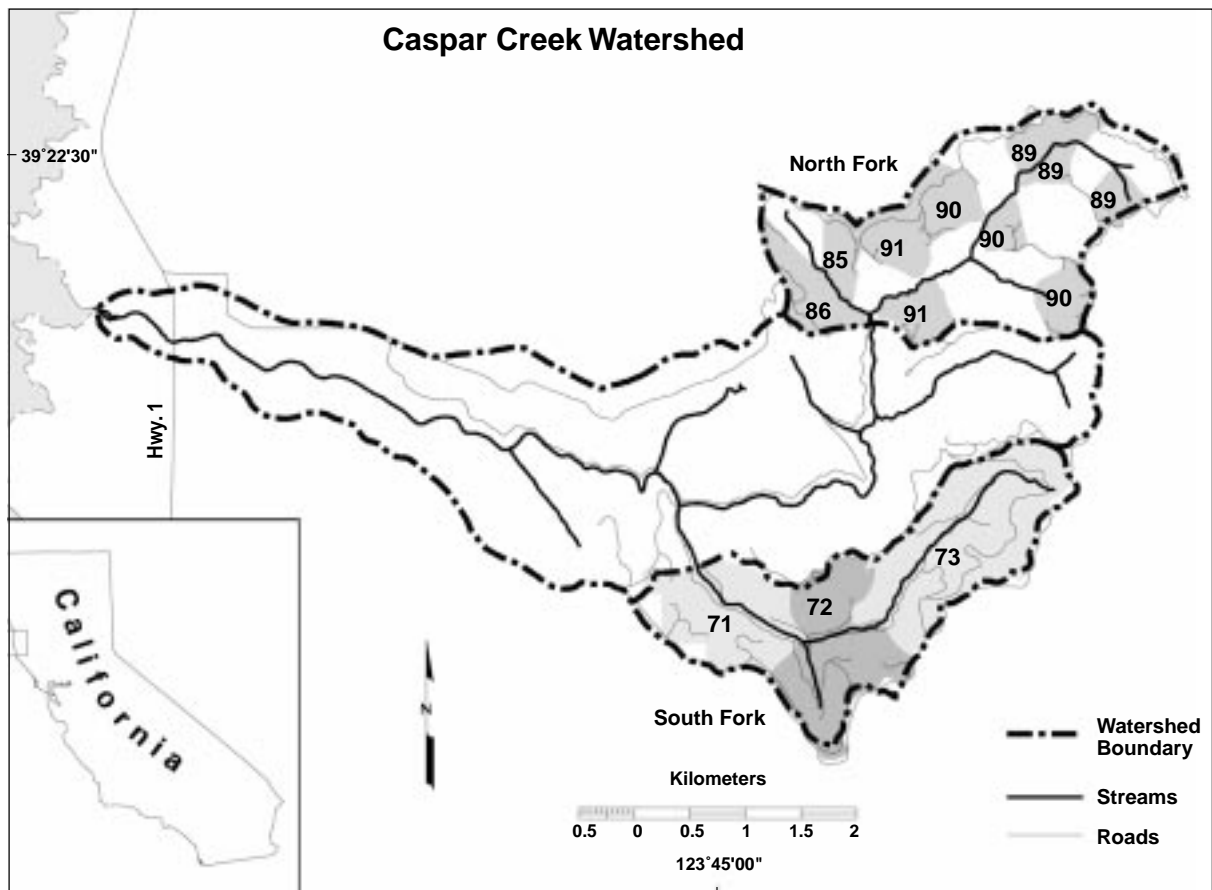

Figure 1 — The Caspar Creek Experimental Watershed is located in northern California.

constructed in the North Fork. The North Fork was clearcut logged in large patches in 1985, 1986, 1989, 1990, and 1991 (*figs. 1, 2*). The subwatersheds of the North Fork and the 14 gaging stations, raingages, subsurface and piping sites, solar radiometer, and splash dam (*fig. 2*) are described in the papers that follow.

Much of the data collected during this study's 37 years are available on CD-ROM from PSW's Redwood Sciences Laboratory, at Arcata, California (Ziemer 1998). This data set and its earlier release are a valuable resource to researchers, educators, and students around the world and are unique in detail and resolution.

These Proceedings are the written product of the **Conference on Coastal Watersheds: The Caspar Creek Story**, organized by Bill Baxter (California Department of Forestry and Fire Protection), Liz Keppeler (Pacific Southwest Research Station), and Greg Giusti (University of California Extension). The Conference was held May 6, 1998 at the Mendocino Community College in Ukiah, California and was attended by about 400 persons. The next day, 75 individuals participated in a field trip through the North Fork of Caspar Creek. Attendance at both the Conference and the field trip was limited by seating capacity, and a number of potential registrants were turned away because of lack of space. The number of attendees attests to the keen interest in the effects of forest practices on the hydrologic responses of forested watersheds.

These Proceedings summarize 36 years of watershed research at Caspar Creek and include an annotated bibliography of the 107 papers that report the details of studies conducted during this cooperative venture. Further information concerning the Caspar Creek study can be found at the Redwood Sciences Laboratory Internet site at <http://www.rsl.psw.fs.fed.us>

References

Anderson, H.W. 1960. **Proposed program for watershed management research in the lower conifer zone of California.** Tech. Paper 46. Berkeley, CA: Pacific Southwest Forest and Range Experiment Station, Forest Service, U.S. Department of Agriculture; 21 p.

Hopkins, Walt; Bowden, Kenneth L. 1962. **First progress report, 1961-1962, cooperative watershed management in the lower conifer zone of California.** Berkeley, CA: Pacific Southwest Forest and Range Experiment Station, Forest Service, U.S. Department of Agriculture; 10 p.

Ziemer, R. 1998. **Caspar Creek hydrologic and climatic data: 1963-1997.** CD-ROM, 545 MB. 1998 May. Arcata, CA: Pacific Southwest Research Station, Forest Service, U.S. Department of Agriculture, and Fort Bragg, CA: California Department of Forestry and Fire Protection.

Robert R. Ziemer
Technical Coordinator

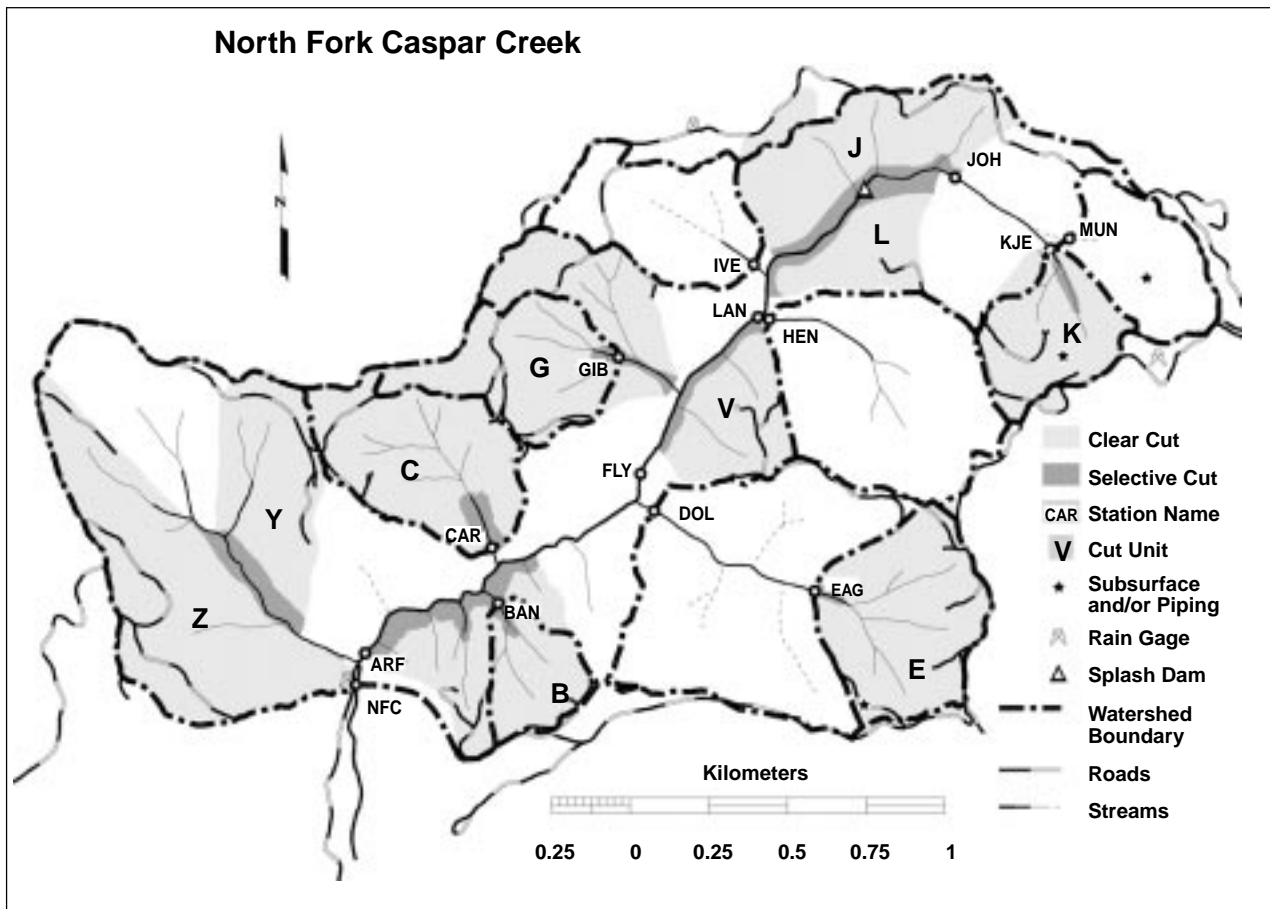

Figure 2 — North Fork Caspar Creek watershed.

Overview of the Caspar Creek Watershed Study¹

Norm Henry²

Abstract: *The California Department of Forestry and Fire Protection (CDF) and the Pacific Southwest Research Station, Redwood Sciences Laboratory (PSW) have been conducting watershed research within the Caspar Creek watershed on the Jackson Demonstration State Forest, in northern California, since 1962. A concrete broad-crested weir with a 120° low-flow V-notch was constructed in both the 473-ha North Fork and 424-ha South Fork of Caspar Creek by the late fall of 1962. Both watersheds supported predominantly second-growth stands of coast redwood (*Sequoia sempervirens* (D. Don) Endl.) and Douglas-fir (*Pseudotsuga menziesii* (Mirb.) Franco) averaging 700 m³ ha⁻¹ of stem wood. The study has been conducted in two phases. The South Fork phase was designed as a traditional paired-watershed study and involved monitoring the impacts of road construction and selection harvesting by tractor on streamflow, suspended sediment, and bedload. Approximately one-third of the watershed was logged in each year from 1971 to 1973, starting with the most downstream area. Several publications have documented the results from (1) the calibration and roading activities (1962-1971) and (2) the logging activity and subsequent monitoring through 1976. Planning for the North Fork phase started in the early 1980's. This study phase was initiated in response to new federal legislation requiring the evaluation of cumulative watershed effects as a part of management activities. The principal objective was to test for cumulative watershed effects (CWE) resulting from timber harvesting and related activities.*

The North Fork became the treatment watershed and was divided into 13 sub-basins including three control watersheds to be left untreated. Ten Parshall flumes and three rated sections were installed in the watershed — one at the outflow of each of these sub-basins. A new sampling system called SALT was developed along with the necessary sampling software and hardware for implementation.

Total timber volume removal in North Fork was slightly less than in the South Fork (about 50 percent); however, harvesting activities were limited to eight discrete clearcut harvest blocks ranging from 9 to 60 ha, occupying 35-100 percent of individual subwatersheds in the CWE study area. These harvest units were logged using primarily skyline cable yarding techniques. Road and landing construction and tractor logging were limited to ridgetop and upper slope locations. Auxiliary studies examining summer low flow, soil pipe flow, bedload movement, geochemical response, and biological aquatic effects were also monitored during this period. Monitoring began in 1985 and harvesting was done over a 3-year period (1989-1992). Harvesting began in the upper third of the North Fork watershed to aid in detecting the existence of possible CWE's. Monitoring was maintained at all gaging stations through hydrologic year 1995. After 1995, a long-term monitoring plan was instituted. This plan uses a subset of the gaging stations (SF, NF, A, C, D, E, H, I) to monitor the possible long-term effects of timber harvesting on stream discharge, suspended sediment, and bedload.

This overview of the history, site characteristics, major events, equipment, and sampling systems used during the life of the Caspar Watershed Study will provide background for the following papers in these proceedings.

Historical Land Use in the Study Area

Considerable disturbance of the inner gorge and channel areas occurred in the Caspar drainage before management by the State of California and the implementation of this study. The 2,167-ha Caspar watershed, like most north coast watersheds, was subject to intensive land-use practices spanning decades during the early old-growth logging era.

The first European settlement in the area was before the 1860's. The watershed and neighboring village were named after a local trapper, Siegfried Caspar. In 1860, the Caspar Logging Company was founded, the owners having purchased most of the Caspar Creek watershed. A sawmill was built at the mouth of Caspar Creek, ultimately producing up to 25,000 board feet of lumber per day. Jacob Green Jackson, after whom Jackson State Forest is named, bought the mill in 1864 and soon after had three log crib dams built on Caspar Creek. They were constructed of log cribbing with a rock and soil core with a flume and spillway through the center. A triggering mechanism enabled the operator to open the spillway gate when the natural stream flow was judged high enough. The dams were built to provide additional stream discharge for river log drives, permitting logging operations to be expanded into the upper reaches of Caspar Creek. Thirty thousand logs or more were often tiered in the channel, waiting to be floated down to the mill during high winter flows. Log drives required a full reservoir and a storm capable of raising the water level of the stream by about 2 feet. Francis Jackson, a local historian who found remnants of many crib dam sites on the local streams, estimated from historical archives that an average of two log drives per winter took place in each of the North and South Fork drainages (Napolitano 1996).

Clearcut logging was used exclusively during this era. The felled areas were broadcast burned to remove obstructions before yarding the old-growth logs by oxen teams over skid trails to "roll away" landing type areas near the stream channels. Logs were then jack screwed into the creek to form log tiers that would be floated downstream during the winter high flows. These activities involved extensive excavation into inner-gorge slope areas. Years later, railroads were expanded into upper reaches of some watersheds, and semi-mechanized yarding of remote canyon tributaries was made possible using railway inclines (also called tramways) powered by steam donkeys. For example, one incline was built to yard logs from the Dollard-Eagle subwatershed over the ridge to the railway in Hare Creek. Most of the watershed had been logged by

¹ An abbreviated version of this paper was presented at the Conference on Coastal Watersheds: The Caspar Creek Story, May 6, 1998, Ukiah, California.

² Forester II, Research and Demonstration Program, Jackson Demonstration State Forest, Mendocino Ranger Unit, California Department of Forestry and Fire Protection, 802 N. Main St., Fort Bragg, CA 95437. (norm_henry@fire.ca.gov).

the late 1890's, and by 1906, a quiescent period followed as Caspar Lumber Company moved eastward in search of new timbered areas to harvest. Harvest activities did not begin again until the early 1960's, after the State took over management of the area.

Caspar Watershed Study Genesis

As the State started harvesting many of the second-growth stands in the historically logged areas, more information was needed on the effects of logging and road-building on sedimentation and aquatic habitat. The impetus for beginning a joint study with federal and state agency cooperators in 1960 was to answer such questions as: (1) What are the water and sediment production of north coast watersheds that have been undisturbed for many years?, (2) How are water yield, water quality, flood peaks, and stream sedimentation affected by current road-building and logging practices?, and (3) What changes take place in the channel after logging, and how do these changes affect fish and their habitat? (Anonymous 1963). Early participants besides the California Department of Forestry and Fire Protection (CDF), Jackson Demonstration State Forest, and the Pacific Southwest Forest and Range Experiment Station (PSW), Redwood Sciences Laboratory, included Humboldt State University, California Department of Fish and Game, and the University of California. Staff from the California Department of Water Resources, and U.S. Geological Survey also participated in an advisory capacity at the initial design stage of the study.

Methods

Location

The study is located in the Caspar Creek Experimental Watershed on the Jackson Demonstration State Forest (Preface, fig. 1, these proceedings). The watershed study encompasses 897 ha of the North and South Forks of Caspar Creek in northwestern California. The basins are located about 7 km from the Pacific Ocean at approximately 39°21'N, 123°44'W and have a general west-southwest orientation. The North and South Fork weirs are approximately 14 and 15 km, respectively, southeast of Fort Bragg, California.

Topography and Soils

Topographic development consists of uplifted marine terraces that are deeply incised by coastal streams. About 35 percent of the basin's slopes are less than 17° and 7 percent are steeper than 35°. The hillslopes are steepest near the stream channel with inner-gorge slope gradients of 50 percent or more. A slope change typically occurs 100 m to 350 m upslope, becoming more gentle near the broad and rounded ridgetops. The elevation of the watershed ranges from 37 to 320 m.

The soils in the Caspar Creek study basins are well-drained clay-loams 1 to 2 m in depth, and are derived from Franciscan sandstone and weathered coarse-grained shale of the Cretaceous Age. They have high hydraulic conductivity, and subsurface stormflow is rapid, producing saturated areas of only limited extent and duration (Wosika 1981). Three soil complexes are dominant in the study area. The Vandamme, Irmulco-Tramway, and Dehaven-

Hotel series occupy the upper, mid, and inner-gorge areas, respectively. The first two complexes account for approximately 90 percent of the area.

Climate

A Mediterranean climate is typical of low-elevation watersheds on the central North American Pacific coast. The fall and winter seasons are characterized by a westerly flow of moist air that typically results in low-intensity rainfall and prolonged cloudy periods with snow occurring rarely. In the spring, this weather pattern migrates northward, and rainfall becomes much less frequent. Summers are relatively dry, with cool coastal fog that typically can extend 16 km or more inland during the summer, often burning off to the coast by midday.

Temperatures are mild with muted annual extremes and narrow diurnal fluctuations due to the moderating effect of the Pacific Ocean. Average monthly air temperatures between 1990 and 1995 in December were 6.7°C, with an average minimum of 4.7°C. Average July temperature was 15.6°C, with an average maximum of 22.3°C (Ziemer 1996). The frost-free season ranges from 290 to 365 days. Mean annual precipitation from 1962 through 1997 was 1,190 mm, with a range from 305 to 2,007 mm. Ninety percent of the total annual precipitation falls between October and April. The frequent occurrence of summer coastal fog makes a small, but unknown, contribution to the total precipitation in the form of fog drip. Snowfall is rare at these low elevations in this region.

Vegetation

The forest vegetation of this coastal region is the product of favorable climatic and soil conditions. The area supports dense stands of second-growth Douglas-fir (*Pseudotsuga menziesii* (Mirb.) Franco), coast redwood (*Sequoia sempervirens* (D. Don) Endl.), western hemlock (*Tsuga heterophylla* (Raf.) Sarg.), and grand fir (*Abies grandis* (Dougl. ex D. Don) Lindl.). There are also minor components of hardwoods, including tanoak (*Lithocarpus densiflorus* (Fook. and Arn.) Rohn) and red alder (*Alnus rubrus* Bong.), and scattered Bishop pine (*Pinus muricata* D. Don). A few old-growth redwoods remain within the Caspar Creek watershed. The timber stands average 700 m³ ha⁻¹ of stem wood.

Understory vegetation includes evergreen huckleberry (*Vaccinium ovatum* Pursh), Pacific rhododendron (*Rhododendron macrophyllum* D. Don), and sword fern (*Polystichum munitum* (Kaulf.) Presl.).

The South Fork Phase Study Design

The initial South Fork study was designed as paired watersheds. Both watersheds are initially untreated until sufficient data have been accumulated to allow the variable(s) of interest to be predicted from the control watershed (Thomas 1980). One watershed was then logged and the other remained unlogged as a control. The South Fork was chosen to be the treated watershed because it had older and larger second-growth timber stands

while the North Fork was designated to serve as the control (Preface, fig. 1, these proceedings).

Precipitation Monitoring System

Five standard manually-read rain gages were installed in both watersheds in 1961 (Tilley and Rice 1977). One weighing-type recording gage was placed near the confluence of the North and South Forks in fall 1962. A second recording gage was located near the North Fork weir in August 1964. These 8-inch recording gages could chart 7 days of rainfall data and were the primary system until 1989. The network was measured on a weekly basis through most of the South Fork study phase. Some gage locations were changed when the study transitioned into the North Fork Phase.

Streamflow, Suspended Sediment and Fisheries Monitoring System

Concrete broad-crested weirs with an inset 120° low-flow V-notch were constructed in both the North and South forks of Caspar Creek by November 1962 (Krammes and Burns 1973). Stream discharge data were collected throughout the South Fork phase (1962-1976) using A-35 stream recorders³ mounted on stilling wells. Suspended sediment data were collected with fixed-stage samplers mounted on the weirs. The watersheds were calibrated from 1963 through 1967. From 1978 through 1982, sediment sampling instrumentation was upgraded to a PS-69 automatic pumping sampler installed at each weir. Flow-proportional frequency controllers were added later to increase the efficiency of the sampling and to reduce the processing workload. All of the automatic sampling was supplemented and calibrated using DH-48 manual grab-samplers to perform depth-integrated hand samples. Several different sampling algorithms were used through 1984 to trigger the sampler, including sediment proportional, flow and time modes. Since 1983, ISCO pumping samplers have been the primary sediment sampling instrument.

In cooperation with the California Department of Fish and Game (DFG), a fish ladder and control dams for fisheries research (Kabel and German 1967) were completed in November 1962 on the South Fork, but not finished on the North Fork until August 1963. A counting weir was also installed 2.5 km upstream from the ocean in November 1964, but it was severely damaged during the December 1964 storm and was never used for any extended fish monitoring. DFG monitored the fisheries until 1964 and then discontinued its participation. PSW contracted with University of California at Davis to study fish habitat by monitoring stream bottom fauna before and after road building and logging in the South Fork (Anonymous 1963).

Debris Basin Measurements and Maintenance

Debris settling basins behind the weirs have been surveyed annually since 1962 to account for deposited suspended sediment and bedload. During the summer low-flow period, permanently placed pins are used for a sag tape measurement of about two dozen transects in each weir pond. Measurements from the current year are compared to the previous year to obtain the volume of sediment deposited.

Periodically these basins are drained and the sediment excavated so that the gaging accuracy of the weir is not diminished. The basins are surveyed before and after excavation. During the fifth clean-out, in 1988, core samples were taken to determine the grain-size of the deposited debris. Debris removal was initially accomplished by building a truck ramp over the weir so that heavy equipment could excavate and remove the debris. Eventually, an access road was built to the back of each debris basin to provide better access for sediment removal.

Road Construction

In summer 1967, about 6.8 km of logging roads were constructed near the canyon bottom in the South Fork. Of these, about 6 km were within 61 m of the stream, of which 2.3 km directly impinged on the stream channel. About 5 percent of the watershed was occupied by main line and spur roads (Wright 1985). Fill slopes, landings, and major areas of soil exposed by road-building were fertilized and seeded with annual ryegrass in September 1967, immediately after completion of the road. The following 3 years were used to evaluate the effects of road construction on streamflow and sedimentation (Krammes and Burns 1973).

Timber Harvesting

After the road evaluation phase, harvesting began in the South Fork in March 1971 and ended in September 1973 (Preface, fig. 1, these proceedings). Single-tree and small-group-selection silviculture was used with ground-lead tractor log yarding. Most of the landings were located near the canyon bottom. The watershed was divided into three sale units of approximately equal size. Starting in the most downstream unit, harvesting progressed upstream, one unit each year. In the first sale (Watershed #1), 60 percent of the timber volume was harvested over 101 ha. The Watershed #2 timber sale removed about 70 percent, covering another 128 ha. The final sale, Watershed #3, harvested about 65 percent of the timber from 176 ha. In total, about 153,000 m³ of timber were removed from the South Fork watershed (Tilley and Rice 1977). More than 15 percent of the watershed was compacted from skid trail, landing, and road construction. Skid trail construction accounted for more than half of that compaction, and road construction accounted for more than one-third (Wright 1985).

Landslide/Soil Erosion Surveys

CDF conducted a landslide survey in the South Fork during summer 1976. Soil displacements larger than about 50 m³ ha⁻¹ were measured. These data were compiled to estimate the soil displacement of mass movements occurring in the watershed in a post-logging state.

³ The use of trade or firm names in this publication is for reader information and does not imply endorsement by the U.S. Department of Agriculture of any product or service.

Similarly, PSW installed seven plots as part of a larger study to assess soil movement associated with various logging systems. The plot locations centered on existing landings, with additional transects to measure the cross-sectional area of rills, gullies, ruts, and cuts made for skid trails or roads.

The North Fork Phase

Conception and Planning

Planning for this phase of the study started in the late 1970's. Impetus for this study was to respond to new regulatory requirements, both at the federal and state levels, that significantly affected resource management activities. The National Environmental Policy Act (NEPA) and Public Law 92-500 mandated the consideration of "cumulative effects" as part of Environmental Impact Statements. The North Phase of the study was designed to quantitatively test the magnitude of cumulative watershed effects (CWE's) associated with suspended sediment, storm runoff volume, and streamflow peaks (Rice 1983).

Study Design

A system of 13 nested subwatersheds (Preface, fig. 2, these proceedings) was selected to quantitatively evaluate whether synergistic cumulative effects were occurring (*table 1*). These subwatersheds were selected on the basis of size and location to assist in tracing sediment through many sizes of watersheds. They ranged in size from 10 ha (BAN) to 384 ha (ARF). Eight are tributary non-nested subwatersheds. The DOL station gages a tributary containing one nested subwatershed (EAG). The remaining four are progressively larger nested mainstem gaged subwatersheds. The subwatersheds were named after people who lived and worked in the local area during the early logging era (with the exception of watershed Munn). The North Fork phase was designed to address the question: For any given intensity of storm and management impact, does watershed response increase with watershed area? Cumulative effects are discussed in a broader context by Reid (these proceedings).

Table 1—Subwatershed names, areas, and treatment chronology.

<u>Watershed</u>	<u>Gaging station</u>	<u>Drainage area (ha)</u>	<u>Harvest units subwatersheds</u>	<u>Year(s) logged</u>	<u>Year(s) burned</u>	<u>Year(s) of herbicide application</u>
Arfstein	ARF	384	B C G V E K J L	1989-91	1990-91	1993-96
Banker	BAN	10	B	1991		
Carlson	CAR	26	C	1991		
Dollard	DOL	77	E V	1990		
Eagle	EAG	27	E	1990-91	1991	1994-96
Flynn	FLY	217	G V E K J L	1989-90	1990-91	1993-96
Gibbs	GIB	20	G	1991	1991	1994, 96
Henningson	HEN	39				
Iverson	IVE	21				
Johnson	JOH	55	K	1989	1990	1993
Kjeldsen	KJE	15	K	1989		
Lansing	LAN	156	K J L	1989-90	1990	1993
Munn	MUN	16				
North Fork	NFC	473	All	1985-91	1990-91	1993-96

Precipitation, Solar Radiation, Air, and Water Temperature

Six rainfall monitoring sites were operated during this phase. Five of the sites had been monitored since 1962. An additional site was installed in 1987 on the northerly ridge of the North Fork watershed. Tipping-bucket rain gages replaced the recording weighing type gages in 1989 and provided greater resolution by electronically recording a measurement every 5 minutes. In 1990, the rain gages were improved again to allow instantaneous rainfall readings — that is, a data point is recorded at each tip of the bucket (0.01 inch of precipitation).

One solar radiometer, located on a regenerated south-facing clearcut unit in the middle fork of Caspar Creek near the Eagle subwatershed unit, has been operational for 10 years. Solar radiation was also monitored along the main stem of the North Fork in conjunction with the stream biology study (Bottorff and Knight 1996) to help assess the effects of logging on the stream community related to increased light. Eight solar radiometers were installed along a 100-m reach during a study of aquatic insects. At other sites, photographs of the effective canopy cover have been taken using a fisheye lens.

Air and water temperatures have been recorded at 0.5-hr or 1-hr intervals at 11 sites beginning in 1988.

Streamflow and Suspended Sediment Measurements

Parshall flumes were chosen as the primary gaging design to measure streamflow and sediment in the tributary watersheds. This design has the advantage of allowing sediment to pass through the gaging station unobstructed and is engineered so that little calibration is required to calculate streamflow from stage readings. The design of the floor and side-wall keeps most of the sediment in suspension so that it can be sampled using pumping samplers. The flumes were custom-sized to handle the expected range of discharge in each subwatershed. They were constructed from old-growth redwood lumber that was milled at the CDF/CDC Parlin Fork Conservation Camp and pre-fabricated at the CDF/CDC Chamberlain Creek Conservation Camp cabinet shop. The flume components were hand-carried to each designated gaging location, reassembled, and installed on site.

For those subwatersheds that were too large to feasibly construct and install an appropriately-sized Parshall flume, natural channel-bottom rated sections were installed. These consisted of parallel plywood sidewalls erected on each side of the channel and sized for the expected range of stream discharge. Discharge measurements were required at these stations to establish and periodically update the relationship between water height (stage) and discharge.

Four stream gages (ARF, FLY, IVE, and LAN) were operational by November 1983. Four more stations (DOL, EAG, GIB, and HEN) were fully operational by the following November. The four remaining stations (BAN, CAR, JOH, and KJE) were not operational until January 1985, because of delays in acquiring the necessary

equipment. An additional control station (MUN) was completed in September 1985. Because of the scattered start-up times and the time required to install and troubleshoot new sampling technology, most of the analyses begin with hydrologic year 1986.

Sampling Development and Design

Critical to the success of obtaining unbiased estimates of suspended sediment loads at these remote sites were the development and implementation of a new sampling technology. In these small forested watersheds, high-discharge flows occur relatively infrequently, but carry a disproportionate part of the sediment. Traditional methods of sampling suspended sediment give biased estimates of total sediment yield and do not allow valid estimation of error (Thomas 1980). SALT (Selection At List Time) and related methods had been in use in forest sampling (e.g., 3P cruising) for many years, but research statistician Robert Thomas successfully modified the method for use in sampling suspended sediment loads (Thomas 1985).

SALT Sampling Hardware and Process

The initial station equipment (*fig. 1*) consisted of a 12-volt battery-powered system that included portable computer, interface circuit board, pressure transducer, ISCO pumping sampler, and a backup stage chart-recorder with an event marker (Eads 1987).

RSL (PSW Redwood Sciences Laboratory) also designed an interface circuit board that could convert input data from a stage-sensing device — the pressure transducer (*fig. 2*) — and also produce an output signal to the pumping sampler to collect a pumped sample. The electronic data storage and transfer functions eventually used a more powerful portable computer — the HP-71B — that the field crews carried with them. The data were archived on other media and sent via modem to the mainframe computer at the Redwood Sciences Laboratory.

Staffing requirements were high for equipment maintenance and data retrieval even with the sophisticated sampling schemes. During the full-scale monitoring period, up to 16 people might be involved in alternating 12-hour shifts during storm periods. The

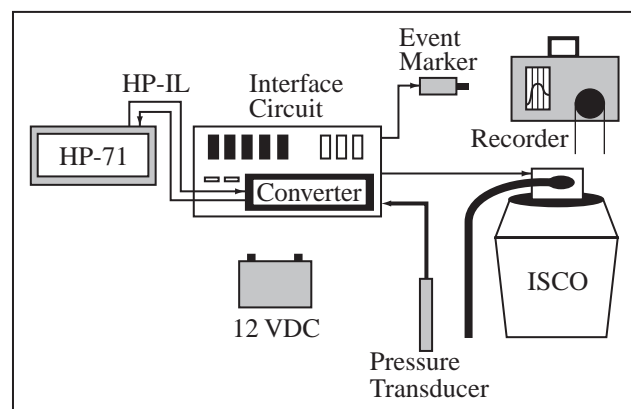

Figure 1 — Station equipment setup.

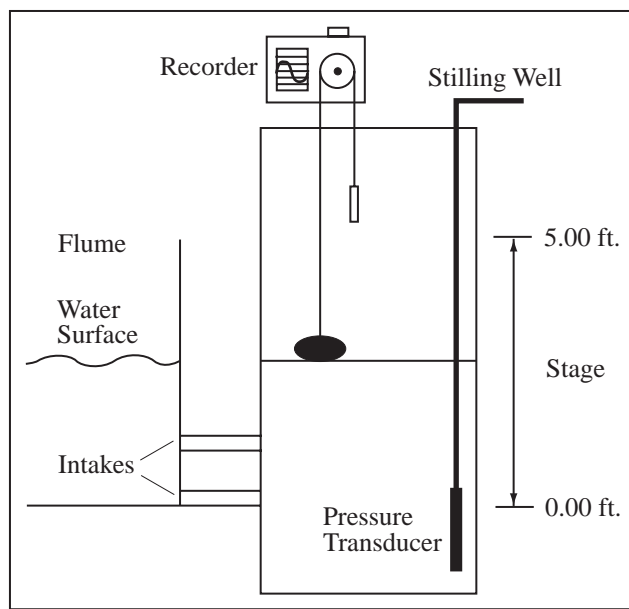

Figure 2 — Stage sensing device.

watershed was divided into sections and 3 to 4 two-person crews would cover their assigned stations, retrieving data from the computers and replacing the full sample bottles. Troubleshooting was an important function to ensure that the system was working properly. Corrosion of terminals, low voltages, and clogged intakes were some of the common problems that had to be dealt with immediately to minimize the loss of data during these important storm flow periods.

Long-Term Monitoring

The long-term monitoring phase of the study began in water year 1996 and ushered in a new sampling scheme that relies on real-time turbidity data to drive the sampling process. Experience has shown that the excellent relationship between suspended sediment and turbidity can reduce the sampling effort considerably (Lewis 1996). Results have shown that the relationship between sediment concentration and turbidity has been generally linear and has little scatter for a given station and storm. The current turbidity-based sampling system collects in-stream turbidity measurements every 10 min at eight stations. This approach has reduced the number of samples to about one-sixth of the number needed under a SALT sampling regime.

Harvesting Activities

The first harvest entry into the North Fork watershed occurred in spring 1985 (Preface, fig. 2, these proceedings). The Caspar West 85 timber sale was located in a subwatershed just upstream from the North Fork weir. About 64 ha, spread over two units, were harvested in this sale. More than 90 percent of the area was clearcut with the remaining area being selectively cut stream buffers. About 52 ha were cable logged and 12 ha were tractor logged near ridgetops.

Nearly 2 km of new haul road were constructed near the ridgetop as part of this sale, primarily to provide cable-yarding access. This area was logged independently of the CWE timber sales. Initial information about this area had indicated that the soils were not similar to the rest of the watershed. However, later investigation indicated otherwise.

After about 4 years of pretreatment stream monitoring, harvesting activities began in the North Fork CWE study area (table 1). Felling began in spring 1989 on the Caspar East Timber Sale — the first of three timber sales planned as part of this study phase. The upper three units (J, L, and K) were logged as part of this sale. A steady progression of harvest-related activities allowed the completion of this first sale by spring 1990 (table 1). Two units of the sale (J and L) were broadcast burned in fall 1990 to reduce the fuel loading and to accommodate replanting.

To investigate the effects of burning on sedimentation, units E and G were burned in the fall/winter period after harvesting was completed. Units C and K were designated non-burn units.

The second sale in the series was the 79-ha Rice 1990. This sale covered the middle third of the North Fork watershed in three separate clearcut units (E, G, and V). Felling for road construction began in April 1990. An unexpectedly large amount of precipitation in late May (more than 12 inches) affected some of the new road construction in and between units E and V, although no significant off-site impacts were detected. A small portion of unit V was yarded downhill. This is an unusual practice and was the only place where this occurred.

Tramway 1991 was the final and most downstream sale in the series. The sale was named after the historic tramway mentioned earlier in this paper. Remnants of this railway incline were protected as a documented archeological feature and are still visible today. Two of the clearcut subwatersheds (G and C) shared a divide, technically producing a cut unit larger than that allowed under Forest Practice Rules. The experiment required implementation of this sale design, so ultimately the timber harvest was permitted through a CEQA process and the Board of Forestry declared the North Fork an official experimental watershed. This sale was done very quickly, having started in September 1991 and completed by January 1992.

Table 2 shows how the subwatersheds were affected by the harvesting activities. The largest subwatershed, ARF, just above the North Fork weir, for example, had just over one third of its area affected by cable yarding and less than 10 percent affected by tractor logging. About one percent of this watershed is in new roads, and the total bare area created by new roads, landings, and skid trails is about 3 percent. About one quarter of the watershed area above station ARF was burned.

Other Studies or Treatments

Organic Step Mapping Study

This study was initiated to determine the mobility and dynamics of organic steps and debris within the main-stem and tributaries of the North Fork. Results will be used to estimate the availability of sediment storage sites and the buffering capability of channels following management activities.

The main-stem channel system had been mapped in 1984 at a scale of 1:500, whereas the tributaries were mapped at 1:250. Bank characteristics, gravel bars, rock outcroppings, and live and dead organic material were mapped. Each organic step (debris dam) having a minimum height of one foot and storing a sediment volume of at least 5 cubic feet is mapped and assigned a number and condition rating. Channels have been remeasured annually during the summer low-flow period.

Large Event Survey

An important sediment contribution to the channel can be large erosion features that most often occur during storms. Erosion

events exceeding 10 cubic yards were surveyed after most storms. A sketch is made of each landslide, and its location is identified on the detailed watershed map.

Subsurface Study

A study of subsurface drainage patterns before and after logging was initiated in a 0.81-ha portion of a swale in the K unit in 1987. Piezometers were installed to bedrock in multiple locations with depths varying from 1.5 to 8 m. Tensiometers were placed at 1.2 m and 1.5 m depths. The instruments were placed along five separate hillslope segments having straight, concave, and convex contours (Keppeler and others 1994).

Table 2—Percentage of each subwatershed affected by various treatments.

Watershed	Gaging station	Cutarea (percent)	Cable (percent)	Tractor (percent)	Thinned (percent)	WLPZ (percent)	WLPZcut (percent)	NewRoad (percent)	NewLndg (percent)	Skid trails (percent)	Total Bare Gnd (percent)	Total burned (percent)
Arfstein	ARF	45.5	35.1	7.1	0.1	4.2	1.4	0.9	0.9	0.8	2.9	24.0
Banker	BAN	95.0	77.3	13.4	0	5.3	1.7	1.3	1.3	0.6	3.2	0
Carlson	CAR	95.7	82.1	9.2	0	5.6	1.7	0.9	1.9	1.5	4.4	0
Dollard	DOL	36.4	27.4	5.9	0.6	0.4	0	1.6	0.9	0.8	3.7	33.9
Eagle	EAG	99.9	79.0	15.4	1.8	1.1	0.1	2.6	2.3	2.3	8.5	97.8
Flynn	FLY	45.4	34.6	7.6	0	4.3	1.6	0.7	0.9	0.8	3.0	30.4
Gibbs	GIB	99.6	54.9	39.4	0	2.0	1.2	2.0	2.2	2.8	7.9	98.2
Henningson	HEN	0										
Iverson	IVE	0										
Johnson	JOH	30.2	26.4	1.3	0	1.3	0.5	1.0	1.0	0.1	2.1	0.1
Kjeldsen	KJE	97.1	85.2	3.9	0	4.4	1.6	3.1	3.4	0.4	6.9	0
Lansing	LAN	32.2	27.8	1.9	0	4.1	1.5	0.4	0.6	0.3	1.9	20.3
Munn	MUN	0										
North Fork	NFC	49.6	38.6	7.6	0.1	4.1	1.4	1.0	1.0	0.8	3.2	19.5

NOTE:

- Cutarea** Cable + Tractor + Thinned + WLPZcut + NewRoad + NewLndg
- Cable** clearcut and yarded by cable
- Tractor** clearcut and yarded by tractor
- Thinned** thinned watershed areas (logged by tractor)
- WLPZ** water and lake protection zone
- WLPZcut** WLPZ times proportion of volume removed from WLPZ
- NewRoad** road surfaces, cuts, and fills (excludes old main haul roads)
- NewLndg** landing surfaces, cuts, and fills
- Skid Trails** skid trail surfaces, cuts, and fills
- Total Bare Gnd** NewRoad + NewLndg + Skid Trails + firelines
- Total Burned** broadcast burns

Bedload Study

Quantitative information on bedload rates and patterns of movement is an important addition to the overall knowledge about sedimentation effects from harvest activities. One objective of this study was to refine and calibrate a bedload measurement technique for use in small to medium-sized forested catchments with flashy hydrographs (Albright and others 1987). The Birkbeck-type sampler consists of a cast concrete form (pit), 0.6 m on a side, with a removable top cover that is horizontally level with the stream bed. Removable metal boxes inside the concrete forms collect the bedload material that passes through a 0.1-m-wide slot. Four of these pits were installed at Station ARF. Bedload transport rates were initially monitored by a hydraulic system using a pressure transducer to sense pressure in a fluid-filled pillow and a data logger to record the pressure. Each pressure pillow and transducer were soon replaced by a load cell that produces a voltage that, when interrogated by the data logger, is proportional to the submerged weight of the box (Lewis 1991). Collected material was removed after each storm. A fixed I-beam was used for winching the full boxes from the concrete pits. A sump pump was used to empty the boxes during a storm. Some of this bedload material was sieved for grain-size analysis. For a measure of total annual bedload, detailed surveys of the bedload delta at the upper end of the North Fork debris basin were completed each year from 1989 to 1995.

Low Flow Study

Much of the summer low flow in the tributaries is subsurface through porous gravel. To measure summer low flow, slotted polyvinylchloride (PVC) pipes were buried in the streambed with a pressure transducer that was interrogated periodically by an HP-71B data logger (Keppeler 1986).

Aquatic Invertebrate Biological Studies

The objective of the North Fork Caspar Creek biological study was to determine whether logging treatments (1989-1991) within the drainage basin caused changes in three components of stream structure and function: (1) the benthic macroinvertebrate

community; (2) leaf litter processing rates; and (3) the benthic algal community (Bottorff and Knight 1996).

Water Chemistry and Quality

The primary purpose of this research was to examine the effects of forest harvest and post-harvest management practices on biogeochemical processes. Results provide information to understand the complex interactions that occur in nutrient cycling processes at the ecosystem scale (Dahlgren 1998).

Aquatic Vertebrate Biological Studies

Since the mid-1980's, fisheries research has been examining the relationships between timber harvest, aquatic habitat, and vertebrate populations.

Aerial Photography

Two flights have been made over the Caspar watershed to produce large-scale (1:6000) color photographs of the study area. The first was completed in summer 1988 to document the watershed condition before harvest. The second flight was completed in summer 1992 to document the condition of the logged watershed. These aerial photos were used in timber sale planning and, later, in geomorphic mapping both the North and South Forks.

Vegetation Management Treatments

Although not part of the initial study design, several types of vegetation management treatments were applied to a number of units at various times. To reduce the competition from both native and exotic plant invaders, herbicide applications were used in units J, G, E, and V. The chemicals have all been applied with hand-operated backpack sprayers using either a directed-broadcast or a directed-spot treatment. A one percent formulation of Garlon 4 herbicide was used in these two types of application. Precommercial thinning has also been used, although, to date, only in units Y and Z as part of the 1985 Caspar West timber sale. The other cut units are planned to receive these treatments as needed to foster rapid regrowth of commercially-desirable forest vegetation.

References

- Albright, J.S.; Lisle, T.E.; Thomas R.B. 1987. **Measurement of bedload pattern and rates in a small coastal stream in northwestern California.** Unpubl. study plan. Arcata, CA: Redwood Sciences Laboratory, Pacific Southwest Forest and Range Experiment Station, Forest Service, U.S. Department of Agriculture; 5 p.
- Anonymous. 1964. **Second progress report 1963-64, Cooperative watershed management in the lower conifer zone of California.** Berkeley, CA: Pacific Southwest Forest and Range Experiment Station, Forest Service, U.S. Department of Agriculture; 19 p.
- Bottorff, R.L.; Knight, A.W. 1996. **The effects of clearcut logging on stream biology of the North Fork of Caspar Creek, Jackson Demonstration State Forest, Fort Bragg, CA—1986 to 1994.** Unpubl. Final Rept. prepared for the Calif. Dept. of Forestry and Fire Protection, Contract No. 8CA3802. Sacramento, CA. 177 p.
- Dahlgren, R.A. 1998. **Effects of forest harvest on biogeochemical processes in the Caspar Creek Watershed.** Unpubl. Draft Final Rept. prepared for the Calif. Dept. of Forestry and Fire Protection. Contract No. 8CA17039. Sacramento, CA. 151 p.
- Eads, R.E. 1987. **Instrumenting and operating SALT: A training manual, Section 1.** Unpubl. manual. Arcata, CA: Redwood Sciences Laboratory, Pacific Southwest Forest and Range Experiment Station, Forest Service, U.S. Department of Agriculture; 33 p.
- Kabel, C.S.; German, E.R. 1967. **Caspar Creek study completion report.** Marine Resources Branch Administrative Report No. 67-4. Sacramento CA: The Resources Agency, Calif. Dept. of Fish and Game; 27 p.
- Keppeler, E.T. 1986. **The effects of selective logging on low flows and water yield in a coastal stream in northern California.** Arcata, CA: Humboldt State University; 137 p. M.S. thesis.
- Keppeler, E.T.; Ziemer, Robert R.; Cafferata, P.H. 1994. **Changes in soil moisture and pore pressure after harvesting a forested hillslope in northern California.** In: Marston, R.A.; Hasfurther, V.R., eds. *Effects of human-induced changes on hydrologic systems*; 1994 June 26-29; Jackson Hole, WY. Herndon, VA: American Water Resources Association; 205-214.
- Krammes, J.S.; Burns, D.M. 1973. **Road construction on Caspar Creek watersheds — a 10-year progress report.** Res. Paper PSW-93. Berkeley, CA: Pacific Southwest Forest and Range Experiment Station, Forest Service, U.S. Department of Agriculture; 10 p.
- Lewis, J. 1991. **An improved bedload sampler.** In: Fan, S.; Kuo, Y.H., eds. *Fifth Federal Interagency Sedimentation Conference Proceedings*; 1991 March 18-21; Las Vegas, NV. Washington, DC: Federal Energy Regulatory Commission; 6-1 to 6-8.
- Lewis, J. 1996. **Turbidity-controlled suspended sediment sampling for runoff-event load estimation.** *Water Resources Research* 32(7): 2299-2310.
- Napolitano, M.B. 1996. **Sediment transport and storage in North Fork Caspar Creek, Mendocino County, California: water years 1980-1988.** Arcata, CA: Humboldt State University; 148 p. M.S. thesis.
- Rice, R.M. 1983. **Caspar Creek Study, Supplement 1 – The effects of combined cable/tractor logging on the sediment regime and on total water and sediment output.** Study 3.152 Caspar Creek Sediment Routing, Phase 1: Preliminary Reconnaissance Plan. Unpubl. study plan. Arcata, CA: Redwood Sciences Laboratory, Pacific Southwest Forest and Range Experiment Station, Forest Service, U.S. Department of Agriculture; 13 p.
- Thomas, R.B. 1980. **Caspar Creek Study, Supplement 1 – The Effects of combined cable/tractor logging on the sediment regime and on total water and sediment output.** FS-PSW-1651. Unpubl. study plan. Arcata, CA: Redwood Sciences Laboratory, Pacific Southwest Forest and Range Experiment Station, Forest Service, U.S. Department of Agriculture; 16 p.
- Thomas, R.B. 1985. **Estimating total suspended sediment yield with probability sampling.** *Water Resources Research* 21(9): 1381-1388.
- Tilley, F.B.; Rice, R.M. 1977. **Caspar Creek watershed study—a current status report.** State Forest Notes No. 66. Sacramento, CA: State of Calif., Department of Forestry; 15 p.
- Wosika, Edward Pearson. 1981. **Hydrologic properties of one major and two minor soil series of the Coast Ranges of northern California.** Arcata, CA: Humboldt State University; 150 p. M.S. thesis.
- Wright, Kenneth A. 1985. **Changes in storm hydrographs after roadbuilding and selective logging on a coastal watershed in northern California.** Arcata, CA: Humboldt State University; 55 p. M.S. thesis.
- Ziemer, R. 1996. **Caspar Creek streamflow and sediment records: 1963-1995.** CD-ROM, 200 MB. 1996 July. Arcata, CA: Pacific Southwest Research Station, Forest Service, U.S. Department of Agriculture, and Fort Bragg, CA: California Department of Forestry and Fire Protection.

Why Caspar Creek — Then and Now?¹

Raymond M. Rice²

Abstract: *The results of every watershed experiment are a unique combination of the site, the weather, the questions asked, the quality of the data produced, and the quality of the analysis made of those data. These results narrow the scope of the environmental debate, but they will not alter the value systems of the debaters. By availing themselves of the available scientific information, both sides can make their cases more persuasive to the courts, to the regulators, and perhaps to the public.*

Then

Before getting into what is important about Caspar Creek, I would like to inject a few ideas that consumers of watershed research should keep in mind. Sometimes when a study is completed we find that the weather did not cooperate, some of our ideas were not too bright, and some of our interpretations of the data were wrong. That is the first lesson to carry away from this discussion. The results of every watershed experiment are a unique combination of the site, the weather, the questions asked, the quality of the data produced, and the quality of the analysis made of those data. Those factors have to be kept in mind when using results from experimental watersheds—or any other research—to guide action. The second lesson is that, if these results are ever going to be applied, the products of watershed research have to fit with the objectives of potential users. This is one of the most difficult problems in watershed research. We need to forecast problems at least a decade in the future. Sometimes we will get it wrong. If we do, remember lesson three: hang on to old data. It may be useful later or somewhere else. In fact, some of the oldest Caspar Creek data are still being used in current studies.

Lesson number four is: do not worry about the “we don’t do it that way anymore” alibi. The first Caspar Creek experiment (Rice and others 1979) was completed just as forest practice rules were changing dramatically. The findings, that poor logging practices and Murphy’s Law were responsible for nearly a threefold increase in sediment, were rejected as inapplicable by a hydrologist working in the Navarro River watershed. At about the same time, Caspar Creek findings were being applied in the Panama Canal Zone. Lesson number four holds true because, like beauty, applicability is in the eye of the beholder.

¹ An abbreviated version of this paper was presented at the Conference on Coastal Watersheds: The Caspar Creek Story, May 6, 1998, Ukiah, California.

² Formerly Chief Research Hydrologist, Pacific Southwest Research Station, USDA Forest Service, Arcata, California, and now retired. Current address: 44 Robert Court East, Arcata, CA 95521. (ray@northcoast.com)

All of the foregoing may make it appear that watershed research is a pretty marginal thing and that its practical application is a matter of chance. Before writing off experimental watershed studies, remember that other types of studies share most of the same limitations. Experimental watersheds have some distinct advantages not shared by other types of investigations. They are big—not big enough to suit many of us—but bigger than the competition. They are mini-ecosystems that permit the physical and biological interactions to be studied in a controlled environment. As a consequence, scientists conducting watershed experiments have a better chance of correctly identifying cause and effect. Another big advantage of watershed experiments is that they take a long time, yielding a video—not a snap shot—of whatever is being studied. Lastly, experimental watersheds, being dedicated to research, provide a secure and supportive environment that attracts other studies not even envisioned when they are established.

In spite of the benefits just enumerated, experimental watershed experiments are still, in essence, anecdotal regardless of the sophistication of their instrumentation or analyses. However, many of the studies are looking at physical processes, and physics does not change that much from place to place and from time to time. For example, consider the fears that logging will increase large floods. From the data in the first experiment in the South Fork of Caspar Creek, Bob Ziemer (1981) concluded that logging about half the timber volume did not have a significant effect on important peak flows. Later, Ken Wright (1985) looked at the South Fork data and seven additional studies that evaluated large winter peak flows from logged watersheds on the Pacific coast. He found that one study showed a decrease, two showed an increase, and five found no change in large peak flows associated with logging. It would appear that Ziemer had it right.

Now

Back in the Dark Ages—in the fall of 1959 when Bob Ziemer and I were students in Paul Zinke’s Forest Influences class at the University of California at Berkeley—I asked Dr. Zinke about the future of watershed management. He replied that it would not amount to anything until people started getting into trouble. I found that very disconcerting. There I was doing watershed management research—and nobody cared!

It turns out that Paul Zinke was, indeed, a prophet. In 1990, less than a year after my retirement, I found myself doing my first analysis for a timber company. Why was that company in trouble? Not because the company was doing a lousy job of logging. Quite the contrary, its practices were exemplary. But, it was operating in a semi-urban area, and the political and regulatory environment had

changed. The environmental movement of the 1970's had produced a spate of laws and regulations that affected forest operations. I believe that my employment in 1990 was the result of environmentalists having discovered the utility of questioning the analysis of cumulative watershed effects (CWE's) in timber harvest plans. CWE's were a marvelous tool for questioning whether water quality was being protected. First of all, the term was not adequately defined in law or regulation. This left a lot of room for interpretation by the courts. Second, CWE's are hard to evaluate with any great certainty. This means that even well-qualified people can come to contrary views about how aquatic resources will be affected by a proposed action or have been affected by past activities.

Since my 1990 introduction to the watershed consulting business I have been involved in seven more analyses, all of which drew on Caspar Creek results to one degree or another. I have also ended up in court four times. Hopefully, the information coming out of the present study of CWE's in the North Fork of Caspar Creek will provide some definitive information about their nature in this particular environment. It will still be subject to my four "lessons" but it will be the best quality data that I know of on the subject. We will hear more about that as the day progresses. With luck, these North Fork findings will move some of the contention about CWE's from the legal arena to the scientific arena. From the foregoing it must be clear to you that I am sold on the desirability of past and future watershed studies. But, what can they do for you? It was my charge to discuss three arenas: the political, the regulatory, and the environmental.

The Political Arena

Sadly, I do not think that watershed research can help much in affecting the political aspects of forest management disputes. Political differences arise, I think, mainly from demographics. The nation is becoming more and more urbanized. City people miss the trees, streams, and lakes that they assume are part of their birthright. More than 100 years ago, the Adirondack Forest Preserve was established in upstate New York, mainly by the votes of New York City residents. Most of those voters would never visit the Preserve; they just wanted to know it was there. A few years ago I contrasted the forest practice regulations of California, Washington, Oregon, and Alaska (Rice 1992). As expected, the degree of governmental oversight of forest practices followed that order, as did the degree of urbanization of those states.

The results of watershed experiments may narrow the scope of debate, but they will not alter the value systems of the debaters. That reasonable people can have widely different views on what constitutes prudent stewardship of a forest is often overlooked by both sides of the debate. To oversimplify: industry views its land as a tree farm whose management should be as free of infringement on an owner's property rights as a wheat farmer's. Environmentalists—and to a large extent the general public—view the owners of forest land as custodians of natural resources who should be subjected to public oversight. Aggravating the conflict of world views is the reluctance of politicians to avail themselves of the science that there

is to quantify opposing values and strike a balance that is in the public's interest. That is what I call the "how many salmon eggs per board foot" problem.

The Regulatory Arena

The regulatory arena is where experimental watershed findings can have the most impact on forest management. This is especially true for Forest Practice Regulations. They are developed and administered by people familiar with forest industry and who often have scientific training. As a consequence, regulators are more receptive to quantitative data and statistical inferences from such data. Even so, rules and their enforcement are still often compromises between competing value systems. Nonetheless, this is the arena in which hard data have the best opportunity to affect forest management.

The courts are the other element in the regulatory arena. However, their ability to foster good forest management is limited by the extent to which good science has been incorporated into the laws at issue. In my limited experience I have found courts receptive to testimony based on research data. However, a trial is also a contest between lawyers; therefore, the outcome can hinge on the quality of the competing attorneys. The flip side of that is that it is unlikely that an attorney can rescue sloppy testimony or scientifically challengeable data or inferences.

The Environmental Arena

Watershed research plays two valuable roles in the environmental arena. First, by its findings, it can serve to guide forest practices by linking causes to effects. Such information can tell regulators and forest managers what should be changed to accomplish particular goals. Second, by measuring effects, it can put them in perspective (is the sky falling?). When studies measure the effect of different practices having similar objectives it is possible to weigh opposing practices quantitatively. We will see an example of this today as the results of the North Fork study are contrasted with those measured in the South Fork study more than 20 years ago.

Regrettably, much of what goes on in the environmental arena will remain a combat between the two value systems. Even here, both sides can benefit from findings from experimental watershed research. It does not help an environmentalist's case much to have his comfortable flood peak theory skewered by Ken Wright's review of the relevant data. And the forest industry's credibility is not improved by asserting that there is no erosion or sediment risk associated with logging. By availing themselves of the available scientific information, both sides can make their cases more persuasive to the courts, to the regulators, and *perhaps* to the public. To the extent that this occurs, the environment is improved because actions will be based more on reality and less on rhetoric. That is the importance of the Caspar Creek Experimental Watershed. It is needed to help ensure that forest management and environmental protection have the benefit of the best science available.

References

- Rice, R.M. 1992. **The science and politics of BMP's in forestry: California experiences.** In: Naiman, R.J., ed. *Watershed management: balancing sustainability with cumulative environmental change.* New York: Springer-Verlag; 385–400.
- Rice, R.M.; Tilley, F.B.; Datzman, P.A. 1979. **A watershed's response to logging and roads: South Fork of Caspar Creek, California, 1967-1976.** Res. Paper PSW-146. Berkeley, CA: Pacific Southwest Forest and Range Experiment Station, Forest Service, U.S. Department of Agriculture; 12 p.
- Wright, Kenneth A. 1985. **Changes in storm hydrographs after roadbuilding and selective logging on a coastal watershed in northern California.** Arcata, CA: Humboldt State University; 55 p. M.S. thesis.
- Ziemer, Robert R. 1981. **Stormflow response to roadbuilding and partial cutting in small streams of northern California.** *Water Resources Research* 17(4): 907-917.

Flooding and Stormflows¹

Robert R. Ziemer²

Abstract: *The effects of road building and timber harvest on storm flow were evaluated at the North and South Forks of Caspar Creek in north coastal California. From 1963 through 1975, a total of 174 storms that produced peak discharges larger than $0.016 \text{ L s}^{-1}\text{ha}^{-1}$ in the untreated North Fork were studied. Storms producing flows this size and larger occur about 14 times each year and about 10 percent of the time. They are responsible for 83 percent of the annual water discharge and transport 99 percent of the suspended sediment. Selection cutting and tractor yarding second-growth redwood and Douglas-fir in the 424-ha South Fork did not significantly change peak streamflows that occur about eight times a year — those larger than about $1 \text{ L s}^{-1}\text{ha}^{-1}$. For flows smaller than $1 \text{ L s}^{-1}\text{ha}^{-1}$, the first peaks in the fall increased by 300 percent after logging. The effect of logging on peak flow was best predicted by the percent of area logged divided by the sequential storm number, beginning with the first storm in the fall. For example, the second storm of the fall produced half the response to logging than the first storm. In 1985, the second stage of the Caspar Creek study began with the installation of an additional 13 gaging stations in the North Fork. From 1985 through 1996, 59 storms and 526 peak flow events were measured. There was a mean peak flow increase of 35 percent in entirely clearcut and 16 percent in partially clearcut tributary watersheds for the class of flows greater than $4 \text{ L s}^{-1}\text{ha}^{-1}$ — those that occur less frequently than twice a year. When the unlogged South Fork was used as the control, peak streamflows in the North Fork after clearcut logging were not significantly larger for flows greater than about $1 \text{ L s}^{-1}\text{ha}^{-1}$, as was also observed after selection cutting the South Fork. However, when the more sensitive uncut North Fork tributaries were used as controls, an increase in peaks was detected at the North Fork weir after logging.*

Debate over the beneficial influence of forests in protecting against floods has continued in the United States for at least a century. Some believe that flooding problems can be solved by proper forest conservation, whereas others maintain that forests do not reduce flooding. The arguments being made today are not unlike those made in the past. For example, Chittenden (1909) stated that forest cutting alone does not result in increased runoff. But, concern about overexploitation of forests and the argument that conservation could reduce floods resulted in passage of Weeks' Law in 1911. Weeks' Law authorized the purchase of private land to establish National Forests in the eastern United States "... for the protection of the watersheds of navigable streams..."

During the early part of the 20th century there were many opinions but little data to test the relationship between forests and floods. To address these varied opinions, watershed research was

initiated in the 1930's at experimental watersheds in southern California (San Dimas), Arizona (Sierra Ancha), and North Carolina (Coweeta). The studies at Coweeta produced the first scientific evidence that converting a forest into a mountain farm greatly increased peak flows, but clear-cutting the forest without disturbing the forest floor did not have a major effect on peak flows (Hoover 1945). By the 1960's, there were 150 forested experimental watersheds throughout the United States. When Lull and Reinhart (1972) released their definitive paper summarizing what was known about the influence of forests and floods, about 2,000 papers had been published reporting research results about the hydrology of forested watersheds. Lull and Reinhart (1972) focused on the eastern United States. A decade later, Hewlett (1982) studied the major forest regions of the world to answer the question "Do forests and forest operations have sufficient influence on the flood-producing capacity of source areas to justify restrictions on forest management?" Hewlett concluded, as did Chittenden (1909) and Lull and Reinhart (1972), that the effect of forest operations on the magnitude of major floods "is apt to be quite minor in comparison with the influences of rainfall and basin storage." Subsequent studies have resulted in similar conclusions.

Caspar Creek Watershed Study

In 1955, the largest regional storm of the previous 50 years produced great damage in recently logged watersheds in northern California. Extensive damage to watersheds such as Bull Creek near Rockefeller Grove State Park in northwestern California resulted in public debate over the need for increased regulation of forest practices in California. A principal objective of initiating the Caspar Creek study in 1962 on the Jackson Demonstration State Forest, near Fort Bragg, California (Preface, fig. 1, these proceedings), was to examine the effect of improved logging practices being recommended at the time upon streamflow and sediment production (Henry, these proceedings).

The Caspar Creek study is unique in the western United States. While other experimental watershed studies in the West were evaluating the effects of logging old-growth virgin forests, none were studying second-growth forests. The old-growth redwood forest had been removed from Caspar Creek between 1860 and 1904 and, by the 1960's, the second-growth forest was commercially feasible to harvest. Soon, most of the previously logged forests in northwestern California, and eventually much of the West, would be in a condition suitable for reharvesting. By the early 1960's, it was becoming increasingly important to understand the hydrologic dynamics of managing second-growth forests.

¹ An abbreviated version of this paper was presented at the Conference on Coastal Watersheds: The Caspar Creek Story, May 6, 1998, Ukiah, California.

² Chief Research Hydrologist, USDA Forest Service, Pacific Southwest Research Station, 1700 Bayview Drive, Arcata, CA 95521; (rrz7001@axe.humboldt.edu)

Selective Logging

Stream gaging structures consisting of 120° V-notch weirs with concrete upper rectangular sections were constructed at the North and South Fork of Caspar Creek in 1962. Streamflow was measured at these weirs from 1963 to 1967, when both the North Fork and South Fork watersheds were in an “undisturbed” second-growth condition. That is, neither watershed had been logged since the old-growth forest was removed. A main-haul logging road and main spurs were constructed in the South Fork watershed in summer 1967 (Henry, these proceedings). In summer 1971, 59 percent of the stand volume was selectively cut and tractor yarded from the lower 101 ha of the South Fork. In summer 1972, 69 percent of the volume was removed from 128 ha in the middle, and, in summer 1973, 65 percent of the volume was removed from the remaining 176 ha in the upper South Fork (Preface, fig. 1, these proceedings).

To evaluate the effects of road building and timber harvest on storm flow, Ziemer (1981) tabulated data from 174 storms from 1963 through 1975 that produced peak discharges in the untreated North Fork larger than $0.016 \text{ L s}^{-1}\text{ha}^{-1}$. Storms producing flows this size and larger occur about 14 times each year and about 10 percent of the time. They are responsible for 83 percent of the annual water discharge, and transport 99 percent of the suspended sediment (Ziemer 1981). Wright and others (1990) increased the size of the smallest peak to $0.056 \text{ L s}^{-1}\text{ha}^{-1}$ and used several different hydrograph components to study 129 storms for these same years. Storm peaks within this range would occur on average about 10 times each year.

From these studies, only those peaks within the smallest flow class [$<0.67 \text{ L s}^{-1}\text{ha}^{-1}$ (Ziemer 1981); $<1.12 \text{ L s}^{-1}\text{ha}^{-1}$ (Wright and others 1990)] increased after logging. In addition, the largest changes in the South Fork's peak streamflow after logging were found to be for the first storms after lengthy dry periods. The first streamflow peaks in the fall increased by 300 percent after logging, but these early fall storms produced only small peak flows. Ziemer (1981) found that effect of logging on peak flow was best predicted by the percent of area logged divided by the sequential storm number, beginning with the first storm in the fall. For example, the second storm of the fall produced half the response to logging than the first storm. Selection cutting and tractor yarding the second-growth redwood and Douglas-fir forest in the 424-ha South Fork did not significantly affect peak streamflows larger than those that occur on average about 8 times a year. Further, there was no significant change in the largest peak flows (>10-year return interval) after selectively logging the South Fork (Wright and others 1990).

The peak flow data analyzed by Ziemer (1981) and Wright and others (1990) ended in 1975, only a few years after logging concluded in the South Fork. A fresh look at streamflow peaks in the South Fork was conducted by adding an additional 10 years of streamflow peaks to the analysis. For this analysis, pairs of North Fork and South Fork peaks larger than about $1 \text{ L s}^{-1}\text{ha}^{-1}$ were used. There were 58 pairs for the pre-logging period (fall 1962 through spring 1971) and 101 pairs for the post-logging period (fall 1971 through spring 1985). Based on this expanded data set, as with the earlier analyses, there was no significant difference between the regression lines of peak flows before and after logging the South Fork (fig. 1).

Clearcut Logging

Storm Peaks

The second stage of the Caspar Creek study began in 1985 with the installation of an additional 13 gaging stations in the North Fork (Preface, fig. 2, these proceedings). Four of these new stations were on the main stem, and nine were located on tributaries of the North Fork. The lowest three mainstem stations (ARF, FLY, and LAN) are rectangular plywood sections, rated by streamflow measurements. Streamflow at the fourth and uppermost mainstem station (JOH) and at the nine tributaries is measured using calibrated Parshall flumes.

From 1985 through 1996, 526 peak flow observations, representing 59 storms, were made at the 10 stations gaging treated watersheds. A comprehensive discussion of the analytical model and detailed statistical analysis of these data is nearing completion (Lewis and others 1998). The complete data set is available on compact disk (Ziemer 1998). Storm events were generally included in the study when the peak discharge at the South Fork weir exceeded $1.6 \text{ L s}^{-1}\text{ha}^{-1}$. Storms producing a discharge larger than $1.6 \text{ L s}^{-1}\text{ha}^{-1}$ occur about 7 times per year. A few smaller peaks were included in dry years. Multiple peak hydrographs were treated as multiple storms when more than 24 h separated the peaks and the discharge dropped by at least 50 percent in the intervening period. When multiple peak hydrographs were treated as a single storm, the peak corresponding to the highest peak at the North Fork weir was selected for the analysis. Thus, the same feature was used at all stations, even if that feature was not the highest peak on the hydrograph at all stations. However, differences in peak discharge caused by this procedure were very small.

To compare peak flow response from clearcutting in the North Fork with the earlier selective cutting in the South Fork, the same 58 pairs from the earlier study were used for the pre-logging period (fall 1962 through spring 1971). These peaks were compared to 40 pairs of peaks measured at the North Fork and South Fork weirs during the North Fork post-logging period (fall 1990 through spring 1996). Peak streamflows following clearcut logging behaved similarly to those observed after selection cutting in the South Fork; that is, no change was detected in peak streamflows larger than about $1 \text{ L s}^{-1}\text{ha}^{-1}$ at the weirs (fig. 2). However, using a different uncut control period (1985 to 1989) and the more sensitive uncut tributaries as the controls instead of the South Fork, an increase in peaks was detected ($p < 0.0025$) at the North Fork weir after logging.

Of the 526 storm peaks observed from 1985 through 1996, 226 represented peaks during the pre-treatment period from 1985 to 1989. The control watersheds HEN, IVE, and MUN correlated best with the watersheds to be treated. Higher correlation was obtained by using the mean of the combined peak flows from the control watersheds, rather than peak flows from any of the individual control watersheds. Because MUN was not monitored during the last year of the study, the mean of each peak from uncut watersheds HEN and IVE (designated HI) was chosen as the control for the peaks analysis.

When all 14 subwatersheds in the North Fork are analyzed together, there was a mean peak flow increase of 35 percent in those tributaries that were entirely clearcut and a 16 percent increase in those watersheds that were partially clearcut, for the class of flows

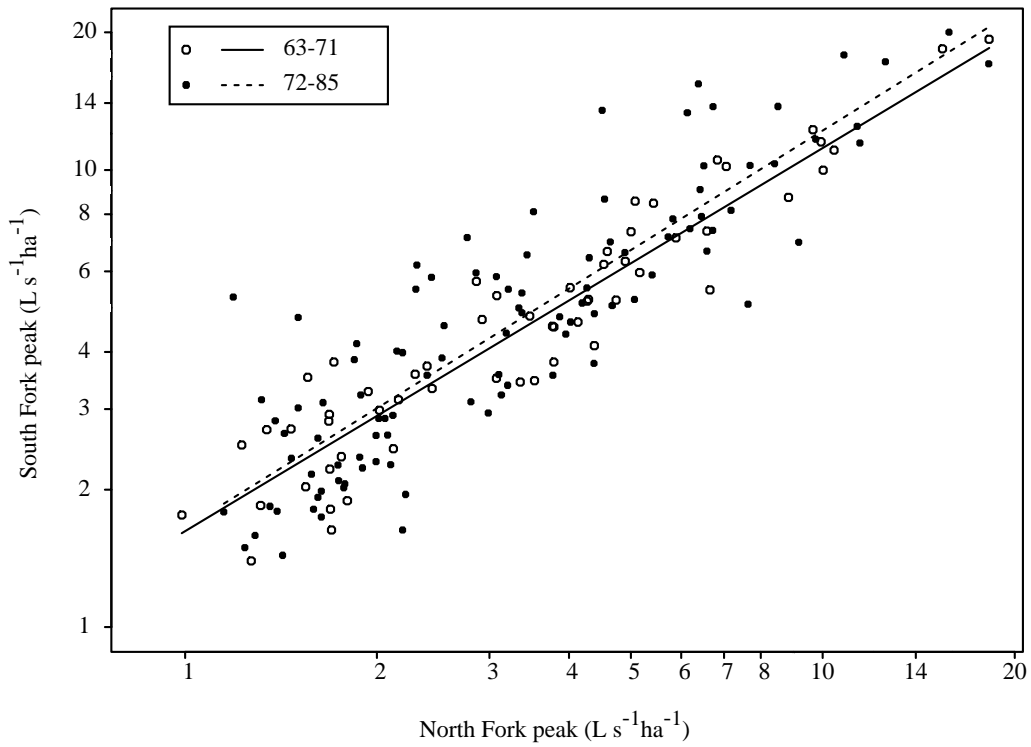

Figure 1 — Relation between peak streamflow in the South Fork of Caspar Creek, using the North Fork as a control. Pre-logging years were 1963-1971, post-logging years were 1972-1985. The two regression lines are not significantly different.

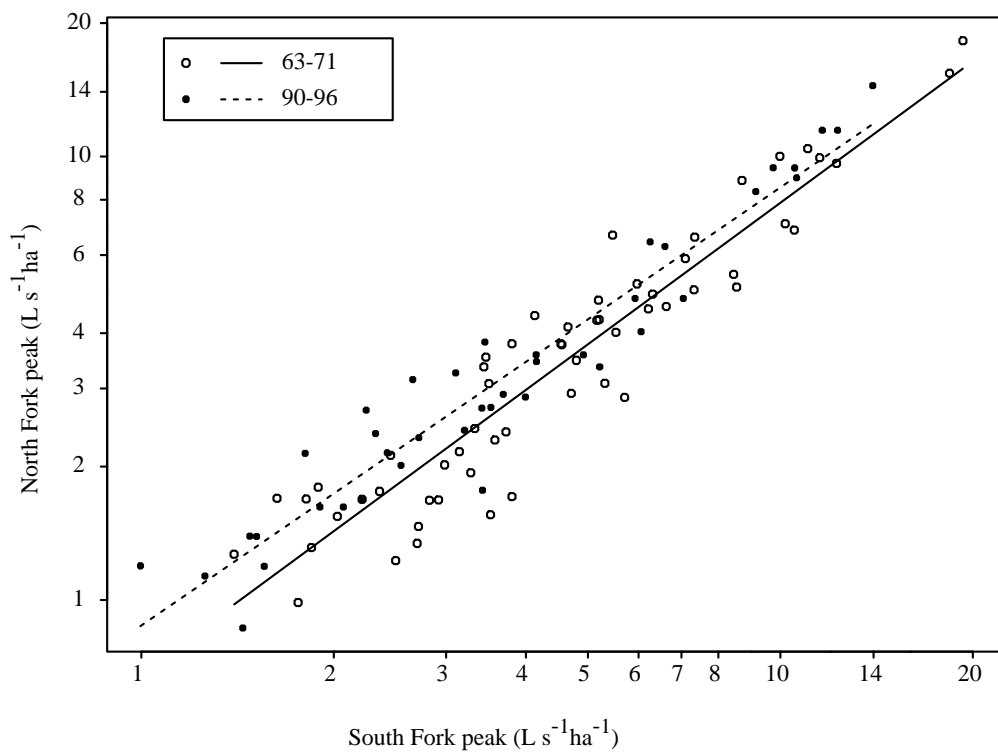

Figure 2 — Relation between peak streamflow in the North Fork of Caspar Creek, using the South Fork as a control. Pre-logging years were 1963-1971, post-logging years were 1990-1996. The two regression lines are not significantly different.

greater than $4 \text{ L s}^{-1}\text{ha}^{-1}$. Storms that produce peaks larger than $4 \text{ L s}^{-1}\text{ha}^{-1}$ occur about twice a year.

The Chow (1960) tests, based on this combined HI control, revealed strong evidence that post-treatment data differed from pre-treatment regressions. Regressions for 8 of the 10 treated watersheds, including the North Fork, departed ($p < 0.005$) from the pre-treatment regressions after logging commenced. The other two, FLY and LAN, located on the mainstem, had p -values less than 0.05. When the post-treatment data are fit by locally weighted regression (Cleveland 1993), it is clear that the greatest departures from the pre-treatment data are found for the small peaks in the 100 percent clearcut tributaries (fig. 3). However, even for the largest peaks, the post-logging departures are still positive. For the size of storm peak expected once every 2 years ($8 \text{ L s}^{-1}\text{ha}^{-1}$), there was an average increase of 27 percent for the 100 percent clearcut tributaries BAN, KJE, GIB, CAR, and EAG (21, 28, 39, 19, and 27 percent, respectively). As the size of the watershed increases and the proportion of the watershed logged decreases, the post-logging and pre-logging observations become more similar. However, for the same 2-year storm, the peak in the 50 percent cut NFC watershed increased by 9 percent after logging (fig. 3).

Seasonal patterns in the departures from the predicted peak were evident in most of the treated watersheds. For example, when the departures for watershed EAG are plotted against storm number, the largest departures occurred early in the season (fig. 4). The pattern is less pronounced in the absolute departures (fig. 4a) than in the departures expressed as a percentage of the predicted peak (fig. 4b). Storms 28 and 29 occurred shortly after 50 percent of

watershed EAG had been winter-logged, but did not show treatment effects, which indicates that the time since harvesting had been inadequate for soil moisture differences to develop between the control watersheds and EAG.

To evaluate the relationships between peak discharge and possible explanatory variables, an aggregated regression model was fit simultaneously to all of the subwatershed peaks (Lewis and others 1998). The overall model was grown in a stepwise fashion. An initial model with only an intercept and slope for each watershed was fit using least squares. The residuals from this model show a strong interaction between the proportion of the area logged and antecedent wetness. Area logged includes clearcut areas and a portion of each streamside buffer zone corresponding to the proportion of the timber removed (Henry, table 2, these proceedings). Antecedent wetness was derived by accumulating and then decaying, using a 30-day half-life, the mean daily discharges measured at the South Fork weir. The relation of the residual from the peaks model with area logged is linear, with the positive slope decreasing with increasing antecedent wetness (fig. 5a). The relation with the logarithm of wetness is linear, with the negative slope increasing in magnitude with increasing logged area (fig. 5b). These relations imply that a product term is an appropriate expression of the interaction, and the coefficient is expected to be negative. The fact that the average residual increases with different categories of area logged, but not with wetness, suggests that a solo logged area term is needed in the model as well as the interaction product, but a solo antecedent wetness term is not. No variables related to roads, skid trails, landings, firelines, burning, or herbicide application

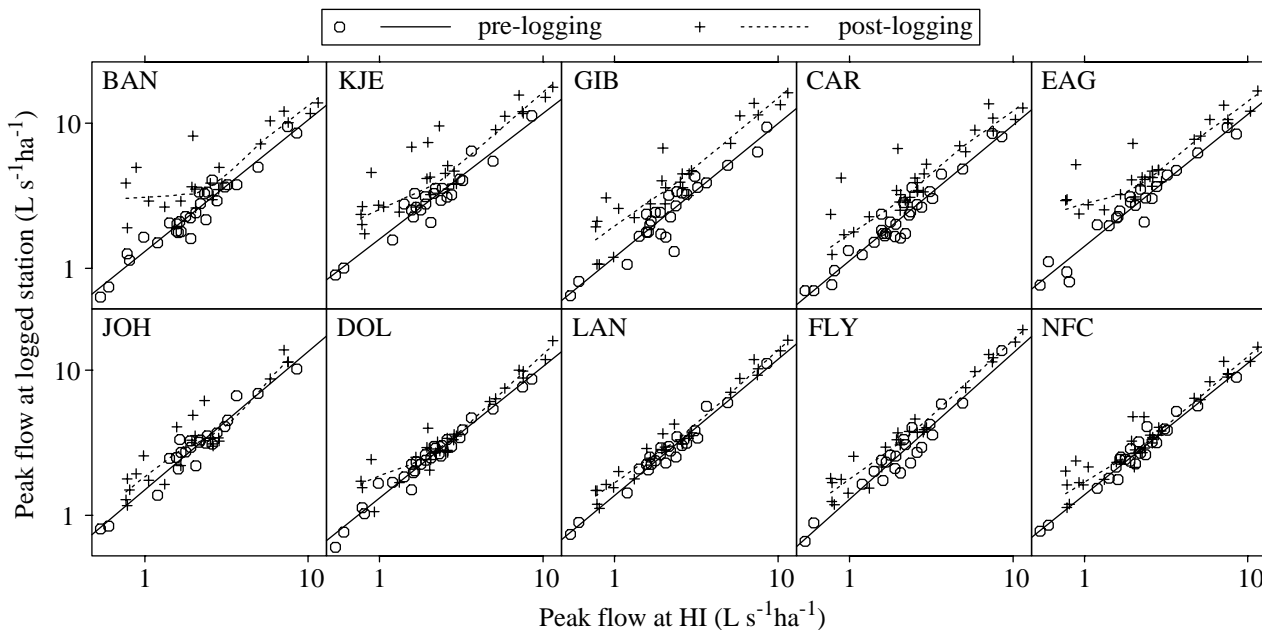

Figure 3 — Relation between peak streamflow in the 10 treated tributaries in the North Fork of Caspar Creek, using the mean of untreated tributaries HEN and IVE (HI) as a control. Pre-logging years began in WY 1986. Post-logging years began in 1990, 1991, or 1992 depending on watershed (see Henry, table 1, these proceedings).

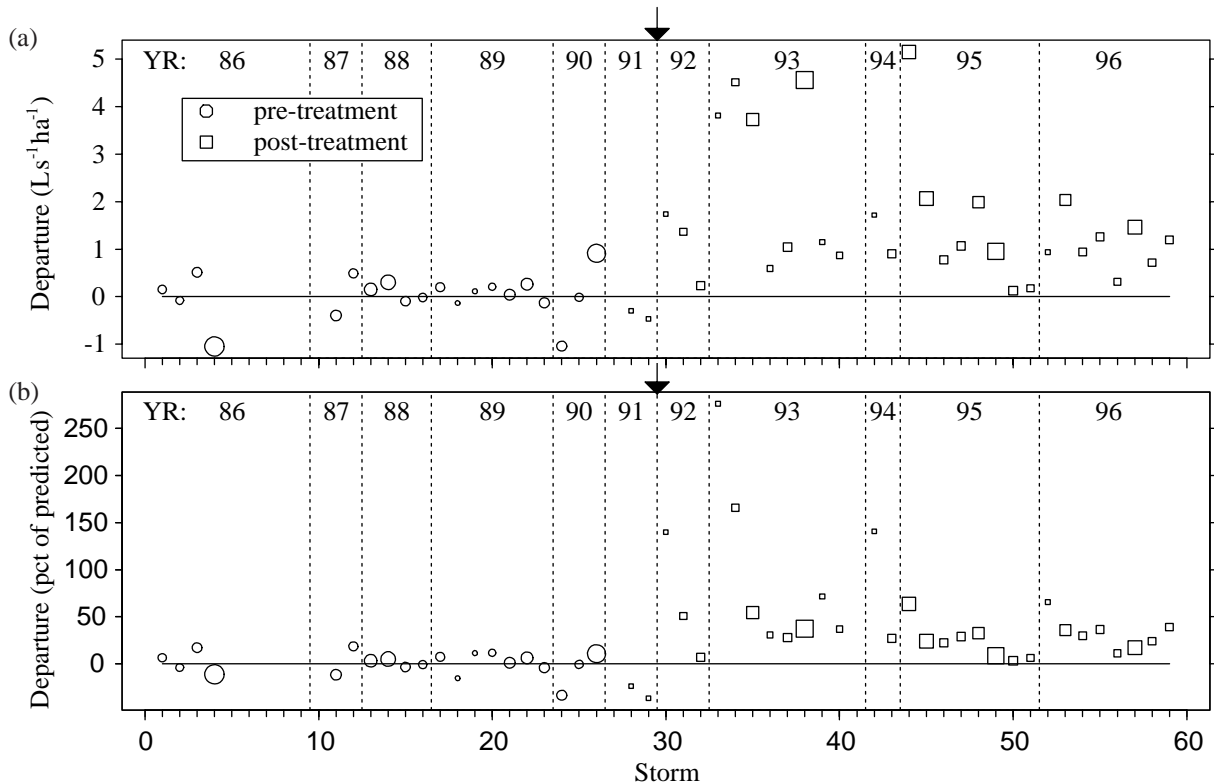

Figure 4 — Absolute (a) and percent (b) departures from the predicted peak for watershed EAG plotted against storm number. The largest departures occurred early in the season. Arrows indicate end of first summer after logging began. Areas of symbols are proportional to the size of the peak at HI.

were found to improve the fit of the linear least squares model that includes logged area and its interaction with antecedent wetness. After adding logged area and the wetness interaction to the model, a plot of post-treatment residuals against time after logging indicates an approximately linear recovery rate of about 8 percent per year in the first 7 years after logging (*fig. 6*).

There was no trend of the relationship between unit area storm peak and watershed area. When the peaks model was fit to the data, the coefficient of a variable designed to express cumulative effects did not differ significantly from zero ($p = 0.21$). There was a weak suggestion ($p = 0.047$) that the effect of logged area on peak flows tended to diminish in larger storms.

The residuals conformed remarkably well to the normal distribution, as did plots for individual stations. The model fitted the data very well (observed versus fitted). For the regression between observed and fitted values, $r^2 = 0.9460$. This compares with $r^2 = 0.8481$ for a model with no disturbance variables and $r^2 = 0.9367$ for the model fit to only the pre-treatment data, so the complete model fits better than expected.

Pipeflow peaks. In addition to the 15 stream gaging stations, two zero-order swales, each having a drainage area of about 1 ha (Preface, *fig. 2*, these proceedings) were instrumented to measure subsurface pipeflow (Ziemer and Albright 1987, Ziemer 1992).

Pipeflow accounted for nearly all of the storm flow from these swales. There was no surface channel flow and no near-surface flow through the colluvial wedge.

Elevated pore water pressures (Keppeler and Brown, these proceedings, Keppeler and others 1994) produced by inefficient subsurface water drainage are a primary cause of large mass erosion events (Cafferata and Spittler, these proceedings). Where subsurface piping networks exist, as in Caspar Creek, matrix interflow can be captured and efficiently routed to surface downslope channels. However, large hydrostatic forces can develop rapidly and cause slope failure if the pipe network is discontinuous or a constriction or collapse retards water flow within the pipe (Tsukamoto and others 1982).

After two winters of data collection in the two swales, all of the trees in one swale (K2) were felled and removed by cable yarding in August 1989. The other swale (M1) was kept as an uncut control. After logging, peak pipeflow increased in swale K2 to about 3.7 times greater than that expected in an unlogged condition, based on the peak pipeflow observed in the uncut control swale (Ziemer 1992). However, all but two of the pipeflow discharge measurements after logging were from moderate storms (less than 300 L min^{-1}).

If pipeflow during large storms also increases after logging, there may be important consequences for slope stability and gully

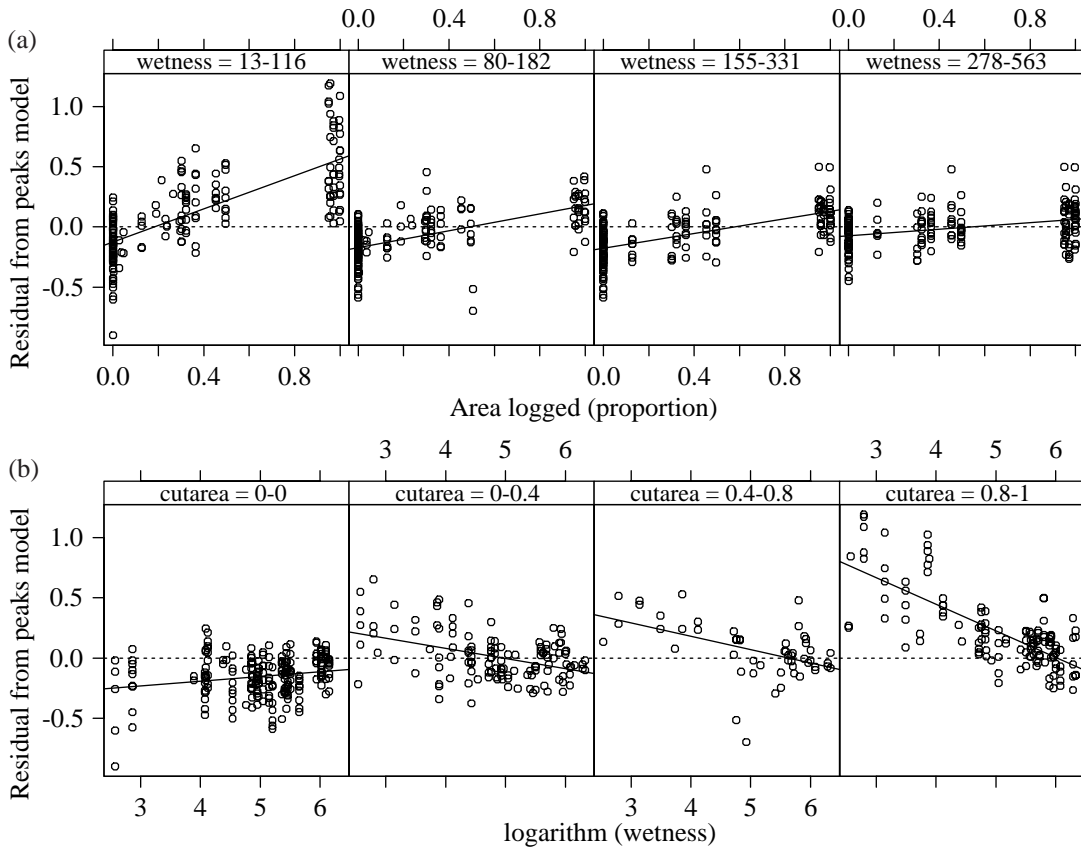

Figure 5 — (a) Relation of residuals from the peaks model (with no disturbance variables) with area logged, for different levels of watershed wetness, and (b) relation of residuals from the peaks model with watershed wetness, for different levels of area logged.

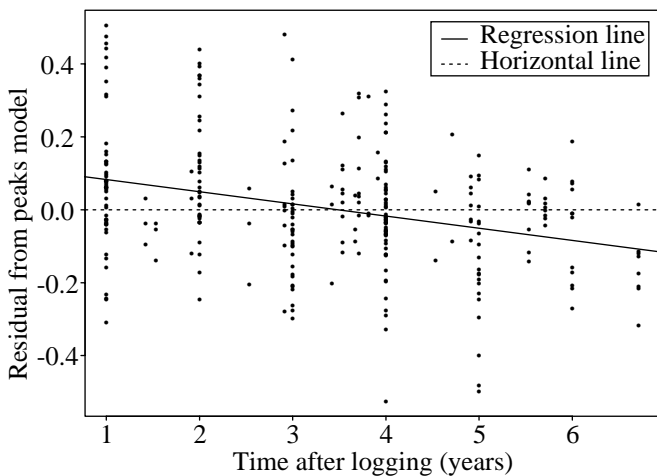

Figure 6 — Relation of post-treatment residuals with time after logging, after logged area and watershed wetness have been included in the peaks model.

initiation. In contrast to open channel conditions, soil pipe discharges are limited by the physical capacity of the pipe. The diameter of pipe K201 is about 50 cm at its outlet while that of M106 is about 70 cm (Albright 1991). Consequently, the capacity of the K201 soil pipe appears to limit discharge above about 500 L min⁻¹, while M106 can freely pass discharges of at least 1700 L min⁻¹ (Keppeler and Brown, these proceedings). If pipeflow during the largest storms has increased after logging, but this additional flow cannot freely pass through the pipe because of limited capacity, then large hydrostatic forces can develop rapidly and increase the potential for slope failure and gully initiation.

Storm Runoff Volume

In addition to evaluating storm peak discharge following logging, the total volume of streamflow for the duration of each storm was analyzed. The storm volume analysis included 527 observations representing 59 storms. As in the peaks analysis, an aggregated

regression model was fit simultaneously to the storm runoff volumes from all of the subwatersheds (Lewis and others 1998). HI (the mean of HEN and IVE) was chosen as the control. The results were very similar to those from the peaks analysis discussed earlier.

The maximum increase in storm runoff volume based on aggregated regression model was 400 percent, but the runoff volume of most storms increased by less than 100 percent. The mean percentage increase in storm volume declined with wetness but was still positive even under the wettest conditions of the study, when it was 27 percent for clearcuts and 16 percent in partially cut watersheds. Increases more than 100 percent generally occurred only in clearcuts under relatively dry conditions and when runoff volume in the control watersheds was less than $250 \text{ m}^3\text{ha}^{-1}$. Large increases in storm volume occurred less frequently as the winters progressed, but increases more than 100 percent did occur in January and February. The mean percentage increase in storm runoff volume declined with storm size and then leveled off at an average increase of 30 percent in clearcuts and 13 percent in partially cut watersheds for storm runoff greater than $250 \text{ m}^3\text{ha}^{-1}$.

Annual storm runoff volume (sum of storms) increased an average of 60 percent ($1133 \text{ m}^3\text{ha}^{-1}$) in clearcut watersheds and 23 percent ($435 \text{ m}^3\text{ha}^{-1}$) in partly clearcut watersheds. Based on the complete discharge record at the North Fork weir, the runoff volume for the storms included in this analysis represents about 45 percent of the total annual runoff volume in individual tributaries.

Discussion

When discussing land-use effects on floods, it is important to be conscious about the difference between an analysis of hydrograph peaks and an analysis of floods. When the public thinks of a “flood,” the image is likely a rare and unusual event that inundates and causes damage to roads, homes, businesses, or agriculture. Floods generally refer to major discrete events that overflow the banks of rivers and streams. These floods are events that occur perhaps once a decade. However, a stream discharge that is expected each year or once every couple of years is usually considered by most observers to be representative of a “normal” high flow event, not a “flood.” The human infrastructure is usually constructed to cope with such “normal” events. Further, a rise in stream discharge during the five to 10 rainstorms that occur commonly each winter results in hydrograph peaks, but these would not be considered to be floods.

To evaluate changes in hydrologic response associated with land use, a sufficient number of streamflow events must be observed to obtain the statistical power needed to determine significance. Within a 50-year record, it would be extremely fortunate to measure a 25-year streamflow event before land treatment to compare with a 25-year event after treatment. Even with this great fortune, there would be little that an analyst could say statistically about the events. Only about five 10-year events would be expected during that 50-year record, and those events probably would be scattered throughout the record, before, during, and after treatment. Consequently, to increase statistical power, the analyst is forced to increase the number of observations by including progressively smaller events into the category of large flow. Often, this results in

the category of “large peaks” no longer meeting the common definition of a “flood.”

Results from watershed studies in the Pacific Northwest are variable. Rothacher (1971, 1973) found no appreciable increase in peak flows for the largest floods attributable to clearcutting. Paired-watershed studies in the Cascades (Harr and others 1979), Oregon Coast Range (Harr and others 1975), and at Caspar Creek (Wright and others 1990, Ziemer 1981) similarly suggested that logging did not significantly increase the size of large peak flows that occurred when the ground was saturated.

Using longer streamflow records of 34 to 55 years, Jones and Grant (1996) evaluated changes in peak flow from timber harvest and road building from a set of three small basins (0.6 to 1 km^2) and three pairs of large basins (60 to 600 km^2) in the Oregon Cascades. In the small basins, they reported that changes in small peak flows were greater than changes in large flows. In their category of “large” peaks (recurrence interval greater than 0.4 years), flows were significantly increased in one of the two treated small basins, but the 10 *largest* flows were apparently unaffected by treatment. Jones and Grant (1996) reported that forest harvesting increased peak discharges by as much as 100 percent in the large basins over the past 50 years, but they did not discuss whether the 10 largest peak flows in the large basins were significantly affected by land management activities. A subsequent analysis of the same data used by Jones and Grant concluded that a relationship could not be found between forest harvesting and peak discharge in the large basins (Beschta and others 1997).

Throughout much of the Pacific Northwest, a large soil moisture deficit develops during the dry summer. With the onset of the rainy season in the fall, the dry soil profile begins to be recharged with moisture. In the H.J. Andrews Experimental Forest in the Oregon Cascades, the first storms of the fall produced streamflow peaks from a 96-ha clearcut watershed that ranged from 40 percent to 200 percent larger than those predicted from the pre-logging relationship (Rothacher 1971, 1973). In the Alsea watershed near the Oregon coast, Harris (1977) found no significant change in the mean peak flow after clear-cutting a 71-ha watershed or patch cutting 25 percent of an adjacent 303-ha watershed. However, when Harr (1976) added an additional 30 smaller early winter runoff events to the data, average fall peak flow was increased 122 percent. In Caspar Creek, Ziemer (1981) reported that selection cutting and tractor yarding of an 85-year-old second-growth redwood and Douglas-fir forest increased the first streamflow peaks in the fall about 300 percent after logging. The effect of logging on peak flow was best predicted by the percent of area logged divided by the sequential storm number, beginning with the first storm in the fall. These first rains and consequent streamflow in the fall are usually small and geomorphically inconsequential in the Pacific Northwest. The large peak flows, which tend to modify stream channels and transport most of the sediment, usually occur during mid-winter after the soil moisture deficits have been satisfied in both the logged and unlogged watersheds. These larger events were not significantly affected by logging in the H.J. Andrews (Rothacher 1973), Alsea (Harris 1977, Harr 1976), or Caspar Creek studies.

There are several explanations why relationships between land

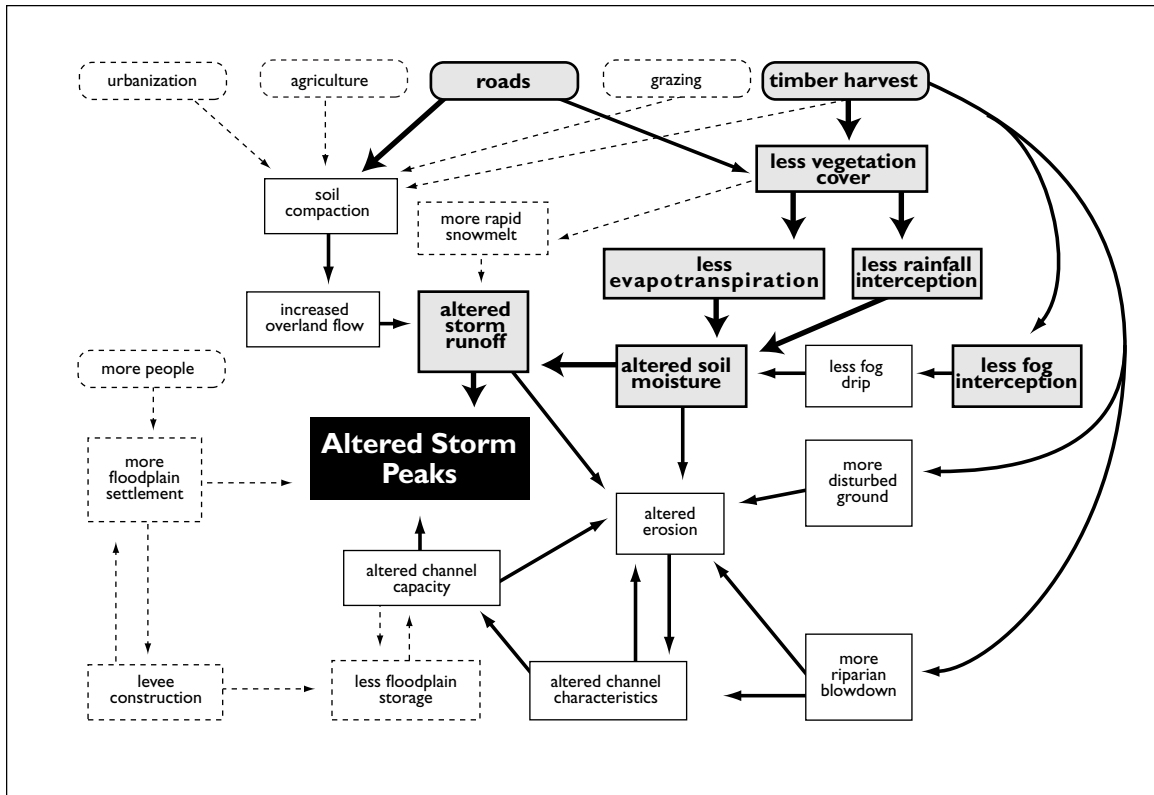

Figure 7 — A process model of the relation between land use and altered storm peaks. The components and linkages thought to be most important at Caspar Creek are bold, those not applicable to Caspar Creek are dotted.

management activities and a change in storm peaks have been difficult to document. First, the land management activity may actually have no effect on the size of storm peaks. Second, if there is an effect, it may be difficult to detect without a large number of observations because the variability of the observations is large relative to the change. Hirsch and others (1990), for example, reported that annual floods often have a coefficient of variation (ratio of standard deviation to mean) of one or more. This means that if the frequency distribution changed abruptly halfway through a 40-year annual flood record, the change in the mean would have to be at least 45 percent to be discernible with 95 percent power. However, land-use changes in the watershed are often gradual rather than abrupt, making detection of a change even more difficult. Third, the range of observations may not adequately cover the range of interest. As discussed earlier, there is a low chance of observing many major storms in any record.

No change in peak streamflow was detected at the North Fork weir after logging when the South Fork was used as the control (*fig. 2*), but an increase in peaks was detected when the uncut tributaries were used as the controls (*fig. 3*). This apparent discrepancy has several possible explanations:

- 1) The pre-treatment relationship between the North Fork and the South Fork is more variable (RMSE = 0.232)

than that between the North Fork and the control tributaries (RMSE = 0.118). Using the tributary controls allows detection of a smaller magnitude of change.

- 2) The range of the South Fork pre-treatment data included larger storms ($20 \text{ L s}^{-1}\text{ha}^{-1}$), whereas the largest storm observed in the control tributaries did not exceed $11 \text{ L s}^{-1}\text{ha}^{-1}$. Using the South Fork as the control, thereby including larger storms, increases the variability, but it also improves the relevance of the analysis concerning larger storms.

Process Model of Storm Peaks

Based on the small-watershed studies at Caspar Creek and elsewhere, a schematic hypothesis of the relationship between land use and storm peaks can be constructed (*fig. 7*). Typical land uses in small watersheds in the Pacific Northwest are urbanization, agriculture, roads, grazing, and timber harvest. Each land use influences storm peaks somewhat differently. Urbanization, grazing, and agriculture are not present in the North Fork of Caspar Creek. Roads, landings, and skid-trails in the North Fork are all located near the ridges and well away from any streams. Further, soil compaction from roads and timber harvest represent only 3.2 percent of the North Fork watershed and range from 1.9 percent to

8.5 percent for the tributary watersheds. Consequently, roads, soil compaction, and overland flow did not produce important changes in peak flow response of the North Fork watersheds. Snow is extremely rare and is not an important component of the hydrology of Caspar Creek.

The data from the streamflow, pipeflow, and soil moisture studies at Caspar Creek all suggest that the peak flow response to logging is related to a reduction in vegetative cover. Reducing vegetative cover, in turn, reduces evapotranspiration, rainfall interception, and fog interception. Since little soil moisture recharge occurs during the spring and summer growing season, large differences in soil moisture can develop between logged and unlogged watersheds by late summer because of differences in evapotranspiration. For example, by late summer, a single mature pine tree in the northern Sierra Nevada depleted soil moisture to a depth of about 6 m and to a distance of 12 m from the trunk (Ziemer 1968). This single tree transpired about 88 m³ more water than the surrounding logged area. This summer evapotranspiration use by one tree is equivalent to about 180 mm of rainfall over the affected area. At Caspar Creek, the largest changes in peak streamflow after logging were found to be for the first storms after lengthy dry periods (Ziemer 1981). Similarly, after logging the North Fork, there was a strong interaction between the proportion of the area logged and watershed wetness that explained differences in streamflow peaks.

Reduced vegetative cover also results in less rainfall interception. Rainfall interception can result in a substantial reduction in the amount of rainfall that reaches the ground. Although we have not measured rainfall interception at Caspar Creek, studies elsewhere have documented that a large portion of annual rainfall is intercepted and evaporated from the forest canopy. For example, Rothacher (1963) reported that under dense Douglas-fir stands in the Oregon Cascades, canopy interception loss averaged 24 percent of gross summer precipitation and 14 percent gross winter precipitation. Interception losses are greatest during low-intensity rainfall interspersed with periods of no rain. As with evapotranspiration, rainfall interception can contribute to important differences in antecedent conditions between logged and unlogged watersheds. During the large high-intensity storms that result in large streamflow peaks, rainfall interception is probably less important. However, differences in interception between logged and unlogged areas probably explain most of the observed increases in the larger peaks.

Similarly, reduced vegetative cover can result in less interception of fog. Much of north coastal California has persistent summer fog, and Caspar Creek is no exception. Fog interception affects watershed hydrology in several ways. First, fog reduces evapotranspiration by raising humidity and by wetting transpiring leaf surfaces. Second, in some areas, fog drip from the tree canopy can add water to the soil, resulting in more streamflow than might occur from rain alone. When the forest is removed, the fog-drip contribution is lost. For example, Harr (1980) reported that after 25 percent of two small watersheds were patch clearcut in the Bull Run

Municipal Watershed near Portland, Oregon, annual water yields and the size of peak flows were not changed, but summer low flows *decreased* significantly. In a followup study, Harr (1982) reported that fog drip accounted for 200 mm, or about a third of all precipitation received from May through September. At Caspar Creek, the presence of fog certainly reduces the rate of evapotranspiration. However, although the amount has not been measured directly, there is abundant circumstantial information to suggest that fog *drip* at Caspar Creek is not an important contributor to either soil moisture (Keppeler and others 1994, Keppeler, these proceedings) or to streamflow (Keppeler, these proceedings, Ziemer 1992, Ziemer and others 1996) — and certainly not to peak stormflows (Ziemer 1981).

The Bottom Line

The effect of logging second-growth forests on streamflow peaks in Caspar Creek is consistent with the results from studies conducted over the past several decades throughout the Pacific Northwest. That is, the greatest effect of logging on streamflow peaks is to increase the size of the smallest peaks occurring during the driest antecedent conditions, with that effect declining as storm size and watershed wetness increases. Further, peaks in the smallest drainages tend to have greater response to logging than in larger watersheds. The reason for this is both physical and social. Stormflow response of small basins is governed primarily by hillslope processes, which are sensitive to forest practices, whereas stormflow response of large basins is governed primarily by the geomorphology of the channel network (Robinson and others 1995), which is less likely to be affected by forest practices. From the social standpoint, Forest Practice Rules and economics tend to limit the amount of intense activity occurring within any given watershed in any year. Therefore, it is possible for entire small first-order watersheds to be logged within a single year. However, as the size of the watershed increases, a smaller proportion of the watershed is likely to have been logged in any given year. In the largest watersheds, harvesting may be spread over decades, within which time the earliest harvested areas will have revegetated.

The effect of logging on stormflow response in Caspar Creek seems to be relatively benign. The resulting changes in streamflow do not appear to have substantially modified the morphology of the channel (Lisle and Napolitano, these proceedings) or the frequency of landsliding (Cafferata and Spittler, these proceedings). However, increased stormflow volume after logging was the most significant variable explaining differences in suspended sediment load (Lewis, these proceedings). Further, logging has increased soil moisture and summer lowflow (Keppeler, these proceedings), subsurface and soil pipe flow (Keppeler and Brown, these proceedings), woody debris (Reid and Hilton, these proceedings), and modified other riparian conditions. The ecological significance of these changes remains to be determined.

References

- Albright, Jeffrey S. 1992. **Storm runoff comparisons of subsurface pipe and stream channel discharge in a small, forested watershed in northern California.** Arcata, CA: Humboldt State University; 118 p. M.S. thesis.
- Beschta, R.L.; Pyles, M.R.; Skaugset, A.E.; Surfleet, C.G. 1997. **Peak flow responses to clear-cutting and roads in small and large basins, western Cascades, Oregon: an alternative analysis.** Unpublished report supplied by author. Department of Forest Engineering, Oregon State University, Corvallis, Oregon.
- Chittenden, H.M. 1909. **Forests and reservoirs in their relation to streamflows, with particular reference to navigable rivers.** American Society of Engineering Transactions 62: 248-318.
- Chow, G.C. 1960. **A test of equality between sets of observations in two linear regressions.** *Econometrica* 28: 591-605.
- Cleveland, William S. 1993. **Visualizing data.** Summit, NJ: Hobart Press; 360 p.
- Harr, R. Dennis. 1976. **Forest practices and streamflow in western Oregon.** Gen. Tech. Rep. PNW-49. Portland, OR: Pacific Northwest Forest and Range Experiment Station, Forest Service, U.S. Department of Agriculture; 18 p.
- Harr, R. Dennis. 1980. **Streamflow after patch logging in small drainages within the Bull Run Municipal Watershed, Oregon.** Res. Paper PNW-268. Portland, OR: Pacific Northwest Forest and Range Experiment Station, Forest Service, U.S. Department of Agriculture; 16 p.
- Harr, R. Dennis. 1982. **Fog drip in the Bull Run Municipal Watershed, Oregon.** *Water Resources Bulletin* 18(5): 785-789.
- Harr, R. Dennis; Harper, Warren C.; Krygier, James T.; Hsieh, Frederic S. 1975. **Changes in storm hydrographs after road building and clear-cutting in the Oregon Coast Range.** *Water Resources Research* 11: 436-444.
- Harr, R. Dennis; Fredriksen, Richard L.; Rothacher, Jack. 1979. **Changes in streamflow following timber harvest in southwestern Oregon.** Res. Paper PNW-249. Portland, OR: Pacific Northwest Forest and Range Experiment Station, Forest Service, U.S. Department of Agriculture; 22 p.
- Harris, D.D. 1977. **Hydrologic changes after logging in two small Oregon coastal watersheds.** Water Supply Paper 2037. Washington, DC: Geological Survey, U.S. Department of the Interior; 31 p.
- Hewlett, John D. 1982. **Forests and floods in the light of recent investigation.** In: Associate Committee on Hydrology, National Research Council of Canada, Canadian hydrology symposium: 82; 1982 June 14-15; Fredericton, New Brunswick, Canada. Ottawa, Canada: National Research Council of Canada; 543-559.
- Hirsch, R.M.; Walker, J.F.; Day, J.C.; Kallio, R. 1990. **The influence of man on hydrologic systems.** In: Wolman, M.G.; Riggs, H.C., eds. *The geology of North America*, vol. O-1, Surface water hydrology. Boulder, CO: Geological Society of America; 329-359.
- Hoover, M.D. 1945. **Effect of removal of forest vegetation upon water-yields.** *American Geophysical Union Transactions Part 6* (1944): 969-977.
- Jones, J.A.; Grant, G.E. 1996. **Peak flow responses to clear-cutting and roads in small and large basins, western Cascades, Oregon.** *Water Resources Research* 32: 959-974.
- Keppeler, Elizabeth T.; Ziemer, Robert R.; Cafferata, P.H. 1994. **Changes in soil moisture and pore pressure after harvesting a forested hillslope in northern California.** In: Marston, R.A.; Hasfurther, V.R., eds. *Effects of human-induced changes on hydrologic systems*; 1994 June 26-29; Jackson Hole, WY. Herndon, VA: American Water Resources Association; 205-214.
- Lewis, J.; Keppeler, E.T.; Mori, S.R.; Ziemer, R.R. 1998. **Cumulative impacts of clearcut logging on storm peak flows, flow volumes and suspended sediment loads.** Unpublished draft supplied by author.
- Lull, Howard W.; Reinhart, Kenneth G. 1972. **Forests and floods in the eastern United States.** Res. Paper NE-226. Upper Darby, PA: Northeastern Forest Experiment Station, Forest Service, U.S. Department of Agriculture; 94 p.
- Robinson, J.S.; Sivapalan, M.; Snell, J.D. 1995. **On the relative roles of hillslope processes, channel routing, and network geomorphology in the hydrologic response of natural catchments.** *Water Resources Research* 31: 3089-3101.
- Rothacher, Jack. 1963. **Net precipitation under a Douglas-fir forest.** *Forest Science* 4: 423-429.
- Rothacher, Jack. 1971. **Regimes of streamflow and their modification by logging.** In: Krygier, J.T.; Hall, J.D., eds. *Proceedings of the symposium on forest land use and stream environment*; Corvallis, OR. Corvallis, OR: Oregon State University, 55-63.
- Rothacher, Jack. 1973. **Does harvest in west slope Douglas-fir increase peak flow in small streams?** Res. Paper PNW-163. Portland, OR: Pacific Northwest Forest and Range Experiment Station, Forest Service, U.S. Department of Agriculture; 13 p.
- Tsukamoto, Y.; Ohta, T.; Noguchi, H. 1982. **Hydrological and geomorphological studies of debris slides on forested hillslopes in Japan.** In: Walling, D.E., ed. *Recent developments in the explanation and prediction of erosion and sediment yield: proceedings of the Exeter Symposium*; 1982 July 19-30; Exeter, UK. International Association of Hydrological Sciences Publication No. 137. Wallingford, UK: IAHS; 89-97.
- Wright, Kenneth A.; Sendek, Karen H.; Rice, Raymond M.; Thomas, Robert B. 1990. **Logging effects on streamflow: storm runoff at Caspar Creek in northwestern California.** *Water Resources Research* 26: 1657-1667.
- Ziemer, Robert R. 1968. **Soil moisture depletion patterns around scattered trees.** Res. Note PSW-166. Berkeley, CA: Pacific Southwest Forest and Range Experiment Station, Forest Service, U.S. Department of Agriculture; 13 p.
- Ziemer, Robert R. 1981. **Storm flow response to road building and partial cutting in small streams of northern California.** *Water Resources Research* 17: 907-917.
- Ziemer, R.R. 1992. **Effect of logging on subsurface pipeflow and erosion: coastal northern California, USA.** In: Walling, D.E.; Davies, T.R.; Hasholt, B., eds. *Erosion, debris flows and environment in mountain regions*, Proceedings of the Chendu symposium; 1992 July 5-9; Chendu, China. International Association of Hydrological Sciences Publication No. 209. Wallingford, UK: IAHS; 187-197.
- Ziemer, R. 1998. **Caspar Creek hydrologic and climatic data: 1963-1997.** CD-ROM, 545 MB. 1998 May. Arcata, CA: Pacific Southwest Research Station, USDA Forest Service, and Fort Bragg, CA: California Department of Forestry and Fire Protection.
- Ziemer, Robert R.; Albright, Jeffrey S. 1987. **Subsurface pipeflow dynamics of north-coastal California swale systems.** In: Beschta, R.L.; Blinn, T.; Grant, G.E.; Swanson, F.J.; Ice, G.G., eds. *Erosion and sedimentation in the Pacific Rim*, Proceedings of the Corvallis Symposium, 1987 August 3-7. International Association of Hydrological Sciences Publication No. 165. Wallingford, UK: IAHS; 71-80.
- Ziemer, Robert R.; Lewis, Jack; Keppeler, Elizabeth T. 1996. **Hydrologic consequences of logging second-growth watersheds.** In: LeBlanc, John, ed. *Conference on coast redwood forest ecology and management*; 1996 June 18-20; Arcata, CA. Berkeley, CA: University of California; 131-133.

Subsurface Drainage Processes and Management Impacts¹

Elizabeth Keppeler² and David Brown³

Abstract: Storm-induced streamflow in forested upland watersheds is linked to rainfall by transient, variably saturated flow through several different flow paths. In the absence of exposed bedrock, shallow flow-restrictive layers, or compacted soil surfaces, virtually all of the infiltrated rainfall reaches the stream as subsurface flow. Subsurface runoff can occur within micropores (voids between soil grains), various types of macropores (structural voids between aggregates, plant and animal-induced biopores), and through fractures in weathered and consolidated bedrock. In addition to generating flow through the subsurface, transient rain events can also cause large increases in fluid pressures within a hillslope. If pore pressures exceed stability limits of soils and shallow geologic materials, landslides and debris flows may result. Subsurface monitoring of pipeflows and pore pressures in unchanneled swales at North Fork Caspar Creek in the Jackson Demonstration State Forest began in 1985. Four sites have been established to investigate the effects of timber harvest (K1 and K2) and road building (E-road) for comparison with an unmanaged control drainage (M1). Flow through large soil pipes at these sites is highly transient in response to storm events, reaching peak discharges on the order of 100 to 1,000 L min⁻¹. Pore pressures at these sites also respond dynamically to transient rain events, but to date have not exceeded slope stability limits. Most soil pipes cease flowing in the dry summer period and hillslope soil moisture declines to far below saturation. The clearcut logging and skyline-cable yarding of the K2 site resulted in dramatic increases in soil pipeflow and subsurface pore pressures. During the first 4 years after timber harvest, pore pressures increased 9 to 35 percent for the mean peak storm event in the control M1 site. Peak soil pipeflow response was far greater, increasing 400 percent in the 4-year postlogging period. These results suggest that the soil pipes are a critical component of subsurface hillslope drainage, acting to moderate the pore pressure response. As the subsoil matrix becomes saturated and pore pressures build, soil pipes efficiently capture excess water and route it to the stream channel. This logging does not appear to have impaired the hillslope drainage function. Methods and results at the E-road site are quite different. Here, the mid-swale road construction and tractor yarding have resulted in large changes in the pore pressure response. Positive pore pressures were negligible in the upper portion of this instrumented swale before disturbance. Subsequent to the road construction in May 1990, there was little indication of immediate impacts. But, after the completion of felling and tractor yarding in late summer 1991, dramatic changes in pore pressure response were observed beginning in hydrologic year 1993 and continuing to date (1998). Largest pore pressure increases have occurred at sensor locations in and up-slope of the road prism. Below the road, the response is muted. These data support previous studies documenting the profound effects of roading and tractor logging on watersheds and provide special insight into these effects for this region.

The hydrologic response of forested watersheds to rain events occurs through several interrelated flow processes. Soil surface conditions determine whether rainfall will run off as surface flow or whether it will infiltrate and travel through the subsurface. Infiltration capacities for soils in the coastal redwood region exceed maximum rainfall intensities common in the region. Exceptions occur in isolated areas where bedrock is exposed at the land surface. More widespread are infiltration limitations resulting from soil compaction associated with road building, landings, and other constructed surfaces. Over the great majority of forested landscapes, rainfall infiltrates into the soil and flows through the subsurface to streams, rivers, and lakes.

Subsurface flow may occur within soil horizons, regolith (weathered bedrock), or bedrock (*fig. 1*). The conductive and storage properties of a given earth material as well as the spatial relations of adjoining materials strongly influence the actual flow path through the subsurface. For example, water may flow within soil horizons through the matrix, a porous medium of individual grains. Pores on the individual grain scale transmit water very slowly, several orders of magnitude less than surface water flows. Larger pores (on the order of 1 mm in diameter or larger) are commonly referred to as macropores, and can conduct substantial quantities of water at rates approaching surface flow velocities. By virtue of their geometry, macropores can be shown to conduct water more rapidly under high moisture conditions than the “micropores” of the soil matrix. Macropore geometry and type varies with depth below the land surface arising from various biologic and soil-forming processes (*fig. 1*). Interconnected large macropores (on the order of 2 cm in diameter or larger) are often referred to as “soil pipes.” These features are erosion pathways that extend within the shallow subsurface horizons as continuous or interconnected conduits forming complex branching networks (Albright 1992). An important hydrologic attribute of macropores is that the surrounding soils must be saturated before water can flow into these large pores. Thus, the antecedent moisture conditions in forest soils strongly control the importance of flow through macropores; and hence, the hydrologic response of a watershed to a precipitation event. Similarly, fractures in regolith or bedrock may dominate the flow response under saturated conditions, and thus define a significant flow path distinct from the soil matrix or macropores.

The movement of water into and through these flow paths has two consequences of both theoretical interest and practical application to the management of forestlands. First, surface runoff in streams is generated on two widely different time scales: (1) on a seasonal basis and (2) during individual precipitation events. Runoff volume, timing, and duration affect both water supply and flood propagation. Seasonal effects of subsurface flows are manifest in the storage properties of forest soils. During the summer, water

¹ An abbreviated version of this paper was presented at the Conference on Coastal Watersheds: The Caspar Creek Story, May 6, 1998, Ukiah, California

² Hydrologist, Redwood Sciences Laboratory, Pacific Southwest Research Station, USDA Forest Service, 802 N. Main St., Fort Bragg, CA 95437 (ekeppeler@rsl.psw.fs.fed.us)

³ Assistant Professor, Department of Geosciences, California State University, Chico, CA 95929 (dbrown@shasta.csuchico.edu)

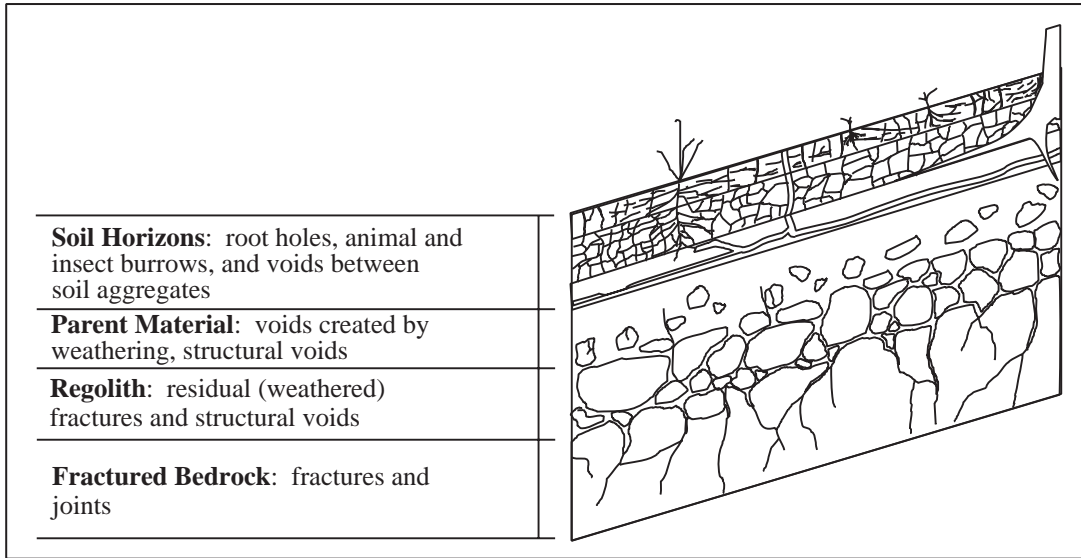

Figure 1—Hypothetical soil cross-section with characteristic voids and flow path variations.

drains from soils and supports perennial streamflow (baseflow). This drainage creates a water deficit in the soil that must be replenished before maximum flow through a hillslope can occur.

The second consequence of transient subsurface flow is directly related to the storm-driven evolution of pore pressures at the hillslope scale. Gravity is the primary force driving the flow of water in upland forested watersheds. However, if soil compaction closes pore spaces and prevents or reduces drainage through macropores, water pressure may increase such that the strength of the hillslope is lost and shallow landslides or debris flows may occur. Mass failures are a significant source of sediment reaching streams and are generated from background earth surface processes and from human activities such as road building. Dynamic interactions between pore pressures, drainage geometry, and the material properties of soil and bedrock can significantly influence the stability of slopes and channel heads, as well as sediment releases to streams (Dietrich and others 1986).

Research investigations at Caspar Creek have explored these hillslope and subsurface drainage processes with the dual objectives of identifying impacts associated with logging and road building and reducing the risk of mass failures associated with timber harvest activities in the redwood region.

Methods

Headwater swales were selected for monitoring in both a control (MUN) and two designated treatment sub-basins (KJE and EAG) of the North Fork experimental watershed (Preface, fig. 2, these proceedings). All study sites are moderately steep zero-order basins located in the North Fork watershed at an approximate elevation of 300 m (fig. 2). An almost 100-year-old second-growth forest occupied these sites at the initiation of these investigations (Henry, these proceedings). All study swales are drained by one or more soil pipes with outflow in evidence at the base of the swale axis. Pipeflow

varies seasonally from less than 0.01 L min⁻¹ to more than 1,000 L min⁻¹ at individual soil pipes. Most soil pipes are intermittent or seasonally dry.

The vegetation community is a coniferous forest type with a

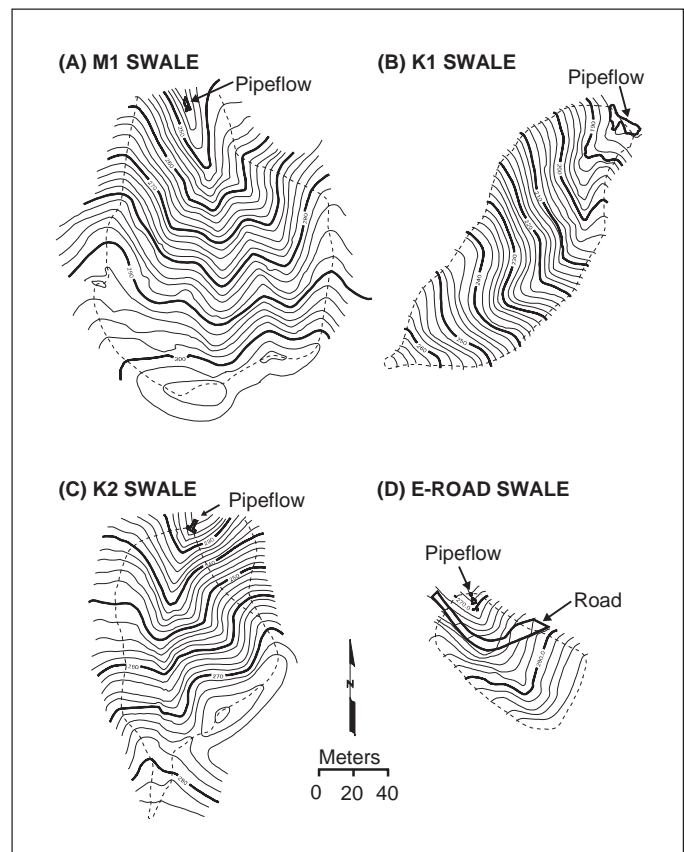

Figure 2—North Fork Caspar Creek study swales (2-m contour interval).

closed canopy consisting of coastal redwood (*Sequoia sempervirens* (D. Don) Endl.) and Douglas-fir (*Pseudotsuga menziesii* (Mirb.) Franco) as the dominant tree species. Although not measured during this study, the diameter-at-breast height is estimated to range from approximately 0.3 m to 1.5 m. Forests in the Caspar Creek watersheds were clearcut and burned in the late 1800's (Tilley and Rice 1977; Napolitano, these proceedings), and are generally typical second-growth forests. Other tree species occurring at this site include grand fir (*Abies grandis* (Dougl. ex D. Don) Lindl.), western hemlock (*Tsuga heterophylla* (Raf.) Sarg.), and tanoak (*Lithocarpus densiflorus* (Hook. and Arn.) Rohn).

The soil at these sites has been classified as a clayey, mixed isomesic Typic Tropudult described as the Van Damme series (Huff and others 1985). Surface soils tend to have a loamy texture and increasing clay content with depth (Wosika 1981). Discontinuous argillic horizons have been observed in scattered soil pits (Dahlgren 1998). Soil thicknesses range from 1.0 m along the ridges to 1.5 m in the swales (Wosika 1981). The parent material below this depth range is a highly weathered layer of fractured regolith derived from the underlying graywacke sandstone of Cretaceous age known as the Franciscan Assemblage (Huff and others 1985). Geologically recent tectonic forces (1 my b.p.) acting along the San Andreas fault system just offshore have contributed to a gradual uplift of up to 200 m (Jenny 1980). Field estimates of hydraulic conductivities were made using slug tests in piezometers in EAG, KJE, and MUN swales. Saturated hydraulic conductivity estimates for the regolith above the hard bedrock contact range on the order of 10^{-8} to 10^{-4} m s⁻¹.

Local climate is heavily influenced by the site's proximity to the coast (approximately 10 km to the west). Like most of coastal California, the large majority of the rainfall occurs during late fall and winter months. The mean annual rainfall for this area is 1190 mm (46.85 in). Relatively little rainfall occurs between the months of April and October, but coastal fog may supply moisture to the soils via fog drip. Air temperatures range from a January mean of 7 °C to a high of about 15 °C in July.

M1 Site

The M1 site is the designated control site and thus retains continuous second-growth forest cover. This 1.7-ha swale (fig. 2a) is the largest subsurface study site. The terrain slope varies from 20 to 50 percent. One large and several small soil pipes drain the swale. These soil pipes were fitted for instrumentation in 1986 (Ziemer and Albright 1987). The large 80 cm (height) by 60 cm (width) pipe, M106, has discharged the highest pipeflow peak recorded in the North Fork watershed—1,700 L min⁻¹ on January 20, 1993. This pipe occurs at the interface between the upper soil and an argillic horizon (Albright 1992). Two transects of piezometers, denoted A (three instruments) and C (four instruments), were installed to bedrock (at depths of up to approximately 6.0 m) on the side slopes above the piping gage station (Brown 1995). A nest of piezometers was installed at the confluence of the two subswales. Two piezometer nests were installed at the confluence of the subswales (piezometers B1 and B2) and just upslope of the swale at the bottom of the C transect (piezometers C1 and C2). Two additional

piezometers were installed to bedrock, one in each of the two upper tributary swales (Brown 1995). On the basis of the soil borings excavated during piezometer installations, a geologic cross-section was prepared across the A-C transects (fig. 3). Soil horizons and regolith thicknesses were fairly uniform throughout both slopes.

K1 Site

A second pipeflow site, K1, was developed near the KJE stream gaging station in 1986 (Preface, fig. 2, these proceedings). This 1.0-ha swale (fig. 2b) is drained by several soil pipes within the upper 0.5 m of the soil with diameters ranging from 10 to 20 cm (Albright 1992). Most are flashy and ephemeral, yielding significant flows only during storm events. Pipeflow, surface flow, and matrix flow at the soil face were gaged at this second site, but no subsurface pore pressure measurements were made. The site was clearcut and skyline yarded from the ridge in 1989 as part of the Caspar East timber sale unit K (Henry, these proceedings). No slash burning or other site preparation was done in this unit after timber harvest.

K2 Site

This 0.8-ha zero-order swale (fig. 2c) was first instrumented for pipeflow measurements in 1986. Three soil pipes were gaged at this site. The largest soil pipe, K201, is 50 cm in diameter and emerges from the exposed soil face at a depth of less than 1.5 m from the ground surface (Albright 1992). In 1987, a network of piezometers and tensiometers was established along five hillslope transects (Keppeler and others 1994) that were aligned perpendicular to a west-facing K2 hillslope. To prevent excessive disturbance of this steep 70 percent slope, a system of ladders and catwalks was built before instrument installation. Hillslope installations include: 31 bedrock piezometers, 27 1.5-m-deep piezometers, and 25 tensiometers at depths of 30, 45, 60, 120, and 150 cm. Three of these instrument transects (A, B, C) are about 20 m in length and extend from near the swale axis to mid-slope positions. The other

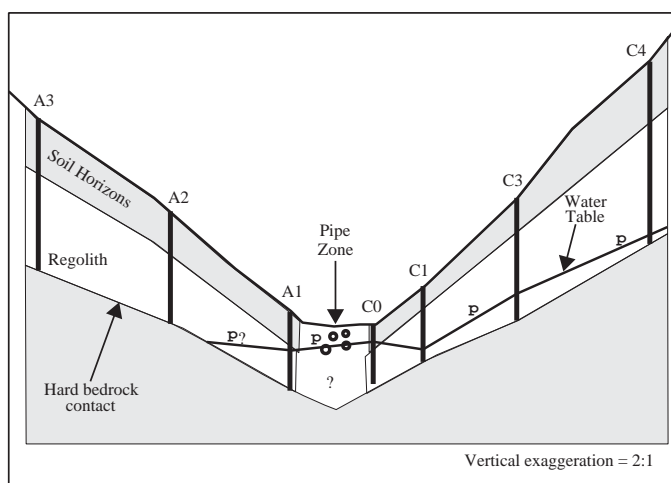

Figure 3—Cross-section of soils, geology, soil pipe, and piezometer installations at the M1 site.

two transects (D and E) extend nearly to the ridge. Two additional bedrock piezometers are installed in the swale axis. After two winters of data collection, the K2 site was clearcut and skyline yarded from the ridge during August 1989 (Henry, these proceedings). No slash burning or other site preparation was done in this unit following timber harvest.

E-Road Site

The smallest and most recent Caspar Creek subsurface monitoring site is the E-road swale. This 0.4-ha swale is located in the EAG sub-basin and cutblock E of the North Fork (Preface, fig. 2, these proceedings). This north-facing swale is drained by two instrumented soil pipes. A single 44-m-long transect consisting of six bedrock and two shallower piezometer installations extends through the swale axis from the soil pipe excavation to a position 38 m from the ridge (fig. 2d). Piezometer depths range from < 1.5 m at the lower end of this transect to almost 8 m at the top. The terrain slope along this transect averages 35 percent. This site was instrumented in fall 1989 to evaluate the impacts of road construction on hillslope drainage processes. Predisturbance monitoring of pore pressures and pipeflow occurred during the winter 1990. In June 1990, a seasonal road was built across this swale to a yarder landing on the unit divide. The road centerline crosses the instrument transect at the R4P2 piezometer. The grade of this 30-m road segment averages 19 percent. The fill depth is 3 m at its maximum, 2 m at the centerline, 1.6 m at R3P2, and <1 m at R2P2 (near the base of the roadfill). This haul road was rocked for use during October and November of 1990 when a portion of the Unit E cutblock was harvested using a cable skyline yarder at the end of this spur. In late-summer 1991, the timber not cut during the road right-of-way felling was harvested using tractor yarding above and long-lining below the road. Broadcast burning of the unit occurred in late November. Because of the north-facing aspect of this swale, fuel consumption was incomplete.

Instrumentation

Field investigations were undertaken first to identify the most upslope occurrence of gulying or sinkholes associated with pipeflow outlets at each study swale. At these existing collapses, handcrews excavated a near-vertical soil face to facilitate the capture of pipeflow and soil matrix discharge. Soil pipes ranging in diameter from 2 to 60 cm and occurring within 2 m of the soil profile were instrumented. Flow from individual sources (pipes, overland flow, and soil matrix flow) was captured by first driving metal flashing collectors into the excavated soil profile, then connecting these collectors to PVC (polyvinyl chloride) pipe, and finally routing the flow into an upright PVC standpipe container. Drainage holes were drilled into these standpipe containers and a laboratory calibration was done to establish the relationship between stage in the container and discharge. Containers were designed with a variety of drain hole diameters and placements to accommodate a wide range of discharges. Using electronic pressure transducers and data loggers, container stages were recorded at 10-min intervals during the winter season and at 30-min intervals during the lowflow season. Frequent manual discharge measurements were made at these

pipeflow sites to verify and refine the standpipe container calibrations (Ziemer and Albright 1987).

To measure the pore pressure response along selected transects in these study swales, piezometer wells were installed by hand-augering 10-cm-diameter holes through the soil profile. A PVC pipe (38 or 51 mm diameter) was then cut to extend from the base of the hole to several centimeters above the ground surface. The lower 15-cm length of this pipe was slotted with a hack saw. Plastic mesh screen was wrapped around the slotted portion of the pipe before the pipe was placed in the augered hole. The hole was backfilled first with pea gravel for about 25 cm of the depth, then 15 to 20 cm of bentonite, and finally, with natural soil. Hillslope instruments were assigned a transect identifier and numbered beginning with the base of the slope and progressing up the hill. P2 indicates a "bedrock" piezometer, and P1 indicates a shallower installation.

Bedrock installations were augered to the physical limit of the hand auger device. At some sites, rock fragments in the lower saprolite prevented the auger from reaching competent bedrock. Shallower piezometers were installed at certain sites where a low-permeability clay layer (argillic horizon) was encountered. Finally, a few piezometers were installed into competent bedrock using a rock drill. Water levels (pore pressures) were monitored using a combination of techniques. Manual measurements were made at all piezometers at least weekly using an electronic water surface detector. Electronic pressure transducers connected to a data logger sensed piezometer water levels at 15-min intervals during the winter and less frequently during the lowflow periods at the K2 and E-road swales (Keppeler and Cafferata 1991, Keppeler and others 1994). Accuracy of these measurements was generally within a 0.05-m tolerance. At the M1 site, a comparable transducer/data-logger combination provided water level heights with a design accuracy of approximately 0.01 m along three transects (A, B, and C). Only very rarely did the electronic data differ from hand measurements by more than 0.02 m. Pressure heads in the piezometers were logged at 15-min intervals during storm periods, and at 2-hr intervals between storms.

Soil tensiometers were installed at some sites to provide a measure of soil moisture in unsaturated conditions and to indicate when the shallower soil horizons became seasonally saturated. These devices are commonly used for assessing agricultural irrigation needs. Our tensiometers consist of a porous ceramic cup connected to a closed tube and a vacuum gage. The cup is buried in the soil and the tube is filled with water. As the soil moisture tension equilibrates with the water tension in the tube, a vacuum is created and indicated on the gage. At field capacity, this tension is 33 cb. As the soil drains, tensions exceeding 85 cb may be recorded. These gages were read manually at weekly intervals and, in some cases, connected to a data logger via a pressure transducer allowing for frequent readings and recordings. Keppeler (these proceedings) reports summer soil moisture changes at these sites.

Analyses

Ziemer (1992) evaluated changes in peak pipeflow after the logging of the K1 and K2 swales using data from hydrologic year 1987 through 1991. Regression analysis was used to develop a relationship between individual soil pipes at the K1 and K2 sites

and the M1 site control, as well as total pipe discharge per site. A second set of regressions was developed using the postlogging pipeflow peaks. Chow's test (Chow 1960) was used to detect differences between these regression lines ($p < 0.05$). For this report, additional peak pipeflow data through hydrologic year 1993 from the K201 and M106 sources were analyzed using this regression approach. This analysis included 38 prelogging and 41 postlogging storm peak pairs from K201 and M106.

Keppeler and others (1994) evaluated the piezometric response to logging in the K2 site. Regression analysis was used to define the prelogging relationship between peak pore pressures along selected K2 transects and peak discharge (\log_{10}) at the M106 soil pipe. Postlogging regressions were then developed for storm peaks occurring during hydrologic years 1990-1993. Zar's test for comparing regression lines (Zar 1974) was used to detect differences between the calibration and postlogging relationships ($p < 0.05$). A similar procedure was applied to evaluate piezometric pressure heads during nonstorm periods.

Initial analysis of the pore pressure response to road building was done nonstatistically by comparing E-road piezometric peaks and ranges before and after road construction and tractor logging. In addition, further analysis was attempted using E-road piezometer peaks regressed on peak discharge (\log_{10}) at the M106 soil pipe. Only preliminary screening of other factors relating to the E-road subsurface response has been performed.

Results and Discussion

Pipeflow

Increased peak pipeflow was detected at the fully clearcut K2 site during the first winter after logging (1990), but larger increases were observed one year later (Ziemer 1992). During 1990 and 1991, peak pipeflow at K2 (pipe K201) was 370 percent greater than predicted by the calibration relationship with M1 (pipe M106). Extending this analysis to include peak discharges through 1993 provides further insight into the pipeflow response to logging. With 38 peaks ranging up to 525 L min⁻¹ (M106) in the prelogging data set, a linear regression provides a very good fit to the data ($r^2 = 0.96$) as evident in *figure 4b*. The postlogging data set contains 41 peaks, with all but two of the M106 peak discharges less than 300 L min⁻¹. Those two large peaks exceed the prelogging data by a substantial margin (*fig. 4a*), and present an interesting complication to evaluating treatment effects. The largest storm produced a peak at M106 of 1700 L min⁻¹ on January 20, 1993, triple the size of the largest M106 peak in the prelogging data set. The return interval for this peak is approximately 8 years based on the 35-yr North Fork peakflow record. The postlogging relationship between M106 and K201 is much more variable than the prelogging relationship. Although pipe K201 yields maximum discharges of up to 500 L min⁻¹, it appears to be capable of unrestricted discharge only until about 250 L min⁻¹. The recurrence interval of the comparable North Fork streamflow peak is approximately 0.3 years. K201 discharge appears to be restricted by pipe capacity above a discharge of about 250 L min⁻¹, whereas M106 can pass discharges of at least 1,700 L min⁻¹. The other instrumented soil pipes also exhibit peak discharge

restrictions at even lower discharges. In contrast to open channel conditions, pipeflow is limited by the physical capacity of the pipe. The cross-sectional area of pipe K201 is much less than M106; thus, discharge capacity at K201 is more limited than M106. Field observations indicate that upslope of the M1, K2, and K1 gaging sites; several ungaged pipe outlets produce significant discharge volumes during larger storm peaks. These "overflow" features provide further evidence of the hydraulic limitations of these main soil pipe pathways.

a) K201 (logged 1989) versus M106 (unlogged control)

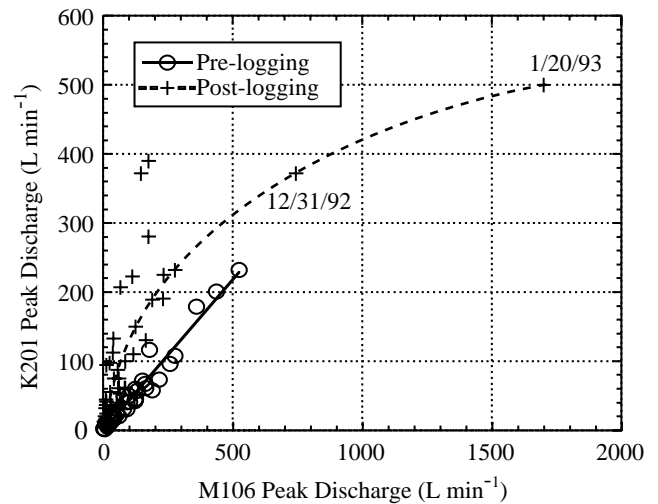

b) M106 Discharge < 300 L min⁻¹

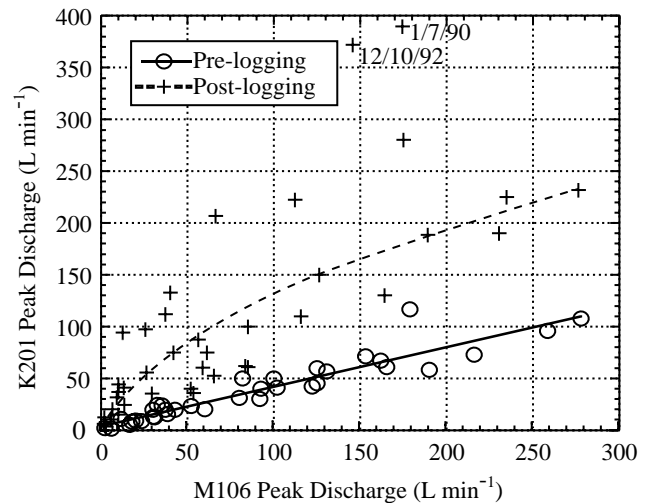

Figure 4—A comparison of the peak pipeflow response from M106 (unlogged control) and K201 (clearcut in 1989) and regression lines. The solid line is the linear fit to the prelogging data. The dashed line is the locally fitted regression of the postlogging data and is approximated by a second-order polynomial fit to a log-log relationship. Plot (a) includes all data. Plot (b) excludes the larger M106 peaks where K201 begins to exhibit capacity limitations.

Because of these physical limitations, a linear regression analysis of the postlogging K201 and M106 peakflow data is not appropriate for moderate to high peak discharges. However, it is clear that a substantial increase in K201 pipeflow occurred after logging (*fig. 4*). When the postlogging data are fit by a locally weighted regression (Cleveland 1993), it is evident that the greatest departures from pretreatment data occur at discharges of less than 200 L min^{-1} at M106. Above this level, K201 peaks begin to level off. When the M106 discharges exceed 500 L min^{-1} , it is not possible to detect any postlogging change in K201 discharge peaks. The prelogging regression equation predicts that at the mean M106 peak pipeflow of 118 L min^{-1} the expected K201 peak is 51 L min^{-1} , but the postlogging locally weighted regression predicts a peak of 143 L min^{-1} — a 280 percent increase (*fig. 4b*).

The maximum postlogging increase at K201 was more than 300 L min^{-1} for two moderate storm events that occurred January 7, 1990 and December 10, 1992 (*fig. 4b*). These storms produced discharges at North Fork Caspar with return intervals of 1.7 times per year. The largest proportionate increases in pipe peakflow occurred during two minor storms in February 1991, when winter rainfall totals had been far below normal. These were the first stormflow responses at M1 for that year indicating that antecedent soil moisture conditions were just reaching saturation, whereas K2 soils were more fully saturated. As previously explained, the soil in the vicinity of the pipe pathway must be saturated before water can flow through these conduits. Ziemer's evaluation of Caspar Creek streamflow peaks (these proceedings) states that the largest increases in peak discharges occur when the greatest differences in soil moisture exist between the logged and forested watersheds.

At K1, peakflow from instrumented soil pipes did not show a significant increase (Ziemer 1992). However, an additional pipe outlet

located about 30 m upslope of the pipeflow gaging instrumentation began to discharge storm flows. This source flowed rarely before logging, but regularly during storm events after logging, suggesting that the capacity of the K1 soil pipes was quite limited in comparison to either K201 or M106. When the discharge from this source is added to that of the other instrumented K1 pipes, the K1 peakflow increase approximates the increase observed at K201 (Ziemer 1992).

Keppeler (these proceedings) reports increases in minimum summer pipeflow, as well. The duration of these postlogging increases has yet to be documented.

M1 Pore Pressures

The water table throughout the entire monitoring period was observed only along the regolith-hard bedrock interface. A typical water table profile across the A-C transects during late February 1994 is shown in *figure 3*. On the basis of field observations of the soil pipes emerging at the pipeflow gages, it appears that the pipes in the swale bottom occur at depths where the water table often fluctuates into and around the pipe zone. As the winter progressed, the piezometers responded more rapidly to larger rain events. This behavior supports the findings of Ziemer and Albright (1987) who observed a strong dependence of pipeflow on soil moisture conditions. Piezometric responses in undisturbed drainages will generally mirror pipeflow responses because both are dependent on flow through macropores. Soil pipes are simply the largest size-class of macropores. The peak piezometric response was noted for a mid-February 1994 storm with peak rainfall occurring over an 18-hr period (*fig. 5*). Piezometric responses on the two side-slope transects were fairly similar to each other. The lag between the rainfall and the peak piezometric response for A and C transects

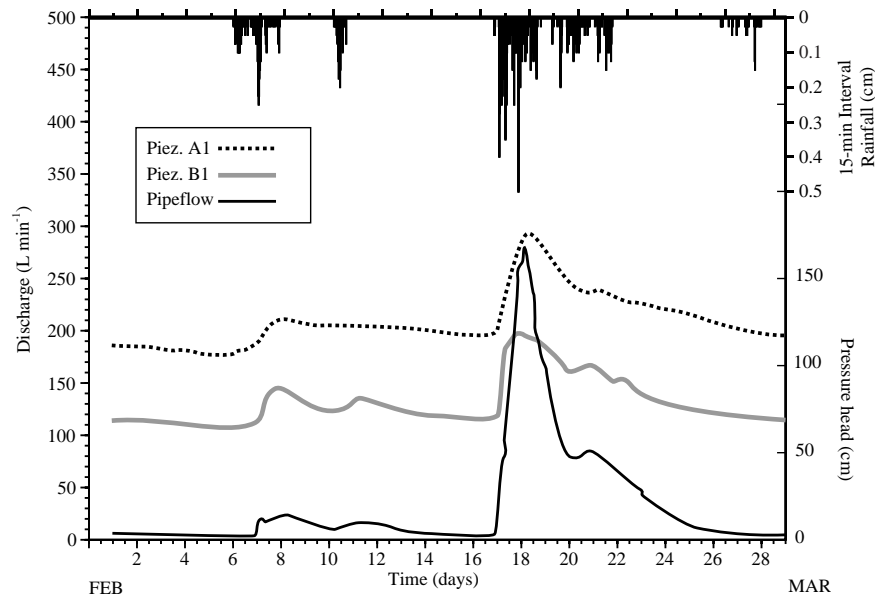

Figure 5—M1 pipeflow and piezometric response to a moderate storm event during February 1994. Note the similarity between pipe discharge and subsurface pore pressures responses to this discrete storm event.

generally exceeded the lag for the B-nest piezometers. The convergence of flow in the B subswoles could explain the difference in lag times with the parallel side-slopes.

K2 Pore Pressures

The post-treatment response along two transects (C and E) has been evaluated through hydrologic year 1993. Regression analysis results indicate increased peak piezometric responses after logging. All six postlogging regressions were significantly different than the prelogging regressions ($p < 0.05$). The postlogging intercept terms were greater than the prelogging coefficients and, in some cases, the slopes of the postharvest regression lines were reduced (fig. 6). Unlike the stream discharge peaks (Ziemer, these proceedings) and the pipeflow peak response just described, increases in peak pore pressures were detectable for both large and small storms, as well as for antecedent moisture conditions ranging from a relatively dry to a fully saturated soil profile. Between storms, piezometric water levels remained higher in the postharvest period than before harvest. Sidle and Tsuboyama (1992) state that pore pressure responses tend to be less variable at the base of the hillslope than at upslope positions because of higher soil moisture content and the presence of preferential pathways in the saturated zone. These K2 data support that hypothesis. Greater variation and larger magnitude increases were observed in the upslope piezometers (C3P2 and the E transect). At the mean M106 peak discharge, pore pressures were 9 to 35 percent greater than those predicted by the preharvest relationship.

E-Road Pore Pressures

With only a single year of pretreatment data, regression analysis

was only marginally successful in illuminating changes in pore pressure response at the E-road site. Before road construction, pore pressure responses at this site were minimal. Although the bore holes for the two most upslope piezometers were the deepest installations at this swale (5.7 and 7.7 m, respectively), positive pore pressures were not detected before road building and tractor logging. During the first winter after road building, these upslope piezometers remained dry; however, some changes were observed at the lower instrument sites (R1P2 and R2P2). There were brief spikes in pore pressures of less than 0.5 m, reflecting individual precipitation events superimposed on a more extended pore pressure response of about half that magnitude indicative of seasonal effects (fig. 7). Hydrologic year 1991 was also the second-driest year on record at Caspar Creek, with annual precipitation totaling only 716 mm. This lack of rainfall made first-year changes difficult to detect.

After tractor logging was completed late in 1991, a series of normal and above-normal rain years ensued. The event-driven pore pressure spikes continued at R1P2 during 1992 and 1993. The regression analyses of the predisturbance pore pressure peaks on the M106 peak pipeflows (\log_{10}) were fairly successful at explaining the variations in response at the downslope installations both before and after logging. The r^2 values for the prelogging regressions were greater than 0.80 for R2P2 and R3P1, and 0.49 for R1P2. Similar r^2 values resulted from the postlogging regressions of these piezometer peaks. The postlogging regressions indicate increased peak pore pressures at R1P2, R2P2, and R3P1 that are similar to those observed at the K2 site (fig. 6). However, there was no significant relationship between peak pipeflow at M106 and the pore pressure response at the upslope E-road piezometers. These results suggest the upslope E-road pore pressure response was quite different than

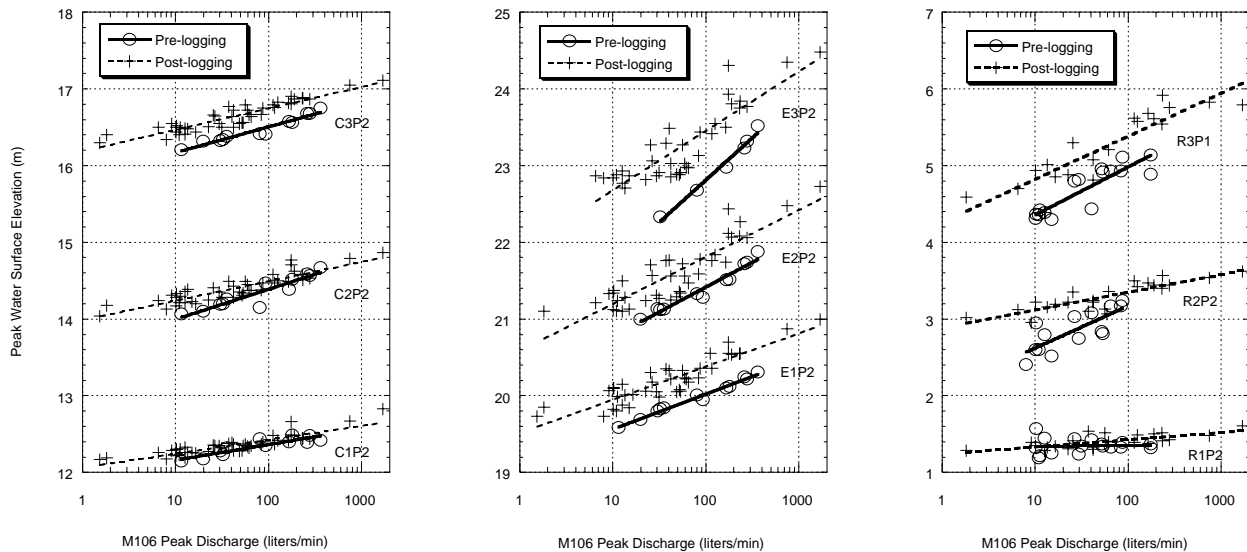

Figure 6—Regression comparisons of peak piezometric response at the K2 and E-road sites before and after clearcutting. C1P2, C2P2, and C3P2 are located in the lower portion of the K2 slope. E1P2, E2P2, and E3P2 are mid-slope K2 locations. R1P2, R2P2, and R3P1 are located along the E-road swale axis between pipeflow outlet and the new road. Elevations are relative to the pipeflow outlet at each swale.

the response below the road and the response in the undisturbed M1 swale.

However, after road construction and logging, a clear and dramatic increase in pore pressure response at the above-road installations is evident. Not only did peak pore pressures increase in response to a discrete storm event, but also there was a progressive increase in piezometric water levels related to cumulative seasonal precipitation (*fig. 8*). At R4P2, the dry-season recession was particularly slow. By late fall of 1994 and 1996, the pore pressure level remained higher than it had been at the onset of the preceding hydrologic year. Pore pressures at this bedrock installation located directly under the road centerline have yet to return to predisturbance levels. At this same location, a second piezometer, installed at the time of road construction at the interface between the fill and the original ground surface, never showed a positive pressure response. However, this pressure transducer failed in 1996 and was not replaced.

For all installations at the E-road site, the post-road construction and logging annual pore pressure peaks exceeded the predisturbance annual peak (*table 1*). To explore this difference, a variable reflecting the storm rank through all years (1990 to 1995) was evaluated. This regression was more significant in explaining the peak responses at R5P2 ($r^2 = 0.23$) and R6P2 ($r^2 = 0.61$), but not significant for the below-road installations. Above the road, the apparent trend in pore pressures levels is one of increased peak levels over time since logging (*fig. 9*). However, this may be a reflection of above-normal rainfall totals in 1993 and 1995, rather than the isolated impact of road construction in this swale. More work remains to be done to model the pore pressure response at this E-road site. Pipeflow data from this site has yet to be evaluated.

This future analysis will provide an important indication of the integrity of the macropore flow mechanism at this site after road construction and tractor logging.

Conclusions

Subsurface flow is the dominant process by which rainfall is delivered to stream channels in the coastal redwood region. Several different flow paths exist within soils and bedrock, and they interact on both rain-event and seasonal time scales. As the soil and subsoil become saturated, the soil pipes play an extremely important role in hillslope drainage. The combined water storage and transmissive properties of shallow earth materials are such that headwater watersheds produce significant storm runoff and dynamic changes in fluid pressures that are an important factor in the stability of hillslopes. Management activities such as timber harvesting and road construction can alter the subsurface flow and pore pressure response to rain events. Increased subsurface flow from the loss of rainfall interception and transpiration after timber harvesting increases peak pipeflow and may accelerate scour erosion within the soil pipes. This form of subsurface erosion can lead to the expansion of discontinuous gullies within the unchanneled swales and increased sediment loading to surface channels such as has been observed in some of the Caspar Creek cutblocks (Ziemer 1992; Lewis, these proceedings). Further, subsurface drainage may be impeded by the felling and yarding of logs in these zero-order swales if matrix and macropore flows are reduced by soil compaction or shallow pipe collapses, thus accelerating gully erosion.

Timber harvesting increases peak pore pressures, but whether these fluid pressures pose significant risks to slope stability is highly

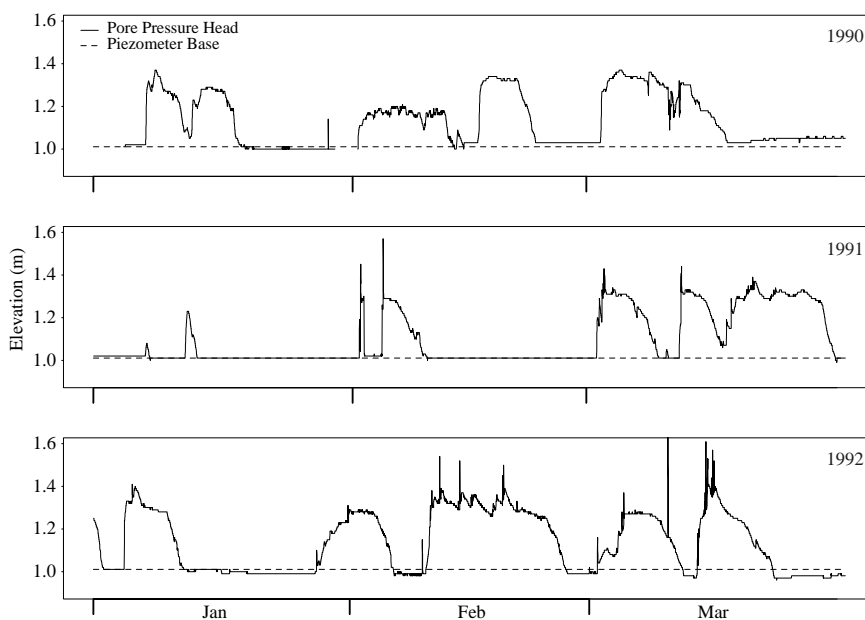

Figure 7—Piezometric response at the E-road site (between the base of the road fill and the pipeflow outlet) for three winter periods: 1990 (predisturbance), 1991 (post-roadbuilding) and 1992 (postlogging). Elevations are relative to the pipeflow outlet.

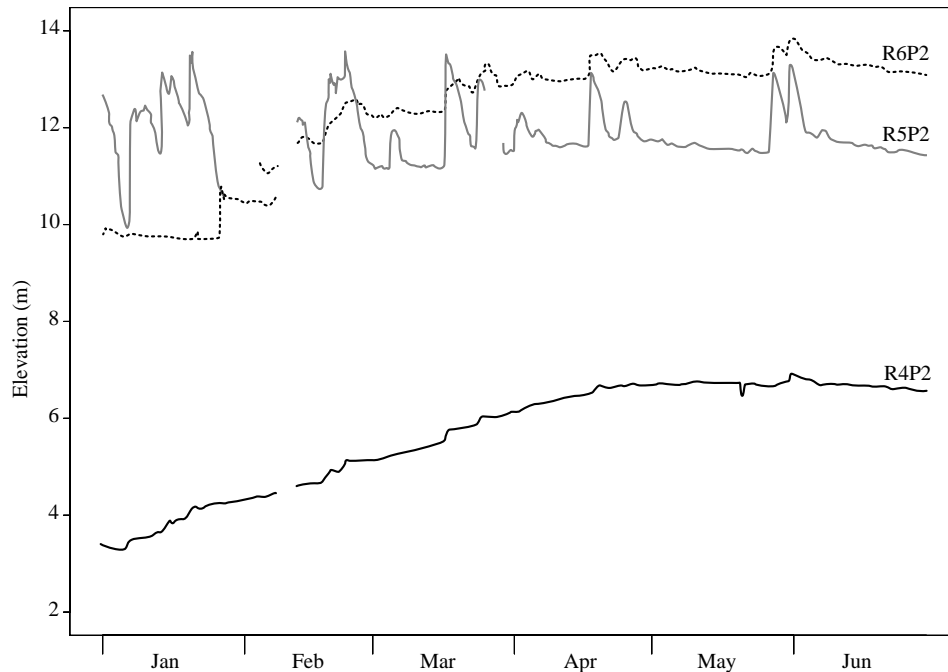

Figure 8—Upslope piezometric response at the E-road site after road construction and tractor logging. Note the seasonal increases in pore pressure heads as the rainy season progresses and the discrete storm response most evident at R5P2. Elevations are relative to the pipeflow outlet. Gaps in traces indicate missing data.

Table 1—Annual maximum pore pressures (m) at E-road piezometers. Road constructed in May 1990 with road centerline at R4P2. Tractor logging of swale occurred September through October 1991. “NR” indicates that no positive pressure head was observed during that year. Base elevation (m) is the bottom of piezometer well relative to the elevation of the pipeflow outlet. Maximum pore pressures for all years are shown in bold.

Hydrologic Year	R1P2	R2P2	R3P1	R3P2	R4P2	R5P2	R6P2
1990	0.37	1.31	0.89	2.11	0.77	NR	NR
1991	0.57	1.71	0.86	3.39	0.63	NR	NR
1992	0.65	1.91	1.37	6.05	6.03	2.97	6.45
1993	0.61	2.09	1.67	4.24	4.61	4.77	4.18
1994	0.42	2.12	1.65	4.29	3.89	3.97	6.56
1995	0.52	1.92	1.84	4.50	5.25	4.72	7.49
1996	0.46	1.88	1.81	4.49	4.69	4.84	6.76
1997	0.45	1.80	1.84	5.59	4.07	4.93	6.04
Maximum Pore Pressure (m)	0.65	2.12	1.84	6.05	6.03	4.93	7.49
Hole Depth (pre-road) (m)	1.37	2.59	1.96	4.80	7.66	5.69	7.83
Base Elevation (m)	1.00	1.53	4.25	1.57	2.29	8.79	9.64

dependent on local hillslope conditions. At those sites most prone to failure because of inherent geologic and soil conditions, timber harvest activities may tip the delicate balance of hillslope stability towards failure. However, such failures are expected only in response to relatively extreme rainfall events occurring at roughly 5-year return periods (Cafferata and Spittler, these proceedings). Thus far, the data from the North Fork phase of the Caspar Creek study suggest that the frequency of large landslides has not increased owing to the timber harvest activities between 1989 and 1991. The road location and design used in the North Fork logging demonstrate a tremendous improvement in the application of the principles of subsurface hydrology to minimize the risks of

aggravating slope instabilities. However, it is too early in the post-harvest history to draw definitive conclusions concerning slope stability. Large landslides occur relatively infrequently; thus, it is necessary to evaluate failure rates over a long time. One caution suggested by the findings in the M1 swale and previous research is that convergent topography will amplify pore pressure responses and there should be special attention and analysis when planning operations in these areas. Designated crossings are an effective safeguard, provided that the designator understands the principles of subsurface hydrology as they relate to erosion control. Road construction can have a very significant impact on the timing and magnitude of pore pressure responses as exemplified by the E-road

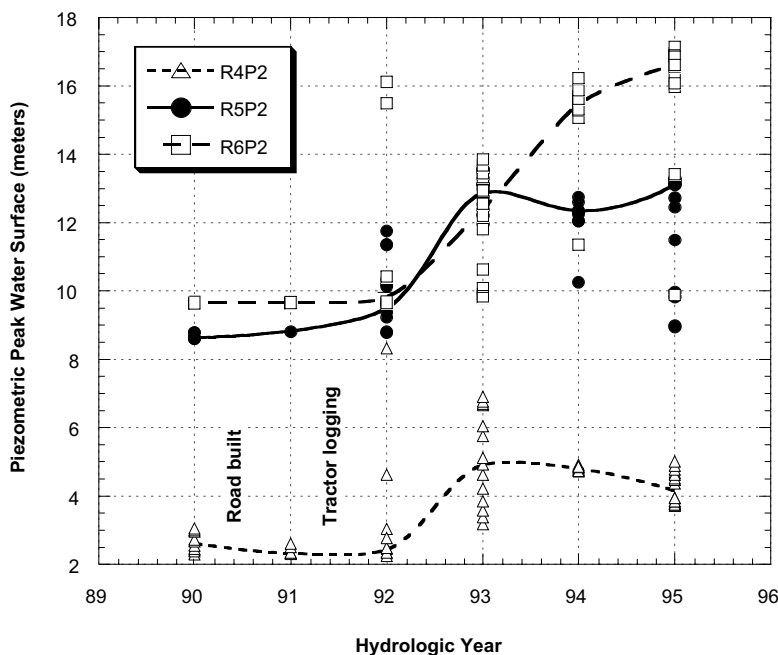

Figure 9—Peak pore pressure response upslope of the new road at the E-road site. Fitted lines connecting median pore pressure peaks suggest a trend of increased pore pressures over the 6-year period since road construction. Elevations are relative to the pipeflow outlet.

site. Additional work is needed to further elucidate more general relationships between road construction and pore pressure evolution, as well as to better understand site-specific subsurface conditions as they affect slope stability.

References

- Albright, Jeffrey S. 1992. **Storm runoff comparisons of subsurface pipe and stream channel discharge in a small, forested watershed in northern California.** Arcata, CA: Humboldt State Univ.; 118 p. M.S. thesis.
- Brown, David Lawrence. 1995. **An analysis of transient flow in upland watersheds: interactions between structure and process.** Berkeley, CA: University of California; 225 p. Ph.D. dissertation.
- Chow, G.C. 1960. **A test of equality between sets of observations in two linear regressions.** *Econometrica* 28: 591-605.
- Cleveland, William S. 1993. **Visualizing data.** Summit, NJ: Hobart Press; 360 p.
- Dahlgren, Randy A. 1998. **Effects of forest harvest on biogeochemical processes in the Caspar Creek Watershed.** Unpubl. Draft Final Rept. prepared for the Calif. Dept. of Forestry and Fire Protection. Agreement No. 8CA17039. Sacramento, CA. 151 p.
- Dietrich, William E.; Wilson, C.J.; Reneau, Steven L. 1986. **Hollows, colluvium, and landslides in soil-mantled landscapes.** In: Abrahams, A.D., ed. *Hillslope processes.* Boston, MA: Allen & Unwin Ltd.; 361-388.
- Huff, T.L.; Smith, D.W.; Powell, W.R. 1985. **Tables for the soil-vegetation map, Jackson State Forest, Mendocino County, Soil-Vegetation Survey.** Sacramento, CA: Calif. Dept. of Forestry, The Resources Agency.
- Jenny, H. 1980. **The soil resource: origin and behavior.** *Ecological Studies* 37. New York, NY: Springer-Verlag.
- Keppeler, E.T.; Cafferata, P.H. 1991. **Hillslope hydrology research at Caspar Creek.** Jackson Demonstration State Forest Newsletter, No. 41, April 1991. 4-8.
- Keppeler, Elizabeth T.; Ziemer, Robert R.; Cafferata, Peter H. 1994. **Changes in soil moisture and pore pressure after harvesting a forested hillslope in northern California.** In: Marston, R.A.; Hasfurther, V.R., eds. *Effects of human-induced changes on hydrologic systems; 1994 June 26-29; Jackson Hole, WY.* Herndon, VA: American Water Resources Association; 205-214.
- Sidle, R.C.; Tsuboyama, Y. 1992. **A comparison of piezometric response in unchanneled hillslope hollows: coastal Alaska and Japan.** *J. Japan Society of Hydrology & Water Resources* 5(3): 3-11.
- Tilley, F.B.; Rice, R.M. 1977. **Caspar Creek watershed study—a current status report.** State Forest Notes No. 66. Sacramento, CA: State of California, Department of Forestry; 15 p.
- Wosika, Edward Pearson. 1981. **Hydrologic properties of one major and two minor soil series of the Coast Ranges of northern California.** Arcata, CA: Humboldt State University; 150 p. M.S. thesis.
- Zar, J.H. 1974. **Biostatistical analysis.** 2d ed. Englewood Cliffs, NJ: Prentice-Hall; 718 p.
- Ziemer, R.R. 1992. **Effect of logging on subsurface pipeflow and erosion: coastal northern California, USA.** In: Walling, D.E.; Davies, T.R.; Hasholt, B., eds. *Erosion, debris flows and environment in mountain regions, proceedings of the Chendu symposium; 1992 July 5-9; Chendu, China.* International Association of Hydrological Sciences Publication No. 209. Wallingford, UK: IAHS; 187-197.
- Ziemer, Robert R.; Albright, Jeffrey S. 1987. **Subsurface pipeflow dynamics of north-coastal California swale systems.** In: Beschta, R.L.; Blinn, T.; Grant, G.E.; Swanson, F.J.; Ice, G.G., eds. *Erosion and sedimentation in the Pacific Rim, proceedings of the Corvallis Symposium, 1987 August 3-7.* International Association of Hydrological Sciences Publication No. 165. Wallingford, UK: IAHS; 71-80.

The Summer Flow and Water Yield Response to Timber Harvest¹

Elizabeth T. Keppeler²

Abstract: Continuous measurement of streamflow at the Caspar Creek watersheds has led to several analyses of the effects of two harvest methods (selection and clearcut) on summer flows and annual yield. Although all Caspar Creek analyses have indicated an increase in runoff after timber removal, the magnitude and duration of the response depend on the nature and extent of the logging and site preparation, climatic conditions, as well as the definition of the hydrologic parameter at issue. Regression analysis using a calibration period of 1963 to 1971 was used to compare annual yield, summer flow volume, and minimum streamflow between the South Fork (SFC) and the North Fork (NFC) of Caspar Creek for a 35-year period. Selection/tractor logging of the SFC increased annual yield by a maximum of 2,053 m³ha⁻¹yr⁻¹ during the seventh water year after harvest began. Increased yields were observed beginning the second post-harvest year and averaged 15 percent or 932 m³ha⁻¹yr⁻¹. Following clearcut logging 50 percent of the NFC watershed, annual yield increased by as much as 1,032 m³ha⁻¹yr⁻¹ 8 years after logging and averaged 15 percent or 608 m³ha⁻¹yr⁻¹ beginning in the second postharvest year. Streamflow changes due to logging are most evident during the long, dry summer season typical of northwestern California. During this prolonged recession, zones of deep perennial saturation maintain streamflow (baseflow). Statistically significant summer flow enhancements were evident on the SFC for 7 years after logging. Subsequently, SFC summer yields fell at or below pretreatment predictions. Although summer flow increases amounted to relatively minor changes in minimum discharge averaging only 0.25 L s⁻¹km⁻² on SFC and 0.40 L s⁻¹km⁻² on NFC, these enhancements are quite substantial in comparison to pretreatment summer low flows. Minimum discharge increases averaged 38 percent after the SFC selection logging and 148 percent after the NFC harvest and site preparation. NFC flow enhancements persist through hydrologic year 1997 with no recovery trend, as yet.

After logging, reduced interception and evapotranspiration allow for additional water to be stored in the soil and routed to streams as summer baseflow. At Caspar Creek, enhanced soil moisture in the rooting zone followed timber harvest in the NFC clearcut units. Previously intermittent stream reaches and soil pipes became perennial. The larger increases in minimum flows observed on the NFC are probably due to wetter soils in the clearcut units where little vegetation exists to use this enhanced moisture. On the selectively cut SFC, mature residual forest vegetation more readily exploited this additional soil moisture. Fog plays an important role in the regional ecology by moderating evapotranspiration. However, Caspar Creek data indicate that any possible postlogging loss of fog drip did not result in a net reduction in streamflow. Moisture savings due to reduced evapotranspiration appear to override any fog precipitation losses at this site.

Forest vegetation has a major influence on the hydrology of a basin. The alteration and removal of forest vegetation continues to be a controversial issue among land managers and public and private interest groups. In the Pacific Northwest, where wet winters are followed by long, dry summers, the effects of timber harvest operations on summer streamflow and soil moisture conditions during the growing season are of significant concern. Rural residents of forested watersheds often rely on springs and small creeks for year-round water supply. Fish and other stream fauna require adequate summer flows to prosper in the limited rearing habitat summer streams provide. Terrestrial species are also quite dependent on riparian areas and perennial streams.

The impacts of timber harvest on water yields and summer flows have been evaluated for several watersheds between northern California and British Columbia. Almost all report enhanced summer flows and annual yields after logging. Reduced evapotranspiration (water use by plants) is the most obvious effect of the removal of forest vegetation. Canopy interception is also reduced, allowing more direct delivery of precipitation to the forest floor. Infiltration and percolation (water movement into and drainage through the soil, respectively) may be impeded by soil disturbance and compaction associated with logging.

The magnitude, timing, and duration of these postlogging increases vary according to several important site factors. Increases in streamflow have been shown to be proportional to the amount of cover removed (Hibbert 1967). Clearcutting yields larger increases than partial cutting (Rothacher 1971). Vigorous growth by the residual understory vegetation or rapid regrowth of the overstory may quickly counter postharvest streamflow enhancements, particularly in wetter regions. The magnitude of the streamflow response to cutting also relates to mean annual precipitation. Wetter regions generally experience the greatest effects.

The dominant explanation of streamflow increases due to logging is that when trees are harvested, transpiration and interception are reduced; thus soils receive more water during the rainy season and retain more moisture through the growing season and thereby sustain higher baseflows. Even when the winter rains return, the wetter soils in the logged area require less precipitation to recharge sufficiently for storm runoff to occur, thus enhancing streamflow relative to unlogged conditions. The greatest relative increases in streamflow are observed in the summer and fall seasons.

An intriguing contradiction to this explanation was observed after logging within the Bull Run Municipal Watershed near Portland, Oregon. Here, a small decrease in annual yield was detected and the number of summer low-flow days actually increased, suggesting reduced summer streamflow (Harr 1982). Harr hypothesized that the reduced summer flow was due to reduced interception of fog precipitation after forest canopy removal. Although summer flow increases were later reported at

¹ An abbreviated version of this paper was presented at the Conference on Coastal Watersheds: The Caspar Creek Story, May 6, 1998, Ukiah, California

² Hydrologist, Redwood Sciences Laboratory, Pacific Southwest Research Station, USDA Forest Service, 802 N. Main St., Fort Bragg, CA 95437 (ekeppeler@rsl.psw.fs.fed.us)

Bull Run about 5 years after harvest (Ingwersen 1985), the initial anomaly observed by Harr (1982) has led to renewed interest in investigating the role of fog precipitation in the Pacific Northwest and how it might be affected by timber harvest operations.

The 35-year record of streamflow at Caspar Creek has made possible an analysis of the effects of timber harvest operations in the south coastal portion of the Pacific Northwest. This report compares the effects of selection cutting and tractor yarding on the South Fork (SFC) streamflow with those of clearcutting and cable yarding on the North Fork (NFC) streamflow. The magnitude and duration of annual yield and summer low flow changes, and variations in summer pipeflow and soil moisture levels are reported.

Methods

Instrumentation

The weirs, constructed in 1962 on the North Fork and South Fork of Caspar Creek, provide the longest continuous record of streamflow for this area. This annual discharge record is complete except for those years when the weir ponds were drained so that the debris basin could be cleaned out (Henry, these proceedings). Additional monitoring of summer flows at the gaging stations on the 13 sub-basins of the North Fork was implemented between 1988 and 1994 (Preface, fig. 2, these proceedings). Except for the mainstem gaging sites, most of these tributary stations were intermittently dry during the summer months although shallow intergravel flow occurred at near-surface depths. To evaluate changes in baseflow, slotted PVC wells were installed in the streambed and equipped with electronic stage sensing devices recording at hourly intervals during summer periods between 1988 and 1994. Although these latter sites have not provided year-round quantifiable discharge data because of resolution and gage design limitations, relative comparisons of summer flows before and after timber harvest are possible.

In addition, soil pipe discharge data collected since 1986 at four sites provides quantifiable data on summer flow contributions from the North Fork headwaters. Soil moisture levels on a hillslope in watershed KJE (Preface, fig. 2, these proceedings) were monitored using 25 tensiometers installed at depths ranging from 30 to 150 cm. Tensiometers are commonly used in agricultural applications to determine irrigation needs. The device consists of a porous cup attached to a plastic tube leading to a vacuum gage. When the soil is unsaturated, a tension is created as the soil attempts to extract moisture through the porous cup to achieve equilibrium. Tension readings (both hourly electronic and manual) from these vacuum gages were made before and after logging at this site.

Annual Yield Analysis

Regression analysis was used to evaluate differences in annual water yield (total yearly streamflow between August 1 and July 31) before and after timber harvest activities on NFC and SFC. Initial evaluation indicated no statistically significant difference in annual yield before and after the 1967 road building on the SFC. Therefore, the calibration regression used data from 1962 to 1971 to define the pretreatment relationship between the two watersheds. To evaluate

the effects of the SFC logging, prediction limits ($p < 0.05$) were calculated to determine whether the postharvest yields from 1972 to 1985 were within the range predicted by the calibration relationship. Similarly, prediction limits were calculated for NFC postharvest yields 1986 to 1997. No attempt has been made to estimate annual yield at the 13 NFC sub-basins or soil pipe sites.

Summer Low Flow Analysis

A similar regression approach was used to analyze changes in minimum summer discharge (mean daily flow) before and after timber harvest activities on NFC and SFC. Minimum discharge dates were selected as late in the low-flow season as possible, generally late August or September, to avoid the effects of small rain events or missing data due to weir maintenance activities. Discharges from both weirs on the same dates were used in this regression.

Data on minimum stage from the NFC subwatershed gages were compared to further evaluate the trends observed at the weirs. One advantage of this comparison was that it allowed the use of data from the undisturbed control tributaries HEN, IVE, and MUN. For each site, the mean annual minimum stage before and after logging was calculated. The “one-tailed” t -test and the non-parametric Mann-Whitney test were used to determine if the postlogging mean was greater than the predisturbance mean ($p < 0.05$).

The hillslope monitoring instrumentation in watersheds KJE and MUN (Keppeler and Brown, these proceedings) provided yet another indicator of logging impacts to the NFC baseflow process. Year-round discharge from soil pipes was monitored before and after

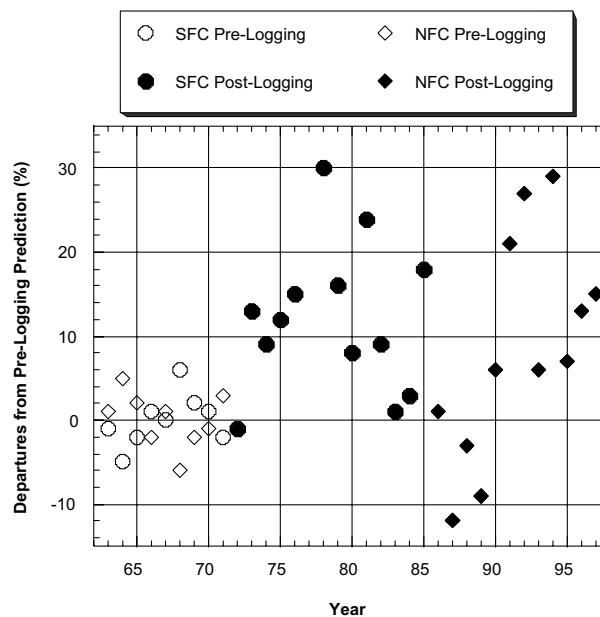

Figure 1—Annual water yield at the North (NFC) and South Fork (SFC) weirs. Departures are relative to predictions using 1963-1971 calibration regression. SFC was roaded in 1967 and logged 1971-1973. NFC was logged in 1985 and 1989-1991.

logging. Mid-summer pipeflow discharges were compared between pipe M106 (control) and K201 (logged in 1989) using regression analysis. Manual measurements of discharge during late July for years 1987 to 1989 were used to determine the calibration relationship. Postlogging measurements from 1990 to 1996 were then compared to this calibration relationship using prediction limits ($p < 0.05$).

Tensiometer data were evaluated nonstatistically to further explore the NFC response to logging. At the K2-site, soil moisture tensions were compared on July 1 before and after logging. Maximum seasonal tensions were also compared where available. Because of equipment limitations, these latter data were not always reliable.

Results

Annual Yield

Selection cutting and tractor yarding increased SFC annual yield by

an average 15 percent or 932 m³ha⁻¹yr⁻¹ over an 11-year period (*fig. 1*). Statistically significant ($p < 0.05$) increased yields began in 1973 (two years after logging began) and continued through 1985 (excepting 1983 and 1984). The largest increase was 2,053 m³ha⁻¹yr⁻¹ (30 percent) in 1978, seven years after SFC logging began and one year after the record drought of 1977 (*table 1*).

Partial clearcut logging with mostly skyline cable yarding on the NFC resulted in a similar water yield increase (*fig. 1*). The average increase between 1990 and 1997 was 15 percent or 608 m³ha⁻¹yr⁻¹. Except for 1993, these increases were statistically significant ($p < 0.05$) beginning in 1992 through 1997, the last year available for analysis. The largest absolute increase was 1,032 m³ha⁻¹yr⁻¹ in 1997, but proportionately, the greatest relative increase was 29 percent in 1994 (*table 1*).

Summer Low Flows

On SFC, the minimum summer discharge (instantaneous mean

Table 1—Annual water yield at the North Fork (NFC) and South Fork (SFC) Caspar Creek weirs and departures from predicted yields, based on 1963 to 1971 calibration regression ($r^2 = 0.99$). Mean, maximum, and minimum departures and percent change are for postlogging years (SFC: 1973-1982, NFC: 1990-1997). Bold values exceed calibration prediction limits ($p < 0.05$). No values are less than the lower prediction limit.

Water Year	NFC m ³ ha ⁻¹ yr ⁻¹	SFC m ³ ha ⁻¹ yr ⁻¹	SFC Departure m ³ ha ⁻¹ yr ⁻¹	SFC Change (percent)	NFC Departure m ³ ha ⁻¹ yr ⁻¹	NFC Change (percent)
1963	5283	5269	-46	-1	42	1
1964	3541	3489	-190	-5	179	5
1965	7210	7008	-116	-2	132	2
1966	4943	5067	72	1	-85	-2
1967	6929	6832	-28	0	37	1
1968	3747	4093	220	6	-252	-6
1969	8184	8229	191	2	-183	-2
1970	6986	6984	71	1	-66	-1
1971	7447	7172	-174	-2	196	3
1972	3730	3826	-32	-1	13	
1973	8093	8981	1029	13	-1069	
1974	13054	13707	1099	9	-1100	
1975	7932	8722	921	12	-956	
1976	3337	4019	531	15	-584	
1977						
1978	6898	8884	2053	30	-2161	
1979	4111	4880	665	16	-719	
1980	6289	6748	489	8	-514	
1981	2754	3649	707	24	-776	
1982	9812	10455	890	9	-907	
1983	13919	13510	90	1	-27	
1984	6782	6939	217	3	-222	
1985	3646	4454	676	18	-734	
1986	6265	6193	-44		48	1
1987	3337	3883	394		-440	-12
1988	3560	3786	88		-115	-3
1989	4239	4734	399		-438	-9
1990	3903	3798	-222		216	6
1991	1754	1677	-326		307	21
1992	3227	2711	-674		688	27
1993	8267	7723	-393		434	6
1994	2827	2381	-629		637	29
1995	10238	9363	-602		672	7
1996	7676	6746	-816		876	13
1997	7833	6746	-962		1032	15
Mean	6110	6255	932	15	608	15
Maximum	13919	13707	2053	30	1032	29
Minimum	1754	1677	489	8	216	6

daily flow) increased an average of 38 percent or $0.25 \text{ L s}^{-1} \text{ km}^{-2}$ between 1972 and 1978. The maximum increase was $0.42 \text{ L s}^{-1} \text{ km}^{-2}$ in 1973, the final year of timber harvesting on this watershed. No increases were detected in 1977, the driest year of record. Summer discharge minimums returned to prelogging levels beginning in 1979 (*table 2*).

The NFC response to timber harvesting operations yielded increased minimum summer discharges, as well. *Figure 2* compares changes in minimum summer discharge levels for SFC and NFC. Even after clearcutting only 12 percent of the watershed, a 161 percent ($0.30 \text{ L s}^{-1} \text{ km}^{-2}$) increase was detected in 1986. Between 1990 and 1997, minimum summer discharge averaged 148 percent ($0.40 \text{ L s}^{-1} \text{ km}^{-2}$) greater than preharvest predictions. The minimum increase was 75 percent in 1990 and 1996. The largest relative

increase was 287 percent in 1992, but the maximum absolute increase, $0.67 \text{ L s}^{-1} \text{ km}^{-2}$, occurred in 1997 (*table 2*).

Other Summer Season Baseflow Indicators: North Fork Caspar

Additional indications of summer flow increases after the NFC logging were observed further up the watershed. Minimum summer stages in the tributary basins are shown in *figure 3*. Before logging, all of the sub-basin gaging stations were seasonally dry, with the exception of the three mainstem rated sections (ARF, FLY, and LAN) and three tributary stations (DOL, IVE, and KJE). Even with higher rainfall after the NFC logging, this pattern of no flow continued at the control gages, HEN and MUN. However, of the remaining five gaging

Table 2—Minimum instantaneous mean daily flow at North Fork (NFC) and South Fork (SFC) Caspar Creek weirs and departures from predicted values, based on 1963 to 1971 calibration regression ($r^2 = 0.96$). Mean, maximum, and minimum departures and percent change are for postlogging years (SFC: 1972-1978, NFC: 1990-1997). Bold values exceed calibration prediction limits ($p < 0.05$). No values are less than lower prediction limit.

Year	NFC $\text{L s}^{-1} \text{ km}^{-2}$	SFC $\text{L s}^{-1} \text{ km}^{-2}$	SFC Departure $\text{L s}^{-1} \text{ km}^{-2}$	SFC Percent Change	NFC Departure $\text{L s}^{-1} \text{ km}^{-2}$	NFC Percent Change
1963	0.72	1.24	-0.02	-2	0.03	4
1964	0.17	0.23	-0.08	-26	0.04	27
1965	0.29	0.46	-0.05	-10	0.03	10
1966	0.22	0.30	-0.08	-20	0.04	22
1967	0.40	0.78	0.09	13	-0.05	-11
1968	0.22	0.46	0.07	19	-0.04	-17
1969	0.26	0.52	0.07	16	-0.04	-14
1970	0.16	0.29	0.02	7	-0.02	-10
1971	0.46	0.78	-0.02	-3	0.02	4
1972	0.34	0.99	0.40	69	-0.22	
1973	0.37	1.06	0.42	66	-0.23	
1974	0.43	1.10	0.35	47	-0.19	
1975	0.55					
1976	0.36	0.80	0.17	28	-0.09	
1977	0.18	0.29	-0.02	-7	0.01	
1978	0.43	0.95	0.20	26	-0.10	
1979	0.64	0.93	-0.19	-17	0.12	
1980	0.54	0.90	-0.04	-5	0.03	
1981	0.28	0.46	-0.03	-6	0.02	
1982		0.63				
1983	0.74	1.10	-0.19	-15	0.12	
1984	0.28	0.41	-0.08	-17	0.05	
1985	0.23	0.29	-0.10	-26	0.05	
1986	0.49	0.32	-0.53		0.30	161
1987	0.23	0.25	-0.14		0.08	50
1988	0.26	0.29	-0.17		0.09	52
1989	0.46	0.59	-0.22		0.13	37
1990	0.41	0.40	-0.31		0.17	75
1991	0.46	0.21	-0.59		0.33	256
1992	0.59	0.25	-0.77		0.44	287
1993	1.28	1.10	-1.12		0.66	107
1994	0.46	0.29	-0.51		0.29	166
1995	0.72	0.67	-0.58		0.34	89
1996	0.80	0.80	-0.58		0.34	75
1997	1.19	0.92	-1.15		0.67	129
Mean	0.46	0.62	0.25	38	0.40	148
Maximum	1.28	1.24	0.42	69	0.67	287
Minimum	0.16	0.21	-0.02	-7	0.17	75

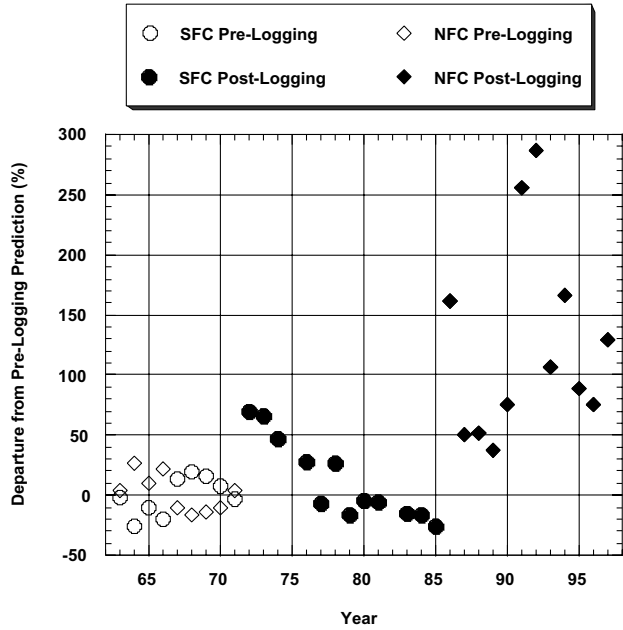

Figure 2—Minimum summer discharge at the North Fork (NFC) and South Fork (SFC) weirs. Departures are relative to predictions using 1963-1971 calibration regression. SFC was roaded in 1967 and was logged in 1971-1973. NFC was logged in 1985 and 1989-91.

sites known to cease flowing during the summer season before logging (BAN, CAR, EAG, GIB, and JOH), all had surface flow well into the summer period after logging. Instrumentation problems prevented analysis of the GIB and IVE data. For the remaining tributary sites, the mean postlogging minimum stage was greater than the predisturbance value according to both the *t*-test and the Mann-Whitney test statistics (*table 3*).

Large increases in late-July soil pipeflow from the 100 percent clearcut K2 swale were detected in 1990 to 1992, and 1994 (*fig. 4*). Increases in this mid-summer pipeflow variable averaged 179 percent or 0.45 L min⁻¹. The largest increase, 478 percent or 0.95 L min⁻¹, occurred in 1991. After 1994, K201 pipeflow fell below the calibration prediction, but this was not a statistically significant decrease (*table 4*). Because the range of the pretreatment calibration (1987-1989) only extended to about 0.3 L min⁻¹, observations during 1990, 1993, 1995, and 1996 required extrapolation of this calibration and the departures are suspect. However, it appears that summer pipeflow increases were greater the first and second year (1990 and 1991) after logging and returned to near pretreatment levels by 1993 or 1994.

After logging, tensiometer gages in watershed KJE indicated reduced tensions (higher soil moisture) on July 1. For example, at a depth of 150 cm at site C4, tensions on July 1 were 55 and 32 cb for the 2 years before logging. After logging on July 1 tensions did not

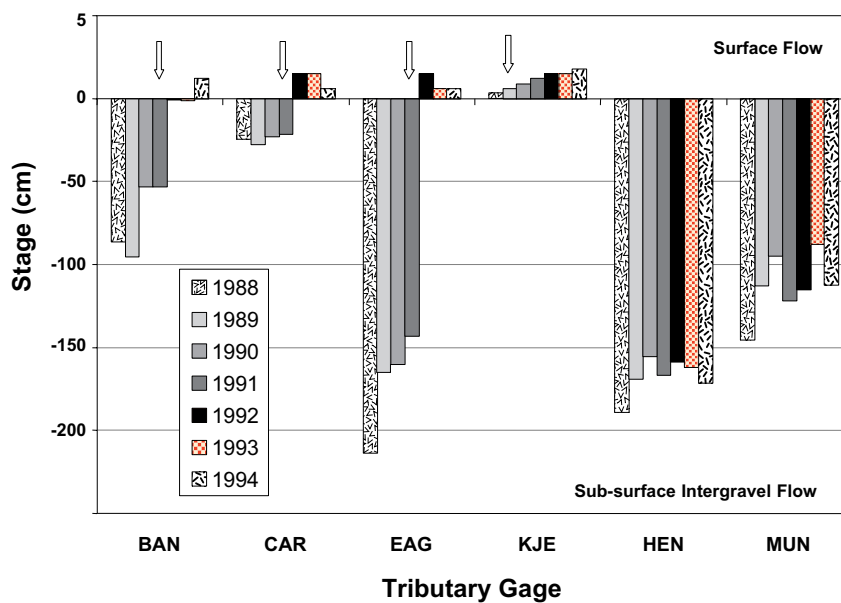

Figure 3—Minimum summer stages at clearcut tributary gages (BAN, CAR, EAG, KJE) and unlogged control gages (HEN, MUN). Positive stage values indicate surface flow persisted for the entire water year. Negative values indicate the minimum intergravel flow level measured at the instream well tube. Arrows indicate time of logging.

Table 3—Minimum summer stages (cm) at North Fork Caspar Creek tributary gages. Positive values indicate continuous surface flow. Negative stages indicate intergravel flow level observed in well tube.

Year	100 percent clearcut subwatersheds				Control subwatersheds	
	BAN	CAR	EAG	KJE	HEN	MUN
1988	-86.3	-24.4	-213.4	0.3	-189.0	-145.7
1989	-95.1	-27.4	-164.6	0.6	-169.2	-112.8
1990	-53.3	-22.9	-160.0	0.9	-155.4	-94.8
1991	-53.0	-21.3	-143.3	1.2	-166.7	-121.9
1992	-0.6	1.5	1.5	1.5	-158.5	-114.9
1993	-1.2	1.5	0.6	1.5	-162.2	-87.8
1994	1.2	0.6	0.6	1.8	-171.6	-112.2
Prelogging mean	-71.9	-24.0	-170.3	0.5	-171.2	-117.8
Postlogging mean	-0.2	1.2	0.9	1.4	-164.7	-106.3
Year logging completed	Winter 1991	Winter 1991	Fall 1991	Fall 1989	Not logged	Not logged

Table 4—July pipeflow at the uncut control M106 and the logged K201 North Fork Caspar Creek sites and departures from predicted values based on 1987-1989 calibration regression ($r^2 = 0.99$). K201 was logged in 1989. Bold values exceed calibration prediction limits ($p < 0.05$). No values are below prediction limits.

Year	M106 (L min ⁻¹)	K201 (L min ⁻¹)	K201 Departure (L min ⁻¹)	K201 change (percent)
1987	0.150	0.185	0.009	5
1988	0.060	0.060	-0.005	-7
1989	0.250	0.295	-0.004	-1
1990	0.800	2.000	1.022	104
1991	0.170	1.160	0.959	478
1992	0.160	0.666	0.478	254
1993	1.245	1.160	-0.367	-24
1994	0.190	0.420	0.195	86
1995	0.670	0.585	-0.233	-28
1996	1.100	0.730	-0.618	-46
Mean (1990-1994)			0.457	180
Maximum			1.022	478
Minimum			-0.618	-46

exceed 10 cb. Similarly, maximum tensions at this site were 84 cb and 74 cb before logging, but never exceeded 60 cb in the postlogging monitoring period (fig. 5). In other words, postharvest soil moisture levels throughout the summer dry season were at or above the preharvest levels. This suggests additional soil moisture was available to support forest regrowth. Unfortunately, much of the tensiometer data was interrupted or discontinued after 1993 because of equipment problems and vandalism. It would be interesting to see if the soil moisture tensions have returned to prelogging levels as apparently the pipeflow has done.

Discussion

The Caspar Creek Response

These data clearly indicate that streamflow was enhanced after timber harvest operations in the NFC and SFC. Significant increases

were detected in both summer flows and annual water yield. Previous analyses (Keppeler and Ziemer 1990, Ziemer and others 1996) have shown similar results although the stated magnitudes and duration of postlogging flow enhancement have varied according to the definitions of the streamflow variables and calibration years, and the length of the data set.

As previously noted (Henry, these proceedings) the Caspar Creek watersheds receive annual precipitation averaging 1,200 mm (45 inches). However, not all of this precipitation is routed to the channel as streamflow. Perhaps 10 to 15 percent of this precipitation is intercepted by the forest canopy and evaporated back into the atmosphere without contacting the ground. A minor amount of precipitation may percolate through the entire soil profile to bedrock fissures and into deep groundwater supplies, thus escaping our stream gaging instrumentation. Less than 50 percent of annual rainfall is measured as streamflow at the North

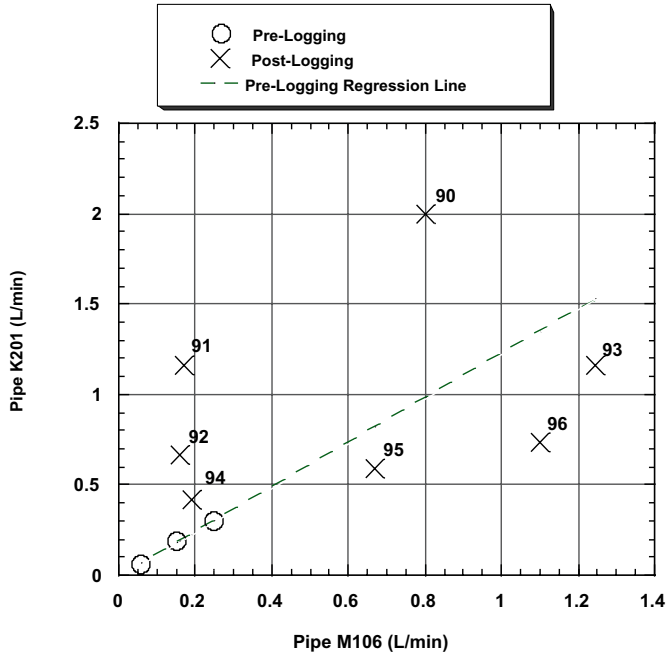

Figure 4—Summer (late July) pipeflow measured at the pipe K201 (K2-site logged 1989) and the control pipe M106 (M1-site untreated). Calibration regression (solid line) uses years 1987-1989. Dashed line is extrapolation of regression line beyond calibration data.

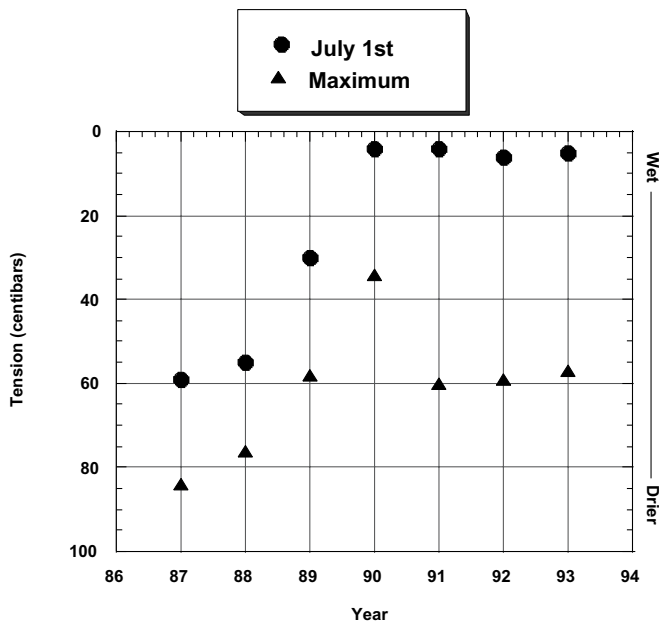

Figure 5—Soil moisture tension at 150 cm depth at the K2-site before and after the August 1989 logging.

and South Fork weirs (Ziemer 1997). Most of the remainder infiltrates into the soil where it is eventually absorbed by plant roots and transpired by forest vegetation.

It has long been acknowledged that evapotranspiration dominates the water balance over most of the landmass. Potential evapotranspiration (PET) is the return of water to the atmosphere by vegetation unrestrained by soil water limitations. Using the Thornthwaite method, Ziemer (1997) calculates annual PET at Caspar Creek to be 660 mm or about half of annual rainfall. During the months of May through September, water demand by the vegetation (or PET) far exceeds rainfall inputs; thus stored soil moisture is depleted. As soil water is depleted by subsurface drainage and plant use, actual evapotranspiration is greatly reduced. Removal of vegetation by timber harvest, forest fire, or other means will most heavily affect the evapotranspiration component of this water balance.

In light of this, the streamflow enhancements observed at Caspar Creek are not unexpected. In reviewing the results of 11 watershed studies in the Pacific Northwest, Harr (1979) reported increased annual water yields of up to 620 mm. At Caspar Creek, the increase was far more modest, averaging less than 100 mm. This is not surprising given that absolute increases due to timber harvest are largest in high rainfall areas and Caspar Creek is at the southernmost extension of this region. If we accept that the PET of the fully forested NFC watershed was 660 mm, then logging 50 percent of the timber volume could reduce plant water use by about half, at most (a savings on the order of 300 mm), under conditions where soil moisture is unlimited. However, *actual* evapotranspiration from this site is certainly limited by soil moisture levels during the dry summer months, thus lesser enhancement is expected. The average postlogging increase at Caspar Creek was less than one third of the potential amount. Cutting trees reduces, but does not eliminate transpiration. Residual and new understory vegetation in the cutblocks probably responded to increased soil moisture by increasing transpiration. Evaporation from exposed hillslope surfaces continued, and possibly increased, after logging. Also, at NFC, the riparian vegetation was mostly retained. Riparian trees and vegetation use more water than the forested hillslopes.

Harr's review also reports that summer flows elsewhere have been as much as quadrupled. After the NFC logging, minimum summer discharge almost tripled during one postlogging year, but averaged about 150 percent after clearcutting 50 percent of the watershed area. The largest increases noted in Harr's analysis occurred where complete clearcutting was done. At the fully clearcut K2-site on the NFC, the magnitude of summer pipeflow increases were similar to the maximums that Harr reports. The largest relative increases in summer minimum flows occurred after Caspar Creek's two driest rainfall years on record, 1977 and 1991.

Why were the summer flow increases larger and more persistent at NFC compared to SFC after logging? The harvest prescription appears to be the important factor. In the SFC selection cut, single trees and small groups were logged, leaving a dispersed residual timber stand and understory vegetation ready to take advantage of any soil moisture surpluses occurring after harvest. In

the NFC clearcuts, soil water surpluses occurred in discrete cutblocks where only peripheral contact with residual vegetation existed. New vegetation must grow, or, in the case of redwoods and some hardwood species, resprout, and develop ample foliage to make full use of stored soil water. The postharvest site treatments may also play a part in the magnitude and duration of flow enhancements. About 20 percent of the NFC watershed area was broadcast burned after harvest. One half of the cutblocks were burned approximately one year postharvest, thus setting back the regenerating vegetation. In addition, these burned units were later treated with herbicide to control competition from brush species, also setting back the recovery of the vegetation. The YZ 1985 timber sale was precommercially thinned in 1995, once again pushing back the recovery of that portion of the NFC watershed. Additional precommercial thinning is planned for other NFC cutblocks beginning with Unit K this year (1998). Although the NFC cutblocks are now green and the regeneration appears to be growing vigorously, water use by the new vegetation appears to remain far below that of the older second-growth forest in the NFC watershed. Evapotranspiration is a function of total leaf area. Leaf area in the revegetating cutblocks remains far below that of the uncut portions of the watershed.

The Role of Fog

What is the role of fog and fog precipitation in the postlogging water balance at Caspar Creek? Literature suggests that fog plays a crucial role in the ecology of the Pacific Northwest. In this region, warm, moist air contacts cool coastal waters, lowering temperatures below the dew point and forming fog. This fog layer may travel far inland depending on the strength of the onshore breeze and local topography. The Coast Range forms a partial barrier to this marine layer, preventing penetration to inland areas except where breaks in topography occur such as along river valleys. Fog dissipates when sufficient warming of the airmass occurs to raise temperatures and re-evaporate the fog droplets. When summer fog blankets the forest, relative humidity is increased while insolation and temperature are decreased, thus reducing transpiration by the vegetation. Summer fog influences the species composition of the coastal forest. Lacking stomatal control, the coast redwood is limited to a narrow belt along the California and southern Oregon coastlines, in large part because of the prevalence of summer fog.

Fog precipitation, or fog drip, occurs when fog droplets encounter an obstruction, coalesce, and fall to the ground. This phenomenon is largely limited to exposed ridges or crests during periods of cool temperatures less than 10 °C (Freeman 1971). The redwood, Douglas-fir, and spruce forest canopy is particularly efficient at intercepting water droplets and inducing fog drip. Kittredge (1948) reported that 285 mm of fog drip was collected during one summer season under an 85-year-old spruce/hemlock stand in coastal Oregon. Azevedo and Morgan (1974) reported seasonal fog drip totaling as much as 425 mm in northern California's Eel River valley. More recently, Dawson (1996) concluded that 8 to 34 percent of the water used by the coast redwood and 6 to 100 percent of water used by understory vegetation originated as fog precipitation at his study site on a

hillslope near the mouth of the Klamath River. Ingraham (1995) analyzed fog, rain, and groundwater samples from the Point Reyes Peninsula and found that the isotopic composition of groundwater reflects the contribution of fog water.

Fog drip has not been measured at Caspar Creek. However, field observations suggest that it does occur. The frequency of daytime fog can be discerned from solar pyranometer data collected at a Caspar Creek site since 1988. Summer fog within the experimental watershed area is far less frequent than in coastal Mendocino County because of the more inland location of our study site. Along the coast, 30 to 50 percent of days during June, July, and August have morning fog (Goodridge 1978). At Caspar Creek, solar radiation data collected between 1988 and 1994 indicate that only 10 to 35 percent of the June-through-August days have insolation reduced by more than about one-third because of fog or cloud cover.

Did logging reduce fog drip? The removal of the forest canopy, especially near the ridges, probably resulted in less fog interception and drip. The pipeflow swales are located near the ridge in the NFC headwaters. Here, one might expect fog drip to play a more prominent role in the water balance than in the watershed overall, but July pipeflow increased dramatically during the first few postlogging seasons, suggesting that this was not the case. July measurements for 1995 and 1996 at K201 were below the predicted levels, but this reduction was not statistically significant. At some point during postharvest recovery, one might expect that evapotranspiration rates will return to preharvest levels while the forest canopy is not yet functioning as an effective fog drip collector. This has yet to be documented and thus remains hypothetical. Because these finer nuances of postlogging recovery will be difficult to detect at the weirs before additional timber harvest commences, continued evaluation of the postlogging summer discharge trend at the pipeflow sites is warranted.

Perhaps the smaller postharvest streamflow increases observed on SFC relate, in part, to this loss of fog drip. It is quite plausible that SFC receives more fog than NFC because of its proximity to the coast, but this has not been documented. What has been documented is a measurable postharvest increase in streamflow at both the NFC and SFC weirs, as well as increased soil moisture and pipeflow in the NFC watershed. If fog drip were an important component of the hydrology of Caspar Creek, we would have seen a *decrease* in soil moisture, pipeflow, and streamflow in the cut units, not the *increase* reported here.

Ecological Ramifications

The impacts of the Caspar Creek harvest treatments on stream and riparian ecology are more difficult to discern than the physical changes. An increase in summer discharge implies that the stream is less susceptible to water temperature increases. Maximum water temperatures increased about 9 °C (from 16 °C to 25 °C) after right-of-way clearing and road-building in the SFC riparian zone (Krammes and Burns 1973). Increased summer flows did not buffer these temperature effects. On the NFC, stream temperature changes after logging were not significant (Cafferata 1990, Nakamoto, these proceedings). The use of stream-side canopy retention zones on Class I and II channels was probably far more important in

preventing increases in stream temperature than the summer streamflow enhancement.

Perhaps a more important effect of enhanced summer discharges is the increase in aquatic habitat developed in the channel. Higher discharge levels increased habitat volumes, and, as witnessed at the tributary gages, lengthened the flowing channel network along logged reaches. Nakamoto (these proceedings) concludes that the amount of slow water habitat on the NFC increased after logging, but reports no corresponding increase in biomass of stream vertebrates.

In terms of both stream temperature and habitat availability, the summer flow enhancements are of greater importance than the increases in total annual water yield because it is during the summer streamflow recession that temperature and habitat carrying capacity are most critical. However, these discharge impacts are variable and relatively short-lived. Impacts of timber harvest associated with effects other than summer flow increases appear to be of greater significance to the ecology of Caspar Creek, as the other reports in these proceedings illustrate.

Conclusions

The Caspar Creek watershed studies reveal increased water yields and summer flows after timber harvesting. Increases observed at this site were more modest than those documented at other sites in the Pacific Northwest. Streamflow changes due to logging were most evident during the long, dry summer season. During this prolonged recession, zones of deep perennial saturation maintain streamflow (baseflow). After logging, reduced evapotranspiration allows for additional water to be stored and routed to streams as summer streamflow. At Caspar Creek, enhanced soil moisture in the rooting zone followed timber harvest in the North Fork clearcut units. Previously intermittent stream reaches and soil pipes became perennial. The larger increases in minimum flows observed on the North Fork are probably due to wetter soils in the clearcut units where minimal vegetation exists to use this enhanced moisture. On the South Fork, older second-growth residual forest vegetation more readily exploited this additional soil moisture.

Fog plays an important role in the regional ecology by moderating evapotranspiration. However, Caspar Creek data indicate that any possible postlogging loss of fog drip does not result in a net reduction in streamflow. Moisture savings due to reduced evapotranspiration appear to override fog precipitation losses at this site.

Continued monitoring will document the duration of summer flow increases due to the most recent North Fork logging only as long as additional harvest operations are postponed in both the North and South Fork watersheds. Fortunately, the M1 and K2 pipeflow sites provide the opportunity for continued evaluation of the effects of clearcutting on the baseflow processes without the complications caused by further harvest operations in the greater watershed area. Quantification of fog drip within the Caspar Creek watershed warrants investigation in light of the documented importance of this moisture source at some sites in the Pacific Northwest.

References

- Azevedo, J.; Morgan, D.L. 1974. **Fog precipitation in coastal California forests.** *Ecology* 55: 1135-1141.
- Cafferata, Peter H. 1990. **Temperature regimes of small streams along the Mendocino coast.** Jackson Demonstration State Forest Newsletter, No. 39, October 1990. p. 4-7.
- Dawson, Ted E. 1996. **The use of fog precipitation by plants in coastal redwood forests.** In: LeBlanc, John, ed. Conference on coast redwood forest ecology and management; 1996 June 18-20; Arcata, CA. Berkeley, CA: University of California; 90-93.
- Freeman, Gary J. 1971. **Summer fog drip in the coastal redwood forest.** Arcata, CA: Humboldt State Univ.; 101 p. M.S. thesis.
- Goodridge, James D. 1978. **Climate summaries of California airports.** Sacramento, CA: California Dept. of Water Resources.
- Harr, R. Dennis. 1979. **Effects of streamflow in the rain-dominated portion of the Pacific Northwest.** In: Proceedings of workshop on scheduling timber harvest for hydrologic concerns; 1979 November 27-29. Portland, OR: Pacific Northwest Forest and Range Experiment Station, Forest Service, U.S. Department of Agriculture; 45 p.
- Harr, R. Dennis. 1982. **Fog drip in the Bull Run Municipal Watershed, Oregon.** *Water Resources Bulletin* 18(5): 785-789.
- Hibbert, A.R. 1967. **Forest treatment effects on water yield.** In: Sopper, William E.; Lull, Howard W., eds. Forest hydrology. Proceedings of a National Science Foundation advanced science seminar; 1965 August 29 - September 10; University Park, PA. New York: Pergamon Press; 527-543.
- Ingraham, N.L. 1995. **The importance of fog-drip water to vegetation: Point Reyes Peninsula, California.** *Journal of Hydrology* 164: 269-285.
- Ingwersen, J.B. 1985. **Fog drip, water yield, and timber harvesting in the Bull Run municipal watershed.** *Water Resources Research* 21(3): 469-473.
- Keppeler, Elizabeth T.; Ziemer, Robert R. 1990. **Logging effects on streamflow: water yields and summer low flows at Caspar Creek in northwestern California.** *Water Resources Research* 26(7): 1669-1679.
- Kittredge, Joseph. 1948. **Forest influences.** Dover, NY: McGraw-Hill Book Co.; 418 p.
- Krammes, J.S.; Burns, D.M. 1973. **Road construction on Caspar Creek watersheds — a 10-year progress report.** Research Paper PSW-93. Berkeley, CA: Pacific Southwest Forest and Range Experiment Station, USDA Forest Service; 10 p.
- Rothacher, Jack. 1971. **Regimes of streamflow and their modification by logging.** In: Proceedings of the symposium on forest land use and stream environment; Corvallis, OR. Corvallis, OR: Oregon State University, 55-63.
- Ziemer, Robert R.; Lewis, Jack; Keppeler, Elizabeth T. 1996. **Hydrologic consequences of logging second-growth watersheds.** In: LeBlanc, John, ed. Conference on coast redwood forest ecology and management; 1996 June 18-20; Arcata, CA. Berkeley, CA: University of California; 131-133.
- Ziemer, Robert R. 1997. **Caspar Creek Thornthwaite potential evapotranspiration, water years 1990-1995.** Website <http://www.rsl.psw.fs.fed.us/projects/water/Thornthwaite.html>; 1 p.

Effects of Forest Harvest on Stream-Water Quality and Nitrogen Cycling in the Caspar Creek Watershed¹

Randy A. Dahlgren²

Abstract: *The effects of forest harvest on stream-water quality and nitrogen cycling were examined for a redwood/Douglas-fir ecosystem in the North Fork, Caspar Creek experimental watershed in northern California. Stream-water samples were collected from treated (e.g., clearcut) and reference (e.g., noncut) watersheds, and from various locations downstream from the treated watersheds to determine how far the impacts of these practices extended. Additionally, a detailed nutrient cycling study was performed in a clearcut and reference watershed to gain insights into changes in nitrogen cycling after harvesting activities.*

Stream-water nitrate concentrations were higher in clearcut watersheds, especially during high stream discharge associated with storm events. Elevated concentrations of nitrate were due to increased leaching from the soil as mineralization (i.e., release of nutrients from organic matter) was enhanced and nutrient uptake by vegetation was greatly reduced after harvest. The elevated nitrate concentration in stream water from clearcut watersheds decreased in the higher-order downstream segments. This decrease is believed to be primarily due to dilution, although in-stream immobilization may also be important. Although elevated nitrate concentrations in stream water from the clearcut watershed might suggest a large nitrogen loss after clearcutting, conversion to a flux indicates a maximum loss of only 1.8 kg N ha⁻¹ yr⁻¹; fluxes decreased to <0.4 kg N ha⁻¹ yr⁻¹ 3 years after the harvest. Nitrogen fluxes from the reference watershed over the same period were <0.1 kg N ha⁻¹ yr⁻¹. The increased nitrogen flux was due to both higher nitrate concentrations and an increased water flux from the clearcut watershed.

*In contrast to many forest ecosystems that show large nutrient losses in stream water after harvest, this redwood/Douglas-fir ecosystem shows relatively small losses. The rapid regrowth of redwood stump sprouts, which use the vast rooting system from the previous tree, is capable of immobilizing nutrients in its biomass, thereby attenuating nutrient losses by leaching. Rapid regeneration also provides soil cover that appreciably reduces the erosion potential after harvest. Removal of nitrogen, primarily in the harvested biomass, results in an appreciable loss of nitrogen from the ecosystem. These data suggest that nitrogen fixation by *Ceanothus* may be an important nitrogen input that is necessary to maintain the long-term productivity and sustainability of these ecosystems.*

The effects of forest harvest and postharvest practices on nutrient cycling were examined for a redwood/Douglas-fir ecosystem in the North Fork, Caspar Creek experimental watershed in northern California. This ecotype is intensively used for commercial timber production, and streams draining these ecosystems are an important salmon-spawning habitat. Although the effects of forest

harvest practices on stream flow and sediment generation have been intensively studied (e.g., Keppeler and Ziemer 1990, Rice and others 1979, Thomas 1990, Wright and others 1990, Ziemer 1981, and papers contained in these proceedings), the impacts of harvest practices on nutrient cycling processes have not been rigorously examined for the coastal region of northern California.

Water quality and long-term nutrient sustainability are major components addressed within the ecosystem approach to forest management (Swanson and Franklin 1992). Forest harvest practices are often considered to have adverse impacts on water quality and sensitive aquatic communities owing to enhanced sediment and nutrient losses due to erosion and leaching (Hornbeck and others 1987, Likens and others, 1970, Martin and others 1986). The loss of plant nutrients in drainage waters, suspended sediments, and biomass removed by harvesting may further affect nutrient sustainability of forest ecosystems (Hornbeck and others 1987, Johnson and others 1982, 1988). Sustainable forestry is based on the premise of removing essential nutrients at a rate less than or equal to that which can be replenished by natural processes. As forest ecosystems become more intensively managed, it is imperative that best-management practices be developed and used to minimize environmental impacts and assure long-term ecosystem sustainability.

This paper specifically examines the effects of forest harvest and postharvest management practices on the nitrogen cycle because nitrogen is the mineral nutrient required in the largest amount by the vegetation and it is believed to be the most limiting nutrient in this ecosystem. In addition, results for 10 additional nutrients are available in the final project report (Dahlgren 1998). This research uses a biogeochemistry approach to nutrient cycling that examines processes and interactions occurring within and between the atmosphere, hydrosphere, biosphere, and geosphere (*fig. 1*). The process-level information obtained can be used to decipher the complex interactions that occur in nutrient cycling processes at the ecosystem scale. Results from this research can be applied to the development of best-management practices to maintain long-term forest productivity while minimizing adverse environmental impacts from forest management.

Methods

Study Site Characteristics

Headwater catchments in the North Fork of Caspar Creek were selected for this study (*fig. 2*). The watersheds are located in the Jackson Demonstration State Forest, 11 km southeast of Fort Bragg, California, and approximately 7 km from the Pacific Ocean. The North Fork of Caspar Creek has a drainage area of 473 ha and

¹ An abbreviated version of this paper was presented at the Conference on Coastal Watersheds: The Caspar Creek Story, May 6, 1998, Ukiah, California.

² Professor of Soil Science and Biogeochemistry, University of California, Department of Land, Air and Water Resources, One Shields Avenue, Davis, CA 95616. (radahlgren@ucdavis.edu)

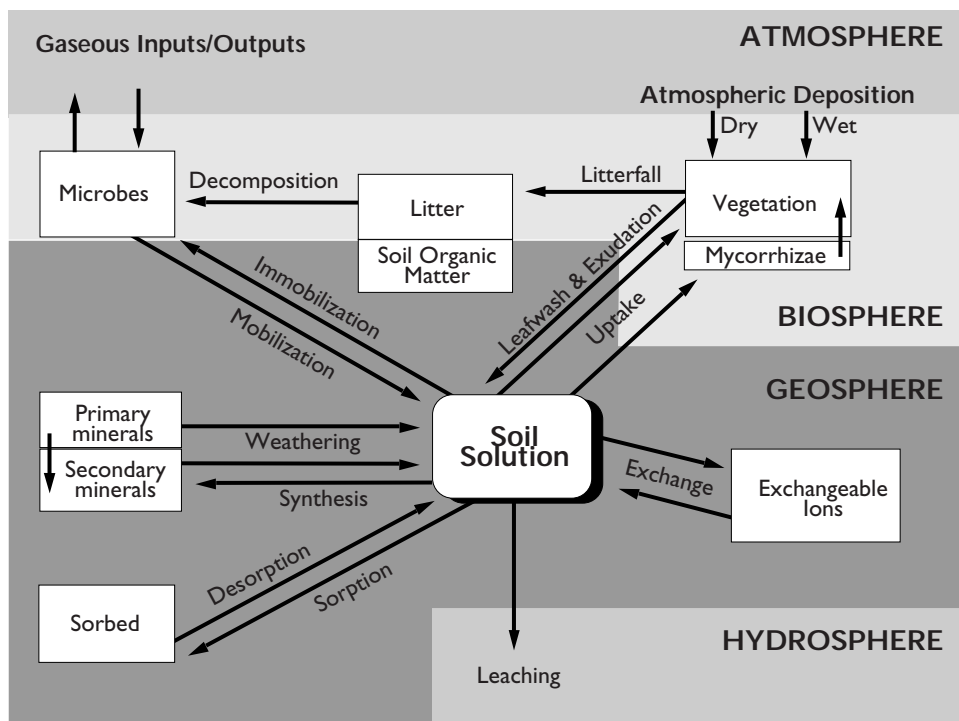

Figure 1—Nutrient cycles consist of a series of interrelated processes occurring within and between the atmosphere, hydrosphere, biosphere, and geosphere. Each nutrient is linked through a set of specific interconnected steps that ultimately lead to a series of cyclic pathways.

ranges in elevation from 37 to 320 m. The topography of the North Fork watersheds ranges from broad, rounded ridgetops to steep inner gorges. Slopes within the watershed are <30 percent (35 percent of the area), 30-70 percent (58 percent of area), and >70 percent (7 percent of the area) (Wright and others 1990).

The climate is Mediterranean, having dry summers with coastal fog and mild temperatures ranging from 10 to 25 °C. Winters are mild and wet, with temperatures ranging between 5 and 14 °C. The average annual rainfall is about 1,200 mm with no appreciable snowfall (Ziemer 1981). Soils are dominated by well-drained Ultic Hapludalfs and Typic Haplohumults formed in residuum derived predominately from sandstone and weathered coarse-grained shale of Cretaceous Age.

The North Fork of Caspar Creek was originally clearcut logged and burned in approximately 1910 (Tilley and Rice 1977). Current vegetation is dominated by second-growth redwood (*Sequoia sempervirens* (D. Don) Endl.) and Douglas-fir (*Pseudotsuga menziesii* (Mirb.) Franco) with minor associated western hemlock (*Tsuga heterophylla* (Raf.) Sarg.) and grand fir (*Abies grandis* (Dougl.) Lindl.). The mean stand density based on cruise data from three watersheds was 207 redwood stems ha⁻¹ (mean DBH = 56 cm) and 86 Douglas-fir stems ha⁻¹ (mean DBH = 66 cm). Timber volume at the onset of this study before logging was estimated at about 700 m³ ha⁻¹ (Krammes and Burns 1973).

Solid-Phase Soil Analyses

Sites for six soil pits were randomly selected within a clearcut (KJE) and reference (MUN) watershed (*fig. 2*). Soil pits (1.5 by 0.5 by 1-1.2 m; L × W × D) were excavated to a depth corresponding to the limit of the major rooting zone (BC horizon; 100-120 cm). Each pedon was described, and soil samples for chemical analyses and clods for bulk density measurements were collected from across the entire pit face for each morphological horizon. All soil samples were collected during September 1992, the month during which the soil is driest.

Soil samples were air-dried, gently crushed, and passed through a 2-mm sieve; roots passing through the sieve were removed with a forceps. Bulk density was determined by the paraffin-coated clod method using three replicate clods per horizon (Soil Survey Staff 1984). Total carbon and nitrogen were determined on ground samples (<250 μm) by dry combustion with a C/N analyzer. Soil carbon and nitrogen pools (kg ha⁻¹) were calculated for each soil profile (n = 6) by summing the nutrient content of all horizons within the major rooting zone. Nutrient pools for each horizon were determined from the nutrient concentration in the <2 mm fraction, mean horizon thickness, and bulk density of each horizon with a correction for the coarse fragment (>2 mm) volume.

Collection and Analysis of Ecosystem Waterflows

The chemistry of ecosystem waterflows along the hydrologic cycle (e.g., precipitation, canopy throughfall, soil solution, and streamflow) was used to compare nutrient cycling processes in the clearcut (KJE) and reference (MUN) watersheds for 3 water years commencing 1 October 1993 and ending 30 September 1996. Samples were collected on a monthly basis during the rainy season (November-May) and on an event basis as necessary outside of the rainy season. Bulk precipitation was collected from duplicate sites within the clearcut watershed (KJE). Bulk precipitation collectors are effective in capturing the wetfall component but have been shown to only partially capture the dryfall (particulate and gases) relative to the collection efficiency of a forest canopy (Lindberg and others 1986). Thus, bulk precipitation fluxes probably underestimate the total atmospheric deposition to a forest ecosystem. Canopy throughfall was collected in triplicate from beneath the canopy of redwood and Douglas-fir in the area adjacent to the soil solution collection sites in the reference watershed (MUN). Precipitation and throughfall collectors consisted of a 4-L polyethylene bottle containing a 15-cm diameter funnel with Teflon wool inserted in the neck to act as a coarse filter.

In situ soil solutions were collected from three sites in the clearcut (KJE) and reference (MUN) watersheds using zero-tension lysimeters. Lysimeters consisted of open-topped polyethylene containers (15 by 10 by 4 cm; L × W × D) filled with acid-washed

quartz sand (Driscoll and others 1988). Lysimeters were placed in duplicate at the 20- and 40-cm depths along with a single collector at the 60-cm depth. Lysimeters were installed by tunneling from below and from the side of the excavated soil pit to the desired depth. This installation technique minimizes disturbance to the soil fabric and rooting system overlying the lysimeter. Lysimeters were installed one year before soil solutions were collected for chemical analysis. This equilibration period minimizes the potential for artifacts due to disturbance from lysimeter installation (Johnson and others 1995).

Concentrations of stream-water nutrients from watersheds receiving various combinations of forest harvest practices (e.g., clearcutting and burning) were compared to reference watersheds having no disturbance (fig. 2). Additionally, samples were collected along the main channel of the North Fork to determine the magnitude and persistence of the cumulative effects of timber harvest practices within the larger watershed. Grab samples were collected biweekly (rainy season) to monthly (nonrainy season) at 13 sites commencing in March 1991 and continuing through June 1996. In addition to the regular grab-sampling protocol, automatic pumping samplers were used to intensively collect water samples during storm events from the clearcut (KJE) and reference (MUN) watersheds. The autosamplers were programmed to collect storm samples using a variable probability (SALT) random sampling procedure (Thomas 1985, 1989). All stream-water samples were

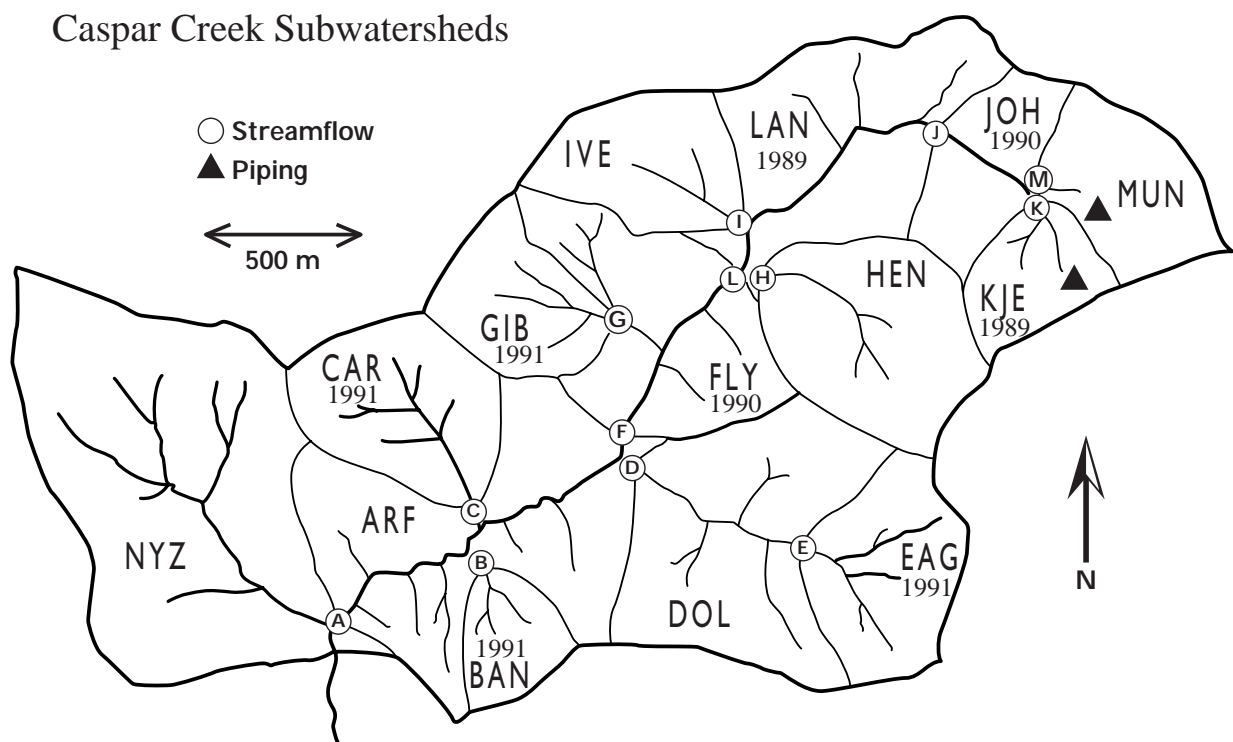

Figure 2—Site map indicating the location of the individual subwatersheds within the North Fork of Caspar Creek watershed. Letters indicate location of stream-water sampling sites; triangles, the location of piping water samples; and years, the year in which felling activity was completed in clearcut watersheds.

collected by the USDA Forest Service Caspar Creek Research Team. Before chemical analyses, all solutions were filtered through a 0.2- μm membrane filter. Ammonium and nitrate were determined by ion chromatography. Data for 10 additional solutes are given in the final report (Dahlgren 1998). During the 1994-1995 water year, water samples from three storm events were bulked to provide approximately a 20-L sample for isolation of the suspended sediment fraction ($>0.4\ \mu\text{m}$). Carbon and nitrogen concentrations were determined by dry combustion using a C/N analyzer.

Nutrient Analysis in Biomass

Nutrient pools in biomass were determined for the regenerating redwood spouts in the clearcut watershed (KJE) and for the second-growth redwood/Douglas-fir stand in the reference watershed (MUN). Ten randomly selected 10-m by 10-m plots were sampled within the clearcut watershed in November 1995 to quantify total aboveground biomass production 6 years after completion of harvest. All shoots and their diameters were recorded within each plot for the stump-sprouting redwoods. To develop allometric relationships for the redwood sprouts, 10 individual stems spanning the range of diameter classes (0.76–7.6 cm) were destructively sampled. Biomass from each sprout was divided into foliage, twigs ($<2\ \text{mm}$), and branches/stems ($>2\ \text{mm}$). The mass of each category was recorded after drying at 70 °C.

Nutrient pools in the second-growth stand of the reference watershed (MUN) were estimated by sampling various biomass components from four replicates each of redwood and Douglas-fir. Foliage and branch samples were obtained from the mid-point of the upper, middle and lower one-third portions of each tree canopy by climbing the tree. For each tree, all branch and foliage samples at each canopy position were separately processed and chemically analyzed. Individual root samples from each tree were obtained by excavating at the base of each tree; samples were collected one meter away from the base of the tree in the Oi/Oe and A horizons. Stemwood and bark were collected by coring individual trees at breast height (1.4 m).

Carbon and nitrogen concentrations were determined on ground samples ($<250\ \mu\text{m}$) by dry combustion using a C/N analyzer. Nitrogen recovery was 95.2 ± 2.3 percent based on analysis of National Bureau of Standard's reference materials. Nutrient pools in biomass of the redwood/Douglas-fir forest were determined from stand density, allometric relationships obtained from Gholz and others (1979), and nutrient concentrations determined from the preceding analyses. Because no allometric relationships were available for aboveground biomass in redwood, we estimated the redwood biomass amounts using the Douglas-fir allometric relationships. This extrapolation introduces a potential error into the estimate for the redwood aboveground nutrients; however, this error will most likely be on the order of <20 percent. Root biomass for the second-growth forest and stump sprouts was estimated from the data of Ziemer and Lewis³ obtained from comparable forest stands in northern California.

³ Unpublished data from Ziemer and Lewis on file at USDA Forest Service, Redwood Sciences Laboratory, Arcata, CA 95521.

Results and Discussion

Soils

Soils provide ecosystem resiliency after perturbations owing, in large part, to their capacity to provide stored nutrients for regenerating vegetation. The effects of clearcut harvesting on the quantity and distribution of organic carbon and nitrogen in soils were examined by comparing soils in the reference watershed (MUN) to those in the clearcut watershed (KJE) 3 years after the harvest. An important difference between soils in the two watersheds was the loss of the majority of the litter layer (Oi/Oe horizon) from the clearcut watershed. An Oi/Oe layer with a thickness of 1-3 cm was found on all soils within the reference watershed. The loss of the litter layer after harvest was due to microbial decomposition and mixing of the litter layer with the mineral soil during logging operations. The litter layer plays an important role in forest ecosystems by protecting the mineral soil from erosion, storing nutrients and water, and acting as mulch to reduce temperature fluctuations and evaporative water loss.

Nutrient pools contained within the primary rooting zone (upper 100-120 cm) were determined as a function of soil horizon for the reference and clearcut watersheds (*fig. 3*). In spite of the loss of the litter layer from soils in the clearcut watershed, there were no statistical differences ($p < 0.05$) in organic carbon or nitrogen pools between the clearcut and reference watersheds. The soils store a very large pool of organic carbon ($\sim 170\ \text{Mg ha}^{-1}$), primarily in the A and AB horizons (the upper 30 cm). The loss of the Oi/Oe horizon from the clearcut watershed appears to be compensated for by an increase in organic carbon in the A horizon. This may reflect the mixing of the litter layer with the mineral soil during harvesting operations. The soils similarly store large concentrations of nitrogen ($>9\ \text{Mg ha}^{-1}$); however, this nitrogen pool is not readily available to the vegetation until mineralization releases the nitrogen from the soil organic matter (*fig. 1*). Because the soil N pool is so large ($10,000\ \text{kg ha}^{-1}$), even an appreciable decrease, such as $100\ \text{kg ha}^{-1}$, after harvest cannot be accurately determined by standard solid-phase analysis, especially given the high spatial variability. Therefore, analysis of solid-phase soil properties is not a sensitive method for determining changes in nutrient cycling processes due to disturbance.

Ecosystem Waterflows

Analysis of ecosystem waterflows is a far more powerful approach than solid-phase soil analysis for detecting treatment effects after ecosystem disturbance because aqueous transport is a primary mechanism for the redistribution of nutrients within an ecosystem. Because ecosystem waterflows provide information about current-day nutrient transport processes, their composition is very sensitive to changes due to disturbance. The nutrient concentrations were examined along the hydrologic cycle within the second-growth redwood/Douglas-fir and clearcut ecosystems to examine changes in nutrient cycling (*fig. 4*). The precipitation had trace inputs of N ($\text{NH}_4 = 0.8\ \mu\text{M}$ and $\text{NO}_3 = 1.0\ \mu\text{M}$) that were not appreciably altered by canopy processes. Concentrations of NH_4 in soil solutions were

very low (<3 μM) and showed no difference between the reference and clearcut soils. Nitrate concentrations were also low; however, nitrate concentrations were significantly greater throughout the entire soil profile of the clearcut watershed. Enhanced nitrogen mineralization rates coupled with reduced uptake were responsible for the increased nitrate mobility after the harvest (fig. 1). Soil solution nitrate concentrations in this study were very low compared to values commonly exceeding 200 μM after clearcutting of northern hardwood forests in the Hubbard Brook Ecological Forest in New Hampshire (Dahlgren and Driscoll 1994). Within the soil profile from the clearcut, the concentration of nitrate decreases appreciably with depth because of nitrogen uptake by the stump-

sprouting redwoods. In the absence of this nitrogen uptake, nitrogen losses to stream water would probably be much higher. Concentrations of nitrate were higher in the stream water than at the 60-cm depth in the soil profile in both watersheds. The higher nitrate concentrations in the stream water most likely result from changes in the hydrologic flowpath during storm events. Our data suggest that water from the upper soil horizons (0- to 30-cm depth) is preferentially routed to the streams during storm events owing to the low saturated hydraulic conductivities associated with the clay-rich B horizons that begin at a depth of about 30 cm. Mean concentrations of nitrate in stream water were very similar to those occurring in soil solutions at the 20- and 40-cm depth (fig. 4).

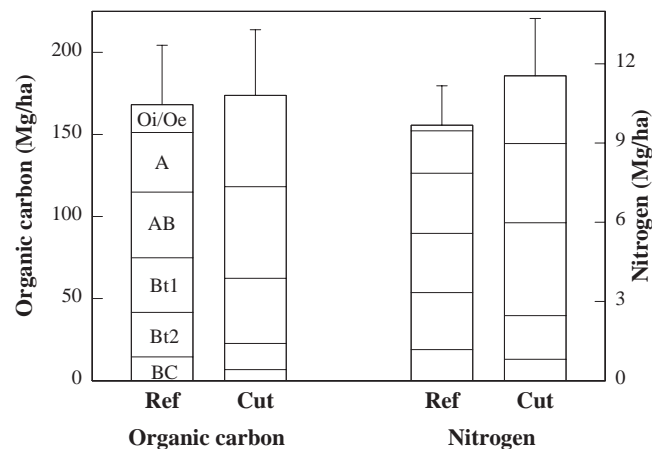

Figure 3—Carbon and nitrogen pools in reference watershed (MUN) and clearcut watershed (KJE) 3 years after the harvest. The individual segments of each bar indicate the nutrient amount contained within that individual soil horizon (no Oi/Oe in clearcut). Error bar indicates the standard error of the mean.

Stream-Water Nitrate

Watershed-scale manipulations are a powerful approach for studying the cumulative effects of forest management practices on nutrient cycling processes. Watershed manipulation studies use a paired watershed approach in which two watersheds with similar characteristics are employed. In this study, stream-water chemistry from the reference watershed (MUN) is compared to that from clearcut (KJE) and clearcut/burned (EAG) watersheds to examine the effects of harvesting practices on nutrient cycling (fig. 2). The export of nutrients in stream water is often one of the primary processes responsible for nutrient losses from forested ecosystems. Monitoring of stream-water chemistry began in the KJE watershed approximately 1.25 years (in March 1991) after completion of felling operations and in the EAG watershed immediately after harvest and burning activities.

Nitrate concentrations in stream water from the reference watershed were generally less than our detection limits of 0.4 μM ; however, concentrations exceeding 10 μM were measured during two storm events in the 1995-1996 water year (fig. 5). In contrast, nitrate concentrations in the harvested watersheds ranged between 10 and 70 μM during storm events. Baseflow nitrate concentrations in the clearcut watershed were also low, often below detection limits (0.4 μM). It appears that nitrate concentrations showed a progressive decrease in peak concentrations after the clearcut (1991 to 1994), with the exception of increased concentrations during storm events in the 1995-1996 water year. The increased nitrate concentrations during the 1995-1996 water year were observed in both the clearcut and reference watersheds, suggesting that the increase was not solely due to the disturbance associated with harvest practices.

Increased nitrate concentration in stream water after clearcutting is a common observation; however, the magnitude of nitrate leaching varies appreciably between ecosystems. For example, maximum nitrate concentrations in stream water after clearcutting of northern hardwood forests in the White Mountains of New Hampshire were 500 μM (Dahlgren and Driscoll 1994), nearly an order of magnitude greater than those observed in this study. We believe that the rapid immobilization of nitrogen by the stump sprouting redwood biomass is an important factor limiting the leaching losses of nitrate in this redwood/Douglas-fir ecosystem.

The maximum concentrations of nitrate often occur in the

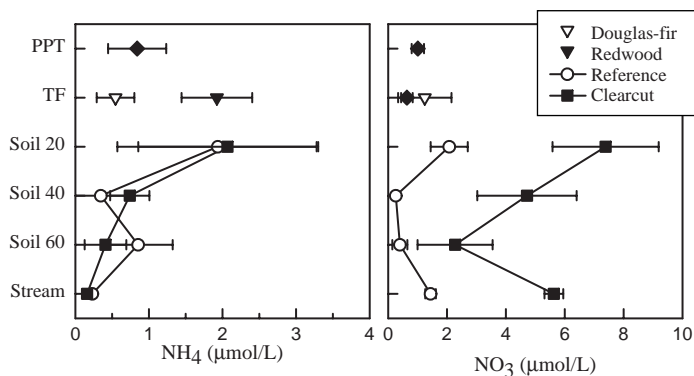

Figure 4—Mean \pm standard deviation for ammonium and nitrate in precipitation (PPT); canopy throughfall (TF); soil solutions at 20-, 40-, and 60-cm depths; and stream water for the period October 1993 to June 1996 in the clearcut (KJE) and reference (MUN) watersheds.

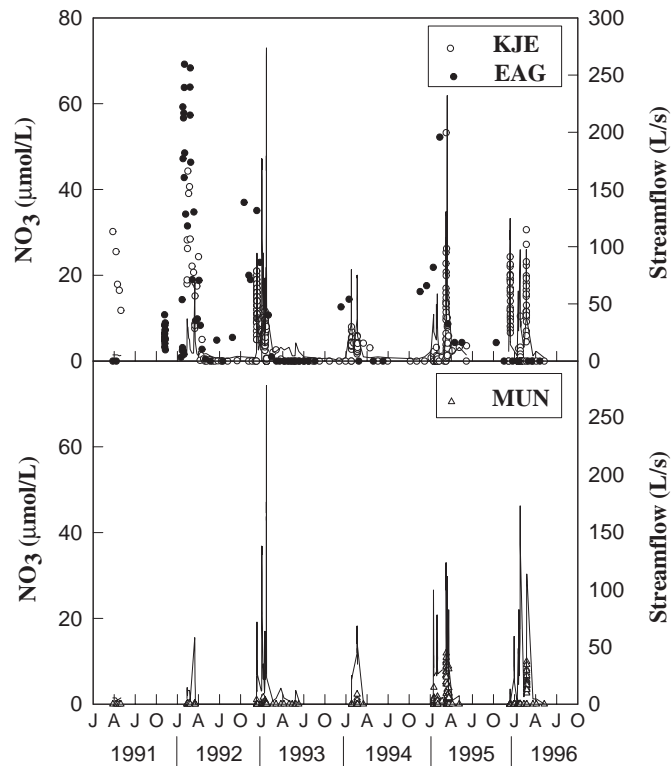

Figure 5—Stream-water nitrate concentrations and stream flow in the clearcut (KJE), clearcut and burned (EAG; no stream flow shown), and reference (MUN) watersheds of the North Fork, Caspar Creek.

second year after clearcutting (Martin and others 1986). This results from enhanced immobilization of nitrogen during the first year as microorganisms begin to decompose woody litter, with high C/N ratios, that was added to the soil organic matter pool as slash during the harvest. Because we missed the January 1990 to March 1991 monitoring period in the KJE watershed, we cannot specifically determine the timing of peak nitrate concentrations after harvest in this watershed. However, nitrate concentrations in stream water peaked in the EAG watershed in the water year immediately after harvest and burning. Removal of woody biomass by burning may result in less microbial immobilization and a more rapid release of mineral nitrogen in this watershed.

Maximum nitrate concentrations occur during high-discharge storm events and drop to low levels during baseflow (fig. 5). We interpret these data to indicate that changing hydrologic flowpaths during storm events result in the delivery of high-nitrate waters to the stream during peak discharge. Data on soil solution indicate that the highest nitrate concentrations occur within the upper soil horizons (fig. 4). The soils within the watershed have a thick, clay-enriched horizon beginning at a depth of approximately 30 cm. This horizon contains >40 percent clay, substantially reducing the hydraulic conductivity that results in temporary saturation above this layer. Given the steep slopes within the watershed, this

saturated layer may move laterally downslope, transporting nutrients from within the nutrient-rich rooting zone (upper 30 cm). This water enters the stream as subsurface lateral flow (Keppeler and Brown, these proceedings) contributing to maximum stream-water nitrate concentrations during peak discharge. The lateral flow of water above the clay-rich horizon and through macropores (e.g., root channels and soil pipes) was observed repeatedly on roadcuts within the Caspar Creek drainage supporting this mechanism.

Nutrient Input/Output Budgets

Although nutrient concentrations in ecosystem waterflows provide information on processes regulating nutrient concentrations in stream water, the most important consideration from an ecosystem sustainability perspective is the nutrient flux ($\text{kg ha}^{-1} \text{yr}^{-1}$) associated with atmospheric deposition and streamflow. Fluxes in stream-water nutrients were calculated by combining stream discharge (L s^{-1}) with nutrient concentrations (mg L^{-1}). Because the water yields of clearcut and reference watersheds differ appreciably (Keppeler, these proceedings; Ziemer, these proceedings), what appear to be small differences in stream-water nutrient concentrations result in much larger differences in nutrient fluxes.

Nitrogen fluxes in precipitation are shown for the 5 water years of the study in table 1. The precipitation fluxes are regulated to a large degree by the precipitation amount for a given year. Precipitation amounts from nearby Fort Bragg during the study period ranged from a low of 78 cm during the 1993-1994 water year to a high of 148 cm during the 1994-1995 water year. Nitrogen fluxes in bulk precipitation were very low, ranging between 0.1 and 0.4 $\text{kg N ha}^{-1} \text{yr}^{-1}$ during the study period. Actual nitrogen inputs to this ecosystem may be somewhat higher because the forest canopy has a much higher efficiency of capturing atmospheric gases, aerosols, and particulate matter than the funnel used to collect the bulk precipitation. In contrast, the capture efficiency of the clearcut watershed would be greatly attenuated by the removal of the canopy.

Nitrogen fluxes in stream water were substantially higher for the clearcut watershed than for the reference watershed (table 1). The maximum nitrogen flux in the clearcut watershed was 1.85 $\text{kg N ha}^{-1} \text{yr}^{-1}$ in the 1991-1992 water year. Nitrogen fluxes decreased over time to 0.15 $\text{kg N ha}^{-1} \text{yr}^{-1}$ in the 1995-1996 water year (the 7th water year following harvest). In contrast, nitrogen fluxes were low (<0.10 $\text{kg N ha}^{-1} \text{yr}^{-1}$) in the reference watershed. The increased

Table 1—Nitrogen fluxes contained in precipitation and stream water from the reference (MUN) and clearcut (KJE) watersheds for the 5-year study period.

Water year	Precipitation	Stream water	
		Reference	Clearcut
		----- kg ha^{-1} -----	
1991-92	0.22	<0.01	1.85
1992-93	0.40	<0.01	1.08
1993-94	0.36	<0.01	0.19
1994-95	0.15	0.08	0.37
1995-96	0.10	0.04	0.15

nitrogen flux in stream water after harvest results from the combination of increased stream-water nitrate concentrations and an increase in water yield due to reduced evapotranspiration and interception of water by the canopy. Nitrogen fluxes return to background levels when the immobilization capacity of the regenerating vegetation approaches the rate of nitrogen mineralization. The recovery period of 5-7 years is consistent with the findings of other studies examining the effects of clearcutting on stream-water nutrient fluxes (Dahlgren and Driscoll 1994, Hornbeck and others 1987, Martin and others 1986).

Cumulative Effects in Stream-Water Nitrate Concentrations

The cumulative effects of timber harvest operations (i.e., the distance to which a harvesting effect is observed downstream from the harvested watershed) is a very important attribute of watershed biogeochemistry. Some impacts may be observed far downstream of the actual disturbance, whereas other impacts may not be detectable downstream of a disturbance. *Figure 6* shows mean stream-water nitrate concentrations in nondisturbed reference watersheds (HEN, IVE, and MUN), harvested watersheds (BAN, CAR, EAG, GIB, and KJE), sampling points along the main stem that combine water from reference and harvested watersheds (DOL, FLY, LAN, and JOH), and the main stem just before it exits the experimental watershed (ARF).

The reference watersheds showed very low concentrations of nitrate with a relatively low standard deviation. Nitrate concentrations in stream water draining the clearcut watersheds showed elevated nitrate concentrations with a mean of about 4 μM

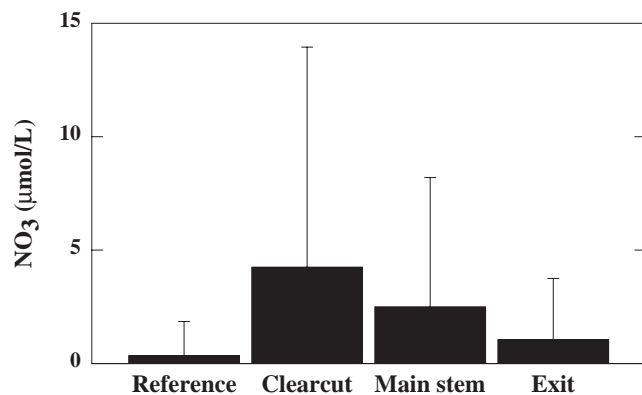

Figure 6—Cumulative effects of nitrate concentrations (mean±standard deviation) in stream waters of the North Fork, Caspar Creek experimental watershed. Data shown are for reference watersheds (HEN, IVE, and MUN), harvested watersheds (BAN, CAR, EAG, GIB, and KJE), locations downstream from harvested watersheds (Main stem; DOL, FLY, LAN, and JOH), and at the exit point (Exit; ARF) of the stream from the experimental watershed.

over the 5-year study period. The high standard deviation associated with harvested watersheds reflects the temporal variability that occurs in nitrate leaching after the harvest. Maximum concentrations of about 70 μM were measured from clearcut watersheds. Also contributing to the large standard deviations are the large fluctuations that occur in nitrate concentrations during storm events because of changing hydrologic flowpaths. Nitrate concentrations decreased at sampling points downstream from the harvested watersheds and reached a mean value of about 1 μM as the stream water exited the experimental watershed. The decrease in nitrate concentrations as the water enters higher-order streams appears to be largely due to dilution with low-nitrate waters entering from nondisturbed portions of the watershed. There may be some attenuation of nitrate concentrations by in-stream immobilization of nitrate by biota; however, the short residence time of water in the watershed provides very little time for biological processes to affect water quality.

Nutrient Pools in Biomass

An inventory of the number and size distribution of stump-sprouting redwoods in watershed KJE was made 6 years after clearcut harvesting. This inventory showed 5020 ± 1970 stems ha⁻¹ (mean ± std. dev.; range = 2600 - 8300) having a DBH of 2.59 ± 0.71 cm (mean ± std. dev.). The DBH of the stump sprouts ranged from <1 to 10 cm. The diameter distribution indicates that the majority (76 percent) of the stems have DBH values ≤ 3 cm with far fewer stems in the larger diameter classes (Dahlgren 1998). Within a cluster of stems surrounding a stump, there were generally 1 to 4 dominant stems with DBH values greater than about 6 cm.

Total carbon storage in the aboveground biomass of the 6-year-old redwood stand was 7.8 Mg ha⁻¹ (*table 2*). On the basis of an average carbon content of about 50 percent for the biomass, there was more than 15 Mg ha⁻¹ of aboveground biomass within the redwood sprouts 6 years after harvest. This rapid accumulation of biomass after harvest is the result of the rapid regrowth associated with regeneration from stump sprouting versus establishment from seed. The large intact rooting system can acquire an abundance of nutrients to support regrowth. Also important in this rapid regrowth is the immobilization of potentially mobile nutrients, such as nitrate, into the aboveground biomass. The accumulation of 70 kg N ha⁻¹ in the aboveground biomass and the retention of 16 kg N ha⁻¹ in the living rooting system greatly attenuate leaching of nitrogen after harvest (*table 1*). Warmer and moister soil conditions combined with higher organic matter concentrations from logging slash after clearcutting result in higher decomposition, mineralization, and leaching (*fig. 1*). Thus, rapid immobilization of nutrients by the aggrading redwood forest will have a strong influence on nutrient dynamics and leaching after harvest in these ecosystems.

Nutrient pools calculated for the second-growth redwood/Douglas-fir stand showed 644 Mg C ha⁻¹ (~1288 Mg ha⁻¹ of biomass) stored in this forest ecosystem that is more than 80 years old (*table 2*). The wood and bark components contain about 86 percent (555.5 Mg ha⁻¹) of the biomass carbon, and only 6.4 percent (41 Mg ha⁻¹) of the biomass carbon pool is found in the belowground root biomass.

Table 2—Carbon and nitrogen pools contained in stump-sprouting redwood 6 years after clearcutting (KJE) and in the second-growth redwood/Douglas-fir stand (MUN).

Biomass component	Carbon		Nitrogen	
	Clearcut	Second-growth	Clearcut	Second-growth
	----- kg ha ⁻¹ -----			
Foliage	1,914	12,400	42.6	269
Branches/redwood stems	5,915	34,900	27.5	95
Wood		488,000		735
Bark		67,500		214
Roots	2,660	41,000	15.6	166
Total	10,489	643,800	85.7	1,479

The biomass contains nearly four times the amount of organic carbon stored in the soil profile (~170 Mg ha⁻¹). There was a total of 1480 kg ha⁻¹ of nitrogen in the redwood and Douglas-fir biomass in this ecosystem (table 2). Only 10 percent (166 kg ha⁻¹) of the nitrogen pool is found in the belowground root biomass. Approximately 64 percent (949 kg ha⁻¹) of the total nitrogen in the biomass is contained within the wood and bark components. Because conventional clearcutting removes only the wood and bark components, it is this 949 kg ha⁻¹ of nitrogen that will be removed from the ecosystem by traditional clearcut harvesting.

Nutrients in Suspended Sediments

The transport of nutrients in suspended sediments can be substantial if steps are not taken to minimize erosion after harvest. We determined the nutrient concentrations of suspended sediment collected from both the clearcut (KJE) and reference (MUN) watersheds in order to provide an estimate of the amount of nitrogen lost from these watersheds as suspended sediment. The nitrogen content of suspended sediment in the reference watershed (4.4 ± 1.9 g N kg⁻¹) was 2.7 times higher than in the clearcut watershed (1.6 ± 0.5 g N kg⁻¹). This difference possibly reflects the origin of the suspended sediment. The soil surface of the reference watershed is covered by a litter layer that would produce a relatively organic-rich sediment. In contrast, the loss of the litter layer from the clearcut watershed results in a soil surface with a lower organic matter concentration. Thus, the difference in the nitrogen content of suspended sediments between the two watersheds probably reflects the contrasting nature of the soil surface in the two watersheds, or different source areas. The source of much of the sediment in KJE was likely from sediments stored in the channel (Lewis, these proceedings).

The suspended sediment load predicted for an unlogged condition in water years 1990-1996 for the entire North Fork Caspar Creek experimental watershed was about 385 kg ha⁻¹ yr⁻¹ before harvest activities (Lewis, personal communication). If the nitrogen content (4.4 g N kg⁻¹) of the suspended sediments from the reference watershed (MUN) is representative of that for the entire watershed

before harvest, 1.7 kg ha⁻¹ yr⁻¹ of nitrogen would be lost from the watershed as suspended sediment. Harvest activities within the entire North Fork experimental watershed resulted in an increase of 345 kg ha⁻¹ yr⁻¹ of suspended sediment (Lewis, personal communication). However, the total nitrogen lost from the clearcut watershed would actually be somewhat lower than that lost from the reference watershed because of the lower nitrogen content associated with suspended sediment from the clearcut watershed (1.6 g N kg⁻¹). Because of the limited data collected in this study and the large temporal variability associated with suspended sediment fluxes over the course of a harvest rotation, it is very difficult to estimate the long-term nitrogen fluxes from these watersheds.

Ecosystem Nitrogen Sustainability

Sustainable forestry is based on the premise of removing essential nutrients at a rate less than or equal to that which can be replenished by natural processes. As shown in the preceding discussion, nitrogen is lost from the ecosystem primarily by biomass removal, suspended sediment, and leaching. Denitrification may also result in nitrogen loss; however, we have no estimates of how much nitrogen may be lost by this mechanism. The primary inputs of nitrogen into the ecosystem are atmospheric deposition and nitrogen fixation, primarily by *Ceanothus*. A nitrogen mass balance was calculated on the basis of estimated nitrogen inputs and outputs over the course of an 80-year harvest rotation (table 3). Regardless of the amount of nitrogen lost in the suspended sediment fraction, there is a net loss of nitrogen from this ecosystem. Nitrogen losses are dominated by biomass removal (~950 kg ha⁻¹), which removes about 60 percent of the nitrogen contained in the biomass. Although the nitrogen loss in the suspended sediment fraction cannot be precisely estimated, it appears to be on the order of 1.0 - 2.0 kg N ha⁻¹ yr⁻¹. These losses greatly exceed the only measured input of about 20 kg N ha⁻¹ in the bulk precipitation. This input/output balance suggests a nonsustainable forest management practice over the long term; however, nitrogen fixers such as *Ceanothus* can contribute appreciable nitrogen inputs into these ecosystems. *Ceanothus thyrsiflorus* (blue-blossom ceanothus) is an aggressive invader after clearcutting, and it has the potential to fix large quantities of nitrogen to replenish the nitrogen deficit imposed by harvesting. Nitrogen fixation rates for *Ceanothus velutinus* in the Oregon Cascades range from 70 to 100 kg N ha⁻¹ yr⁻¹

Table 3—Nitrogen mass balance for clearcut harvest management based on an 80-year harvest rotation. The suspended sediment flux is estimated based on limited data from this study.

Nutrient component	Nitrogen pools and fluxes	
	----- kg ha ⁻¹ -----	
Soil pool	9,500	
Biomass pool	1,480	
Atmospheric deposition flux		+20
Nitrogen fixation flux		+?
Harvest removal flux		-950
Stream-water flux		-10
Suspended sediment flux		-80 to -160

(Binkley and others 1982, Youngberg and Wollum 1976). These data, as well as data reported in the literature (e.g., Swanson and Franklin 1992), suggest that nitrogen fixation by *Ceanothus* may be necessary to maintain the long-term productivity and sustainability of these ecosystems. Additional research appears warranted to determine the importance of *Ceanothus* in the postharvest recovery of the nitrogen budget in this ecosystem.

Conclusions

Clearcut harvesting of this redwood/Douglas-fir ecosystem did not result in any short-term detectable decrease in soil carbon and nitrogen pools. Stream-water nitrate concentrations were increased after clearcutting, especially during storm events with high stream-discharge volumes; however, fluxes in stream water were relatively low compared to results from other forest ecosystems. Immobilization of nutrients by the rapid regrowth of redwood stump sprouts appears to make this ecosystem relatively resilient to nutrient loss by leaching after harvest. The elevated nitrate concentration in streams draining clearcut watersheds was substantially decreased at downstream sampling points. By the time the stream left the experimental watershed, nitrate concentrations were near those of the nonperturbed reference watersheds. Removal of nitrogen in the harvested biomass results in an appreciable loss of nitrogen from the ecosystem. These data suggest that nitrogen fixation by *Ceanothus* may be an important nitrogen input that is necessary to maintain the long-term productivity and sustainability of these ecosystems.

Acknowledgments

This research was supported by a grant from the California Department of Forestry and Fire Protection. We acknowledge the valuable guidance and logistical support from E. Keppeler, R. Ziemer, J. Munn, and N. Henry. Field assistance by Z. Yu, J. Holloway, D. Baston, R. Northup, and the entire field staff of the USDA Forest Service/Jackson State Forest Caspar Creek Research Team is greatly appreciated.

References

- Binkley, D.; Cromack K.; Fredriksen, R.L. 1982. **Nitrogen accretion and availability in some snowbrush ecosystems.** *Forest Science* 28: 720-724.
- Dahlgren, R.A. 1998. **Effects of forest harvest on biogeochemical processes in the Caspar Creek Watershed.** Unpublished Draft Final Report prepared for the California Department of Forestry and Fire Protection. Contract No. 8CA17039. Sacramento, CA; 151 p.
- Dahlgren, R.A.; Driscoll, C.T. 1994. **The effects of whole-tree clearcutting on soil processes at the Hubbard Brook Experimental Forest, New Hampshire, USA.** *Plant and Soil* 158: 239-262.
- Driscoll, C.T.; Fuller, R.D.; Simone, D.M. 1988. **Longitudinal variations in trace metal concentrations in a northern forested ecosystem.** *Journal of Environmental Quality* 17: 101-107.
- Gholz, H.L.; Grier, C.C.; Campbell, A.G.; Brown, A.T. 1979. **Equations for estimating biomass and leaf area of plants in the Pacific Northwest.** Research Paper 41. Corvallis, OR: Forest Research Laboratory, Oregon State University; 37 p.
- Hornbeck, J.W.; Martin, C.W.; Pierce, R.S.; Bormann, F.H.; Likens, G.E.; Eaton, J.S. 1987. **The northern hardwood forest ecosystem: ten years of recovery from clearcutting.** Res. Paper NE-RP-596. Broomall, PA: Northeastern Forest Experiment Station, Forest Service, U.S. Department of Agriculture; 30 p.
- Johnson, D.W.; West, D.C.; Todd, D.E.; Mann, L.K. 1982. **Effects of sawlog vs. whole-tree harvesting on the nitrogen, phosphorus, potassium, and calcium budgets of an upland mixed oak forest.** *Soil Science Society of America Journal* 46: 1304-1309.
- Johnson, D.W.; Kelly, J.M.; Swank, W.T.; Cole, D.W.; Van Miegroet, H.; Hornbeck, J.W.; Pierce, R.S.; Van Lear, D. 1988. **The effects of leaching and whole-tree harvesting on cation budgets of several forests.** *Journal of Environmental Quality* 17: 418-424.
- Johnson, D.W.; Walker, R.F.; Ball, J.T. 1995. **Lessons from lysimeters – soil N release from disturbance compromises controlled environment study.** *Ecological Applications* 5: 395-400.
- Keppeler, E.T.; Ziemer, R.R. 1990. **Logging effects on streamflow: water yield and summer low flows at Caspar Creek in Northwestern California.** *Water Resources Research* 26: 1669-1679.
- Krammes, J.S.; Burns, D.M. 1973. **Road construction on Caspar Creek watersheds ... a 10-year progress report.** Res. Paper PSW-93. Berkeley, CA: Pacific Southwest Forest and Range Experiment Station, Forest Service, U.S. Department of Agriculture; 10 p.
- Likens, G.E.; Bormann, F.H.; Johnson, N.M.; Fisher, D.W.; Pierce, R.S. 1970. **Effects of forest cutting and herbicide treatment on nutrient budgets in the Hubbard Brook watershed-ecosystem.** *Ecological Monographs* 40: 23-47.
- Lindberg, S.E.; Lovett, G.M.; Richter, D.D.; Johnson, D.W. 1986. **Atmospheric deposition and canopy interactions of major ions in a forest.** *Science* 231: 141-145.
- Martin, C.W.; Pierce, R.S.; Likens, G.E.; Bormann, F.H. 1986. **Clearcutting affects stream chemistry in the White Mountains of New Hampshire.** Res. Pap. NE-579. Broomall, PA: Northeastern Forest Experiment Station, Forest Service, U.S. Department of Agriculture; 12 p.
- Rice, R.M.; Tilley, F.B.; Datzman, P.A. 1979. **A watershed's response to logging and roads: South Fork of Caspar Creek, California, 1967-1976.** Res. Paper PSW-146. Berkeley, CA: Pacific Southwest Forest and Range Experiment Station, Forest Service, U.S. Department of Agriculture; 12 p.
- Soil Survey Staff. 1984. **Procedures for collecting soil samples and methods of analysis for soil survey.** Soil Survey Investigations Report No. 1. Washington, DC: Soil Conservation Service, U.S. Department of Agriculture.
- Swanson, F.J.; Franklin, J.F. 1992. **New forestry principles from ecosystem analysis of Pacific Northwest forests.** *Ecological Applications* 2: 262-274.
- Thomas, R.B. 1985. **Estimating total suspended sediment yield with probability sampling.** *Water Resources Research* 21: 1381-1388.
- Thomas, R.B. 1989. **Piecewise SALT sampling for estimating suspended sediment yields.** Gen. Tech. Rep. PSW-83. Berkeley, CA: Pacific Southwest Forest and Range Experiment Station, Forest Service, U.S. Department of Agriculture; 11 p.
- Thomas, R.B. 1990. **Problems in determining the return of a watershed to pretreatment conditions: techniques applied to a study at Caspar Creek, California.** *Water Resources Research* 26: 2079-2087.
- Tilley, F.B.; Rice, R.M. 1977. **Caspar Creek watershed study—a current status report.** State Forest Notes 66. Sacramento, CA: State of California Department of Forestry; 15 p.
- Wright, K.A.; Sendek, K.H.; Rice, R.M.; Thomas, R.B. 1990. **Logging effects on streamflow: storm runoff at Caspar Creek in northwestern California.** *Water Resources Research* 26: 1657-1667.
- Youngberg, C.T.; Wollum, A.G. 1976. **Nitrogen accretion in developing *Ceanothus velutinus* stands.** *Soil Science Society of America Journal* 40: 109-112.
- Ziemer, R.R. 1981. **Storm flow response to road building and partial cutting in small streams of northern California.** *Water Resources Research* 17: 907-917.

Evaluating the Impacts of Logging Activities on Erosion and Suspended Sediment Transport in the Caspar Creek Watersheds¹

Jack Lewis²

Abstract: *Suspended sediment has been sampled at both the North and South Fork weirs of Caspar Creek in northwestern California since 1963, and at 13 tributary locations in the North Fork since 1986. The North Fork gaging station (NFC) was used as a control to evaluate the effects of logging in the South Fork, in the 1970's, on annual sediment loads. In the most conservative treatment of the data, suspended loads increased by 212 percent over the total predicted for a 6-yr period commencing with the onset of logging. When the roles of the watersheds were reversed and the same analysis repeated to evaluate harvesting in the North Fork under California Forest Practice Rules in the 1990's, no significant increase was found at NFC in either annual suspended or bed load.*

With the advent of automatic pumping samplers, we were able to sample sediment concentration much more frequently in the 1980's. This allowed storm event loads from control watersheds in the North Fork to be used in a new regression analysis for NFC. According to this more sensitive analysis, for the 7-yr period commencing with the onset of logging, the sum of the suspended storm loads at NFC was 89 percent higher than that predicted for the undisturbed condition. The much greater increase after logging in the South Fork is too great to be explained by differences in sampling methods and in water years, and appears to be the result of differences in road alignment, yarding methods, and stream protection zones.

Similar analyses of storm event loads for each of the treated subwatersheds in the North Fork suggested increased suspended loads in all but one of the tributaries, but effects were relatively small or absent at the main stem locations. Of watersheds with less than 50 percent cut, only one showed a highly significant increase. The greater increase in sediment at NFC, compared to other main-stem stations, is largely explained by a 3,600-m³ landslide that occurred in 1995 in a subwatershed that drains into the main stem just above NFC. Differences among tributary responses can be explained in terms of channel conditions.

Analysis of an aggregated model simultaneously fit to all of the data shows that sediment load increases are correlated with flow increases after logging. Field evidence suggests that the increased flows, accompanied by soil disruption and intense burning, accelerated erosion of unbuffered stream banks and channel headward expansion. Windthrow along buffered streams also appears to be important as a source of both woody debris and sediment. All roads in the North Fork are located on upper slopes and do not appear to be a significant source of sediment reaching the channels.

The aggregated model permitted evaluation of certain types of cumulative effects. Effects of multiple disturbances on suspended loads were approximately additive and, with one exception, downstream changes were no greater than would have been expected from the proportion of area disturbed. A tendency for main-stem channels to yield higher unit-area suspended loads was also detected, but after logging this was no longer the case in the North Fork of Caspar Creek.

Soil erosion and mass movement play major roles in shaping the landscapes that surround us. These processes complement those that build mountains and soils, resulting in landforms such as valleys, ridges, stream channels, and flood plains. Human activities that change the balances between these processes can have consequences that are detrimental to humans and the ecosystems we depend on. Human activities often lead to an acceleration of soil movement, net soil losses from hillslopes, and increases in sediment transport and deposition in stream channels. When soil erosion and mass movement directly damage roads, bridges, and buildings, the costs are immediate and obvious. Direct effects on ecosystem function and site productivity are also serious issues in many areas. Indirect impacts on downstream water quality and stream channel morphology, however, are often of greater concern.

Sediment-laden water supplies reduce the capacity of storage reservoirs and may require additional treatment to render the water drinkable. Sediment in irrigation water shortens the life of pumps and reduces soil infiltration capacity. Water quality is also an important issue for recreational water users and tourism.

Impacts of water quality on fish and aquatic organisms have motivated much of the research being presented at this conference. High sediment concentrations can damage the gills of salmonids and macroinvertebrates (Bozek and Young 1994, Newcombe and MacDonald 1991). High turbidity can impair the ability of fish to locate food (Gregory and Northcote 1993) and can reduce the depth at which photosynthesis can take place. However, suspended sediment is not always detrimental to fish, and indexes based on duration and concentration are unrealistically simplistic (Gregory and others 1993). Turbidity, can, for example, provide cover from predators (Gregory 1993).

If stream channels cannot transport all the sediment delivered from hillslopes, they will aggrade, resulting in increased risks for overbank flooding and bank erosion. It was this sort of risk, threatening a redwood grove containing the world's tallest tree, that motivated the expansion of Redwood National Park in 1978 (U.S. Department of Interior 1981). Accelerated delivery of sediment to streams can result in the filling of pools (Lisle and Hilton 1992), and channel widening and shallowing. Hence, fish rearing habitat may be lost, and stream temperatures often increase. Excessive filling in spawning areas can block the emergence of fry and bury substrates that support prey organisms. Settling and infiltration of fine sediments into spawning gravels reduces the transport of oxygen to incubating eggs (Lisle 1989) and inhibits the removal of waste products that accumulate as embryos develop (Meehan 1974). If aggradation is sufficient to locally eliminate

¹ An abbreviated version of this paper was presented at the Conference on Coastal Watersheds: The Caspar Creek Story, May 6, 1998, Ukiah, California.

² Mathematical Statistician, Pacific Southwest Research Station, USDA Forest Service, 1700 Bayview Drive, Arcata, CA 95521.

surface flows during the dry season, fish can lose access to good upstream habitat or become trapped in inhospitable environments.

How Do Harvest Practices Affect Sediment Movement?

Figure 1 displays some of the mechanisms linking harvest activities with in-stream sediment transport. It is impossible to show all the potential interactions in only two dimensions, but the figure does hint at the complexity of controls on sediment movement. Timber harvest activities can accelerate erosion primarily through felling, yarding, skidding, building and using roads and landings, and burning.

Felling

Removing trees reduces evapotranspiration and rainfall interception, thus resulting in wetter soils (Keppeler and others 1994, Ziemer 1968). Loss of root strength and wetter soils can decrease slope stability (O’Loughlin and Ziemer 1982, Ziemer 1981). Trees near

clearcut edges face increased wind exposure and become more susceptible to blowdown (Reid and Hilton, these proceedings), disrupting soils if trees become uprooted. Addition of woody debris to channels can cause scouring of the banks and channel, but also can reduce sediment transport by increasing channel roughness and trapping sediment (Lisle and Napolitano, these proceedings). The effects of felling upon erosion can be altered by controlling the quantity and the spatial and temporal patterns of cutting.

Yarding and Skidding

Heavy equipment compacts soils, decreasing infiltration and percolation rates and increasing surface water. If vegetation and duff are removed, the underlying soils become vulnerable to surface erosion. The pattern of yarding and skidding can alter drainage paths and redirect water onto areas that may be more likely to erode than naturally evolved channels. Damage from yarding and skidding is controlled primarily by the type of equipment, the care exercised by the equipment operator, timing of operations, landing location, and yarding direction.

Roads and Landings

Roads and landings have similar, but usually more pronounced, impacts as yarding and skidding, and their presence can greatly increase landslide risk. Compaction of the road bed can impede subsurface drainage from upslope areas, resulting in increased pore water pressures (Keppeler and Brown, these proceedings). Road cuts and fills are vulnerable to accelerated runoff and surface erosion, and are particularly vulnerable to slumping, especially on steep slopes or if the fill or sidecast material has not been properly compacted. Although roads and landings may be only a small part of the total forest area, they are responsible for a disproportionate amount of the total erosion (McCashion and Rice 1983, Swanson and Dyrness 1975), often more than half. The erosional impact of roads and landings can be managed through road alignment, design and construction, drainage systems, type and timing of traffic, and maintenance.

Burning

Burning can increase erodibility by creating bare ground, and hot burns can delay revegetation by killing sprouting vegetation. In some cases, burning can accelerate revegetation by releasing or scarifying seeds and preparing a seed bed. Burning in areas with sandy soils can create water-repellent soils and increase surface runoff (DeBano 1979). The effect of burning on erosion depends primarily on the temperature of the burn, soil cover, and soil and vegetation types. Soil moisture, wind, air temperature, humidity, slope steepness, and fuel abundance and distribution are the major factors affecting burn temperatures.

Site Factors

Some sites are particularly vulnerable to mass wasting, and these sites, while occupying a small part of the landscape, have been found to be responsible for a large proportion of the total erosion in

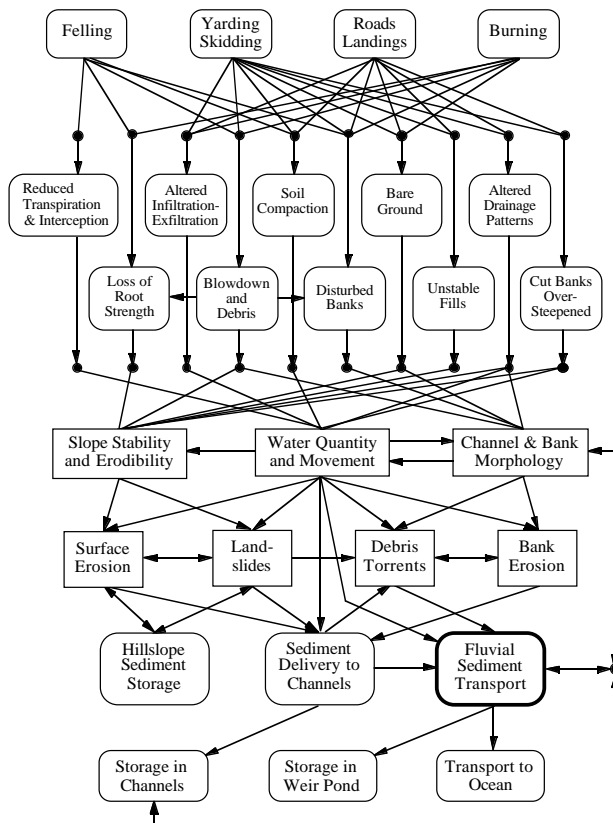

Figure 1—Conceptual diagram showing the major pathways through which logging activities influence fluvial sediment transport.

northwestern California (Dodge and others 1976, Rice and Datzman 1981). In the Critical Sites Erosion Study, an evaluation of 157 mass failure sites ($>153 \text{ m}^3$) and 326 randomly selected control sites from logged areas in northwestern California, Durgin and others (1989) concluded that management and site factors played an equal role in road failures. In contrast, management factors were secondary to site factors on hillslopes. The primary site factors associated with mass failures were steep slopes, noncohesive soils and fill materials, and incompetent underlying regolith. Most failures were associated with the concentration of subsurface water, as evidenced by perennial seeps, poorly drained soils, phreatic vegetation, and locations in swales, inner gorges, and lower slope positions. Previous slope failures were also evident at many of the sites. The primary management factors associated with mass failures were steep or overloaded fill slopes, steep cut banks, and inadequate maintenance of roads and drainage systems. A field procedure for estimating the probability of mass failure was also developed (Lewis and Rice 1990, Rice and Lewis 1991) from the Critical Sites Erosion Study.

Connecting Forest Practices with Water Quality

It is often difficult to identify the causes of erosion. Factors such as increased soil water or reduced root strength are not directly observable. Landslides are normal, stochastic, geomorphic events in many undisturbed areas. Therefore, it may be impossible to show that a landslide in a logged area would not have occurred had the area been treated differently.

There is usually a great deal of uncertainty in determining when and how much sediment from an erosion feature was delivered to a stream channel. And it is even more difficult to determine the origin of suspended sediment that has been measured at a gaging station.

Hence, many studies are correlative and rely on statistics to identify relations between disturbance and water quality. In environmental research, it is difficult to execute an experimental design that permits wide inference. The best designs require randomly assigning the treatments of interest to a large number of similar experimental units. The random assignment reduces the likelihood of associations between treatments and characteristics that might affect the response of some subset of experimental units. When studying a highly variable response such as sediment transport, large sample sizes are needed to detect changes even when the changes are substantial.

When the experimental unit is a watershed, it is usually impractical to randomly assign treatments or monitor a large number of watersheds. Instead, we use watersheds with similar physical characteristics and subject to similar environmental influences, and we repeat measurements before and after treatments are applied, maintaining at least one watershed as an untreated control throughout the study. If the relationship between measurements in the treated and control watersheds changes after treatment, then we can reason that the change is probably due to the treatment, unless some chance occurrence (unrelated to the treatments) affected only one of the watersheds. In reality, we have little control over such chance occurrences. For example, there is no guarantee that rainfall intensities will be uniform over the entire study area.

Such a paired-watershed design can provide a basis for concluding whether a change occurred (Chow 1960, Wilson 1978) and can be used to estimate the magnitude of changes. If chance occurrences can be eliminated, effects can be attributed to the *overall* treatment. If multiple watersheds are included in the design, it may be useful to relate the magnitude of response to disturbances such as proportion of area logged, burned, compacted by tractors, etc. But, without additional evidence, nothing can be concluded about specific causative mechanisms. Conclusions should be *consistent* with the statistical evidence, but cause and effect must be inferred non-statistically, by relating the results to concurrent studies of other responses and physical processes, field observations, and similar observations made elsewhere by others.

Study Area

The Caspar Creek Experimental Watersheds are located about 7 km from the Pacific Ocean in the Jackson Demonstration State Forest, Mendocino County, California (Preface, fig. 1, these proceedings). Until the 1970's, both the 424-ha South Fork and 473-ha North Fork watersheds were covered by second-growth redwood forests, originally logged between 1860 and 1904. Both watersheds are underlain by sandstones and shales of the Franciscan assemblage. Rainfall averages about $1,200 \text{ mm yr}^{-1}$, 90 percent of which falls during October through April, and snow is rare. The location, topography, soils, climate, vegetation, and land use history are described in detail by Henry (these proceedings). The geology and geomorphology are described by Cafferata and Spittler (these proceedings).

Methods

South Fork Treatment

The South Fork of Caspar Creek was roaded in the summer of 1967 and selectively logged in 1971-1973, before Forest Practice Rules were mandated in California by the Z'Berg Nejedly Forest Practice Act of 1973. About 65 percent of the stand volume was removed. In contrast with later logging in the North Fork, 75 percent of the roads in the South Fork were located within 60 m of a stream, all yarding was done by tractor, ground disturbance amounted to 15 percent of the area, and there were no equipment exclusion zones. Details are provided by Henry (these proceedings) and by Rice and others (1979). The North Fork was used as a control watershed to evaluate the effects of logging in the South Fork until the North Fork phase of the study was begun in 1985.

North Fork Treatments

The subwatershed containing units Y and Z (Preface, fig. 2, these proceedings) of the North Fork was logged between December 1985 and April 1986. At the time, this area was thought to have different soils than the remainder of the North Fork, so it was omitted from the study plan that specified logging would begin in 1989. The remainder of the North Fork logging took place between May 1989 and January 1992. Three subwatersheds (HEN, IVE, and MUN) were left uncut throughout the study for use as controls. Henry

(these proceedings) summarizes the logging sequence. Briefly, 48 percent of the North Fork (including units Y and Z) was clearcut, 80 percent of this by cable yarding. Tractor yarding was restricted to upper slopes, as were haul roads, spur roads, and landings. Ground disturbance from new roads, landings, skid trails, and firelines in the North Fork amounted to 3.2 percent of the total area. Streams bearing fish or aquatic habitat were buffered by selectively logged zones 23-60 m in slope width, and heavy equipment was excluded from these areas.

Suspended Sediment and Turbidity Measurements

Accurate suspended sediment load estimation in small rain-dominated watersheds like Caspar Creek depends upon frequent sampling when sediment transport is high. Sediment concentrations are highly variable and inconsistently or poorly correlated with water discharge (Colby 1956, Rieger and Olive 1984). Since the 1960's, manual sampling methods have been standardized by the U.S. Geological Survey. However, adequate records are rare because it is inconvenient to sample at all hours of the night and weekends. Errors of 50-100 percent are probably typical when sampling is based on convenience (Thomas 1988, Walling and Webb 1988).

In the South Fork phase of the study from 1963 to 1975, sediment sampling was semi-automated by rigging bottles in the weir ponds at different heights. These *single-stage samplers* (Inter-Agency Committee on Water Resources 1961) filled at known stages during the rising limb of the hydrograph, but the much lengthier falling limb was sampled using DH-48 depth-integrating hand samplers (Federal Inter-Agency River Basin Committee 1952) and, in most cases, was not well-represented. In 1974 and 1975, the number of DH-48 samples was increased greatly and, in 1976, the single-stage samplers were replaced by pumping samplers. The average number of samples collected was 58 per station per year in 1963-1973 and 196 per station per year in 1974-1985.

During the North Fork phase of the study, in water years 1986-1995, the North Fork weir (NFC), the South Fork weir (SFC) and 13 other locations in the North Fork were gaged for suspended sediment and flow (Preface, fig. 2, these proceedings). Pumping samplers were controlled using programmable calculators and circuit boards that based sampling decisions on real-time stage information (Eads and Boolootian 1985). Sampling times were randomly selected using an algorithm that increased the average sampling rate at higher discharges (Thomas 1985, Thomas 1989). Probability sampling permitted us to estimate sediment loads and the variance of those estimates without bias. We also sent crews out to the watershed 24 hours a day during storm events to replace bottles, check equipment, and take occasional, simultaneous, manual and pumped samples. The average number of samples collected in 1986-1995 was 139 per station per year.

In water year 1996, we began using battery-operated turbidity sensors and programmable data loggers to control the pumping samplers at eight gaging stations, and monitoring was discontinued at the remaining seven stations. Although turbidity is sensitive to particle size, composition, and suspended organics, it is much better

correlated with suspended sediment concentration than is water discharge. A continuous record of turbidity provides temporal detail about sediment transport that is currently impractical to obtain by any other means, while reducing the number of pumped samples needed to reliably estimate sediment loads (Lewis 1996). However, because these turbidity sensors remain in the stream during measurement periods, they are prone to fouling with debris, aquatic organisms, and sediment, so it was still necessary to frequently check the data and clean the optics. The average number of samples collected in 1996 was 49 per station per year.

Suspended Sediment Load Estimation

The basic data unit for analysis was the suspended sediment load measured at a gaging station during a storm event or hydrologic year. Annual loads were estimated only for NFC and SFC and, to facilitate comparisons with the South Fork study, these were computed by Dr. Raymond Rice using the same methods as in an earlier analysis (Rice and others 1979). This involved fitting sediment rating curves by eye, multiplying the volume of flow in each of 19 discharge classes by the fitted suspended sediment concentration at the midpoint of each class, and summing. As technology has improved over the years, our methods of sample selection have improved. Thus, although the computational scheme for estimating annual loads was repeated in both studies, the sampling bias has changed, and caution must be used when comparing the sediment loads from the two studies.

For estimating storm loads in 1986-1995, the concentrations between samples were computed using interpolations relating concentration to either time or stage. Concentration was first adjusted to obtain cross-sectional mean concentrations using regressions based on the paired manual and pumped samples. For those events in which probability sampling was employed, loads and variances were also estimated using appropriate sampling formulae (Thomas 1985, Thomas 1989). However, Monte Carlo simulations (Lewis and others 1998), showed that the interpolation methods were more accurate (lower mean square error). Based on the variance estimates and simulations, the median error of our estimates for storm events was less than 10 percent.

For estimating storm loads in 1996, concentration was predicted using linear regressions, fit to each storm, of concentration on turbidity. This method produced load estimates with the same or better accuracy than before, while substantially reducing the number of samples collected (Lewis 1996). Time or stage interpolation was employed for periods when turbidity information was unavailable.

Total Sediment Load Estimation

The bedload and roughly 40 percent of the suspended load settle in the weir ponds, and thus are not measured at NFC and SFC. The weir ponds are surveyed annually to estimate total sediment load (suspended plus bedload) by summing the pond accumulations and sediment loads measured at the weirs. Pond volumes are converted to mass based on a density of $1,185 \text{ kg m}^{-3}$. In some of the

drier years of record (1972, 1976, 1987, 1991, 1992, and 1994), negative pond accumulations have been recorded. These values may result from settling or measurement errors, but some of the values were too large in magnitude to have resulted from settling alone, so negative values were converted to zero before adding pond accumulations to suspended loads. In the results below, only those that explicitly refer to *total* sediment load include any sediment that settled in the weir ponds.

Erosion Measurements

Starting in 1986, a database of failures exceeding 7.6 m³ (10 yd³) was maintained in the North Fork. This inventory was updated from channel surveys at least once a year. Road and hillslope failures were recorded when they were observed, but an exhaustive search was not conducted. Volume estimates were made using tape measurements of void spaces left by the failures, except in a few cases where more accurate survey methods were used. For each failure, crews recorded void volume, volume remaining at the site (starting in 1993), location, distance to nearest channel, and any association with windthrow, roads, or logging disturbance.

Discrete failures such as those included in the failure database are relatively easy to find and measure. In contrast, surface erosion is difficult to find and sample because it is often dispersed or inconspicuous. To obtain an estimate of dispersed erosion sources, erosion plots were randomly selected and measured in each subwatershed. Rills, gullies, sheet erosion, and mass movements were measured on independent samples of road plots and 0.08-ha circular hillslope plots. Road plots consisted of 1.5-m wide bands oriented perpendicular to the right-of-way, plus any erosion at the nearest downslope diversion structure (water bar, rolling dip, or culvert). A total of 175 hillslope plots and 129 road plots were measured. These data were collected for a sediment delivery study and are summarized in a separate report by Rice (1996).

Analyses and Results

Annual Sediment Loads after Logging the South Fork

Linear regressions between the logarithms of the annual suspended sediment loads at the two weirs were used to characterize (1) the relationship of SFC to NFC before the 1971-1973 logging in the South Fork and (2) the relationship of NFC to SFC before the 1989-1992 logging in the North Fork.

The calibration water years used in the South Fork analysis were 1963-1967, before road construction. The sediment load in 1968, after road construction, did not conform to the pretreatment regression (*fig. 2a*), but the data from the years 1969-1971 were not significantly different from the 1963-1967 data (Chow test, $p = 0.10$). In 1968, the increase in suspended load was 1,475 kg ha⁻¹, an increase of 335 percent over that predicted for an undisturbed condition. The years 1972-1978 (during and after logging) again differed from the pretreatment regression. Water year 1977 was missing owing to instrument malfunction. By 1979, the suspended sediment load at SFC had returned to pretreatment levels. The increased suspended load after logging amounted to 2,510 kg ha⁻¹yr⁻¹, or an increase of 212 percent over that predicted for the 6-yr period by the regression. (Predictions were corrected for bias when backtransforming from logarithms to original units.) The greatest absolute increases occurred in the years 1973 and 1974, followed by 1975 (*fig. 2b*).

A pair of large landslides (one in each watershed) occurred during hydrologic year 1974, complicating the analysis by Rice and others (1979), where the North Fork's sediment load was adjusted downward because most of the North Fork slide reached the stream, while most of the South Fork slide did not. However, that year did not appear anomalous in my analysis, and I did not make any adjustments. But the unadjusted prediction requires extrapolation of the regression line well beyond the range of the pretreatment

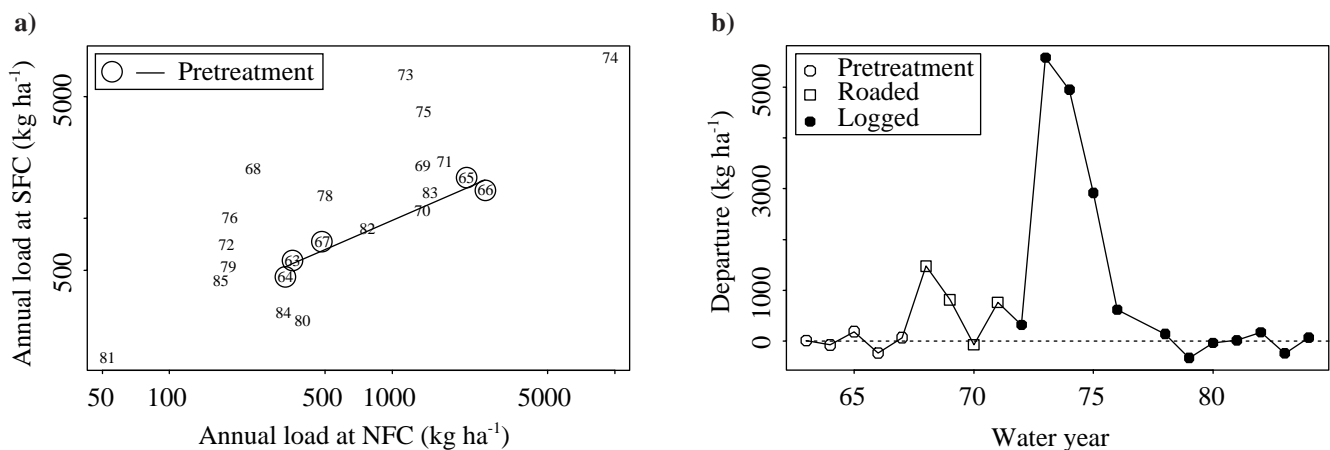

Figure 2—(a) Relation between estimated annual suspended sediment loads at South Fork Caspar Creek (SFC) and North Fork Caspar Creek (NFC) from 1963 to 1985. Pretreatment regression line is fit to the water years before roading and logging activity in the South Fork. (b) Time series of departures from the regression line.

data, so it is still suspect. If the adjustment of Rice and others (1979) is applied in my analysis, the revised increase in suspended sediment load is 2,835 kg ha⁻¹yr⁻¹, or an increase of 331 percent over that predicted for the 6-yr period. The adjusted figure reported for the 5-yr period (1972-1976) by Rice and others was 3,245 kg ha⁻¹yr⁻¹, an increase of 354 percent over that predicted.

Although no statistically significant logging effect on pond accumulation was detected, regression analysis using total sediment load (including data from 1974) revealed a similar pattern of impacts as that of the suspended load. The increased total sediment load after logging of the South Fork amounted to 2,763 kg ha⁻¹yr⁻¹, or an increase of 184 percent over that predicted for the 6-yr period by the regression.

Annual Sediment Loads after Logging the North Fork

The calibration period used in the North Fork analysis includes 1979-1985, the years after the South Fork's apparent recovery, as well as 1963-1967. The years 1986-1989 were not included in the calibration period because the Y and Z units were logged in 1985 and 1986. Applying the Chow test, neither 1986-1989 (p = 0.43) nor 1990-1995 (p = 0.53) was found to differ significantly from the suspended sediment calibration regression (fig. 3a). The (nonsignificant) departures from the regression predictions averaged 118 kg ha⁻¹yr⁻¹, amounting to just 28 percent above that predicted for the 6-yr period by the regression (fig. 3b). No effect was detected for pond accumulation by itself or total sediment load. For total sediment load, the (nonsignificant) departures from the regression predictions averaged -80 kg ha⁻¹yr⁻¹, or 8 percent below that predicted for the 6-yr period by the regression.

The absolute numbers reported in the above and earlier analyses of the South Fork logging (Rice and others 1979) must be viewed with reservation. The suspended load estimates were based on hand-drawn sediment rating curves describing the relation between the

concentration of samples collected in a given year to the discharge levels at which they were collected. In several years, samples were not available from all discharge classes, so it was necessary to extrapolate the relation between concentration and discharge to higher or lower unrepresented classes. Also, a majority of the samples from the years 1963-1975 were collected using single-stage samplers that are filled only during the rising limb of hydrographs. In most storm events we have measured at Caspar Creek, the concentrations are markedly higher on the rising limb of the hydrograph than for equivalent discharges on the falling limb (e.g., fig. 4). Therefore, the fitted concentrations were likely too high. A plot of estimated sediment loads at NFC against annual water yield for the pre-logging years (fig. 5) suggests that there may be a positive bias during the single-stage years. The error associated with this method certainly varies from year to year, depending on the numbers of single-stage and manual samples and their distribution relative to the hydrographs. However, the plot indicates that loads were overestimated by a factor of between 2 and 3 in the range where most of the data occur. A comparison of the annual loads for the years 1986-1995 with annual sums of storm loads (the most accurate) shows very little bias, indicating that bias in the early years resulted mainly from sampling protocols rather than the computational method, which was the same for all years in this analysis.

North Fork Analysis Using Unlogged Subwatersheds as Controls

Because of improved and more intensive sampling methods, the suspended sediment loads for storm events beginning in 1986 are known far more accurately than the annual loads used in the NFC/SFC contrasts presented above. Four unlogged control watersheds were available (HEN, IVE, MUN, and SFC) for the analysis of storm loads. Unfortunately, only one large storm was available before logging. That storm was missed at SFC because of pumping sampler problems. Because of various technical difficulties, not all storms

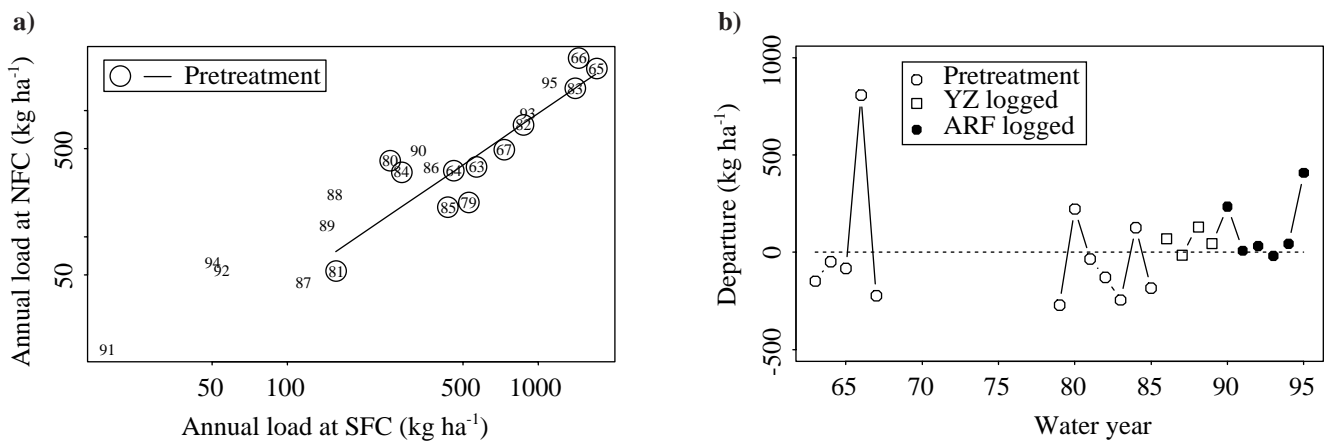

Figure 3—(a) Relation between estimated annual suspended sediment loads at North Fork Caspar Creek (NFC) and South Fork Caspar Creek (SFC) from 1963 to 1967 and 1979 to 1995, excluding years when sediment was elevated following logging in the South Fork. Pretreatment regression line is fit to the water years before roading and logging activity in the North Fork. (b) Time series of departures from the regression line.

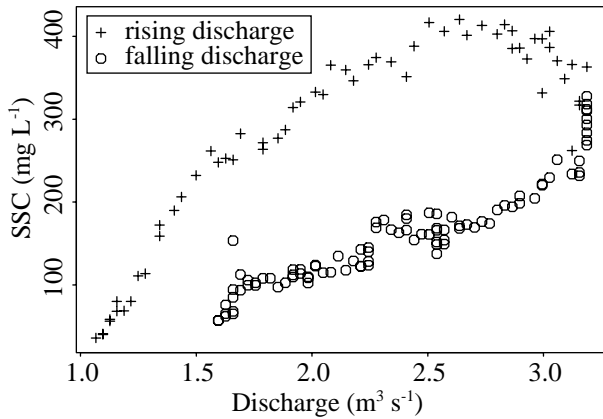

Figure 4—Storm event at lower main-stem station ARF, January 13-14, 1995, with water discharge and laboratory sediment concentrations (SSC) at 10-minute intervals.

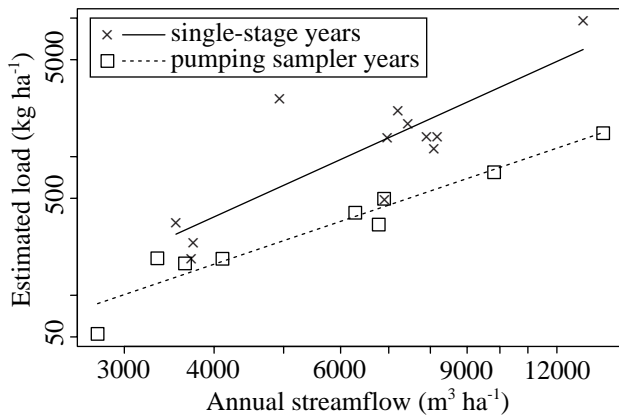

Figure 5—Relations between estimated annual suspended sediment loads and annual streamflow at North Fork Caspar Creek (NFC) prior to logging. Illustrates that load estimates based on sediment rating curves depend systematically on sampling protocols.

were adequately sampled at each station. However, the sample size for analyses was increased by using the mean of available data from the three tributary control watersheds, HEN, IVE, and MUN, in each storm. (SFC was eliminated because it had lower pretreatment correlations with the North Fork stations.) This mean (denoted HIM) provided a pretreatment sample size of 17 storms. The more accurate sediment loads, better controls, and larger sample size gave this analysis greater reliability and increased power to detect changes than the annual load analysis.

A weakness in analyses of logging effects at NFC was the need to use 1986-1989 as a calibration period even though 12 percent of the area had been clearcut. The clearcut area might be expected to somewhat diminish the size of the effect detected. The occurrence of only one large storm event before logging is mitigated by the fact that it was thoroughly sampled at both NFC and the three controls.

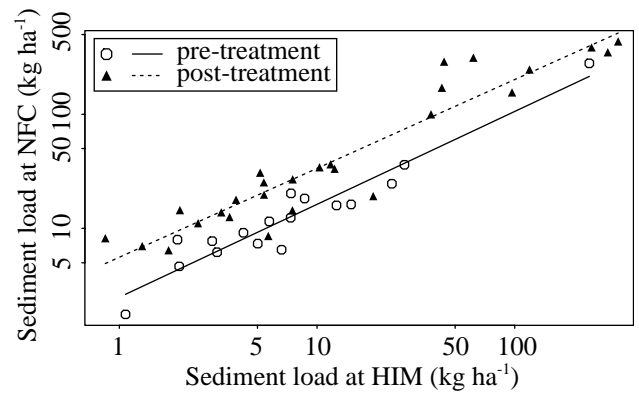

Figure 6—Relation between storm suspended sediment loads at North Fork Caspar Creek (NFC) and HIM control (mean suspended load of unlogged tributaries HEN, IVE, and MUN) from 1986 to 1995. Pretreatment regression line is based on storms in water years 1986-1989, before the major logging activity began.

An average of 59 sample bottles were collected at each of the four stations, and all the standard errors were less than 10 percent of the estimated loads, so there is little doubt about this point's validity.

Figure 6 shows regression lines fit to the suspended storm loads at NFC versus those at HIM before and after logging began in the spring of 1989. There was clearly an increase in suspended loads in small storms after logging began. In large storms there also seems to be an effect, although some post-treatment points are very close to the one large pretreatment point. The Chow test for a change after logging was significant with $p = 0.006$. The increases over predicted load, summed over all storms in the post-treatment period, average $188 \text{ kg ha}^{-1}\text{yr}^{-1}$, and amount to an 89 percent increase over background. The storms in this analysis represent 41 percent of the 1990-1996 streamflow at NFC, but carried approximately 90 percent of the suspended sediment that passed over the weir (based on figure 2 of Rice and others 1979).

A $3,600\text{-m}^3$ landslide that occurred in the Z cut unit (Preface, fig. 2, these proceedings) increased sediment loads at the NFC gaging station starting in January 1995. NFC was the only gage downstream from this slide. The sum of suspended loads from storms preceding the landslide was 47 percent higher ($64 \text{ kg ha}^{-1}\text{yr}^{-1}$) than predicted. The sum of suspended loads from storms after the landslide was 164 percent higher ($150 \text{ kg ha}^{-1}\text{yr}^{-1}$) than predicted.

Individual Regressions for Subwatersheds

Similar analyses for each of the subwatersheds in the North Fork (fig. 7 and table 1) indicate increased suspended sediment loads in all the clearcut tributaries except KJE. Sediment loads in the KJE watershed appear to have decreased after logging. The only partly clearcut watershed on a tributary (DOL) also showed highly significant increases in sediment loads. The upper main-stem stations (JOH and LAN) showed no effect after logging, and the lower main-stem stations (FLY and ARF) experienced increases only in smaller storms. Summing suspended sediment over all storms, the four main-stem stations all showed little or no change (table 1).

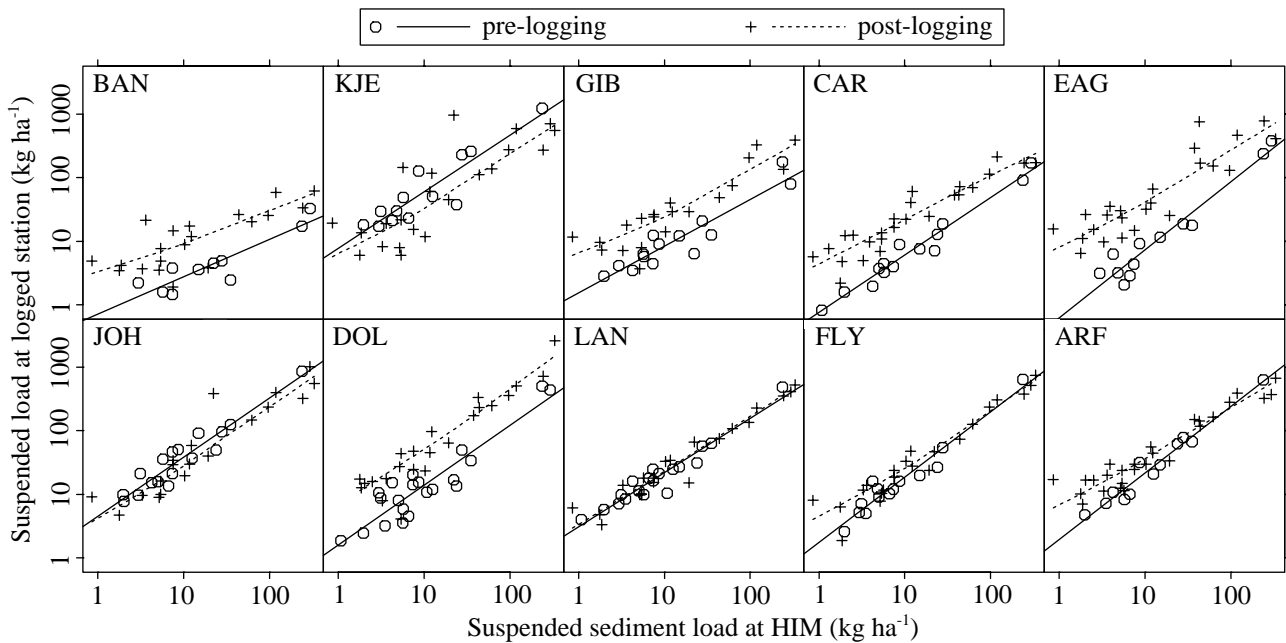

Figure 7—Relations between storm suspended sediment loads at logged subwatersheds in the North Fork and HIM control (mean suspended load of unlogged tributaries HEN, IVE, and MUN) from 1986 to 1995. Pre-logging regression lines are based on pretreatment years that are specific to each subwatershed. Post-logging relations are not assumed to be linear, hence were fitted by locally weighted regression (Cleveland 1993).

Table 1—Summary of changes in suspended sediment load (summed over storms) after logging in North Fork subwatersheds. Predicted loads are computed from pre-treatment linear regressions between the logarithms of the storm sediment load in the treated watershed and the mean of the storm sediment loads at the control watersheds HEN, IVE, and MUN. Predictions were corrected for bias when back-transforming from logarithmic units. The number of years in the post-logging period varies from 4 to 6, depending upon when the watershed was logged and whether or not monitoring was discontinued in water year 1996.

Treated watershed	Number of years	Observed (kg ha ⁻¹ yr ⁻¹)	Predicted (kg ha ⁻¹ yr ⁻¹)	Change (kg ha ⁻¹ yr ⁻¹)	Change (%)
ARF	4	505	591	-86	-15
BAN	4	85	28	57	203
CAR	5	240	108	132	123
DOL	5	1130	306	824	269
EAG	5	710	210	500	238
FLY	5	536	555	-19	-3
GIB	4	358	119	239	200
JOH	5	667	865	-198	-23
KJE	5	821	1371	-551	-40
LAN	5	420	400	20	5
NFC	6	465	246	219	89

Aggregated Regression Model for Subwatersheds

To evaluate the relationships between suspended sediment load increases and possible explanatory variables, an aggregated regression model was fit simultaneously to all the subwatershed storms. The model utilized 367 estimated loads from 51 storms when HIM was used as the control or 333 estimated loads from 43 storms when HI (the mean of HEN and IVE) was used. Two regression coefficients were fitted for each watershed. A number of disturbance measures were considered (table 2), as well as an area term designed to describe cumulative effects, and a term explaining sediment increases in terms of flow increases. A great deal of effort went into developing a model that would permit valid tests of hypotheses concerning cumulative watershed effects. Therefore, the response model is coupled with a covariance model that describes variability in terms of watershed area and correlation among subwatershed responses as a function of distance between watersheds. These models were solved using the method of maximum likelihood and will be described in detail in a separate publication (Lewis and others 1998).

Departures from sediment loads predicted by the aggregated model for undisturbed watersheds were modest. The median increase in storm sediment load was 107 percent in clearcuts and 64 percent in partly clearcut watersheds. The median annual increase was 109 percent (58 kg ha⁻¹yr⁻¹) from clearcut watersheds and 73 percent (46 kg ha⁻¹yr⁻¹) from partly clearcut watersheds. The absolute flux values are underestimated somewhat because they include only sediment measured in storms, and no effort has been made to adjust for missing data. However, the major storms have been included, and virtually all of the sediment is transported during storms. Uncertainty due to year-to-year variability is certainly a much greater source of error.

The most important explanatory variable identified by the model was increased volume of streamflow during storms. Storm flow predictions (Ziemer, these proceedings) were based on an aggregated model analogous to that used for predicting sediment loads. The ratio of storm sediment produced to that predicted for an unlogged condition was positively correlated to the ratio of storm flow produced to that predicted for an unlogged condition (fig. 8). This result is not unexpected because, after logging, increased storm

flows in the treated watersheds provide additional energy to deliver and transport available sediment and perhaps to generate additional sediment through channel and bank erosion.

Whereas individual watersheds show trends indicating increasing or decreasing sediment loads, there is no overall pattern of recovery apparent in a trend analysis of the residuals from the model (fig. 9a). This is in contrast with the parallel model for storm flow volume (fig. 9b), and suggests that some of the sediment increases are unrelated to flow increases.

Other variables found to be significant were road cut and fill area, and, in models using the HI control, the length of unbuffered stream channel, particularly in burned areas. Under California Forest Practice Rules in effect during the North Fork logging, buffers were not required for stream channels that do not include aquatic life and are not used by fish within 1,000 feet downstream except in confluent waters. As discussed earlier, one must be cautious about drawing conclusions about cause and effect when treatments are not randomly assigned to experimental units and replication is limited. Increases in sediment load in one or two watersheds can create associations with any variable that happens to have higher values in those watersheds, whether or not those variables are physically related to the increases. In this study, the contrast in response is primarily between watershed KJE, where sediment loads decreased, versus watersheds BAN, CAR, DOL, EAG, and GIB. Watershed KJE was unburned and also had the smallest amount of unbuffered stream of all the cut units. Watersheds EAG and GIB were burned and had the greatest amount of unbuffered stream in burned areas. Watershed EAG experienced the largest sediment increases and also had the greatest proportion of road cut and fill area. Because EAG was not unusually high in road surface area, the large road cut and fill area indicates that the roads in EAG are on steeper hillslopes.

There is little field evidence of sediment delivery from roads in

Table 2—Explanatory variables considered in modeling storm sediment loads in North Fork subwatersheds.

Mean unit area suspended load from control watersheds
Excess storm flow volume relative to that of control watersheds
Time since logging completed
Timber removed per unit watershed area
Areas of various disturbances as proportion of watershed:
Cable, tractor yarding
Stream protection zones, thinned areas
Burning (low intensity, high intensity)
Road cuts, fills, running surfaces
Skid trail cuts, fills, operating surfaces
Landing cuts, fills, operating surfaces
Areas of above disturbances within 46 m (150 ft) of a stream channel
Length of impacted stream in above disturbances per unit watershed area
Length of cabled corridors per unit watershed area
Watershed area

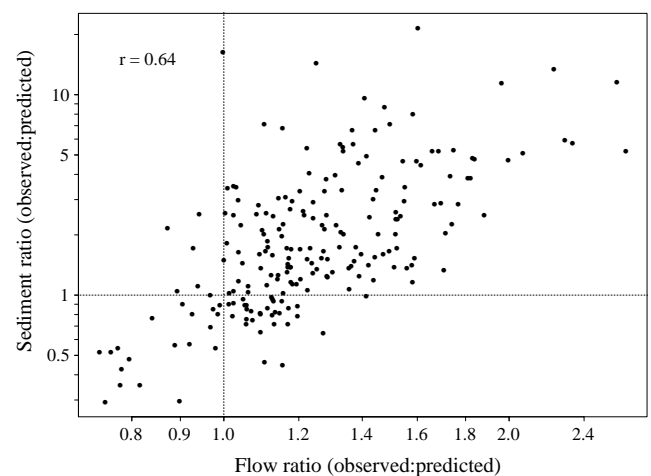

Figure 8—Relation between post-logging ratios of observed to predicted storm flow and suspended sediment load for all North Fork subwatersheds. Predictions are for undisturbed watersheds based on aggregated regression models using HI control (mean response of unlogged tributaries HEN and IVE).

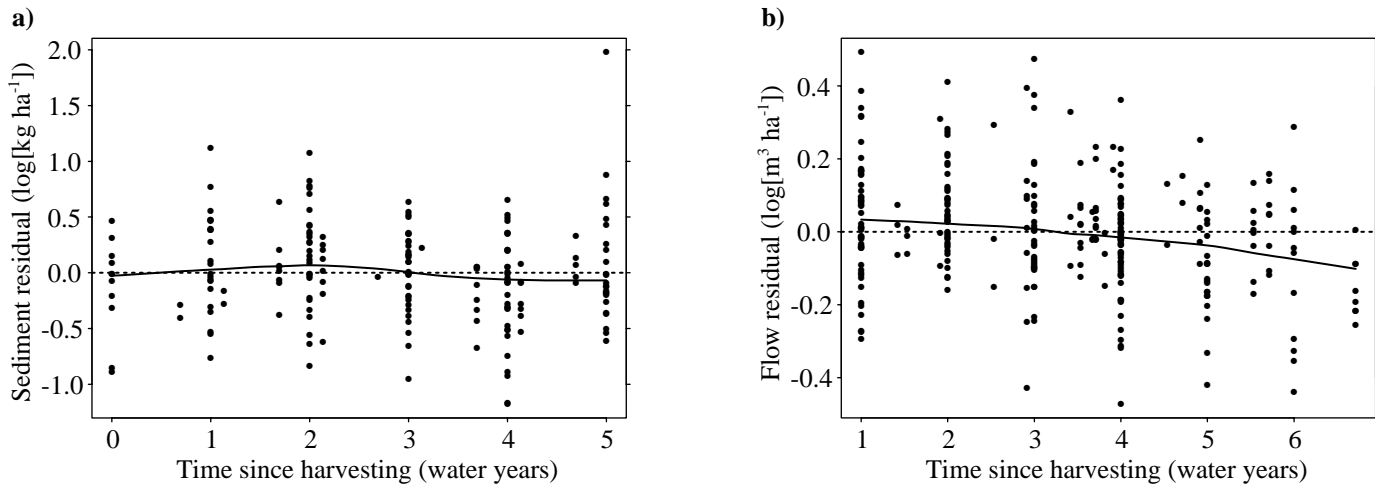

Figure 9—Relation between post-logging residuals from aggregated models and time (difference in water years) since harvesting. (a) model for storm suspended sediment loads, and (b) model for storm flow volumes. Curves were fitted by locally weighted regression (Cleveland 1993).

the North Fork watershed. In the inventory of failures greater than 7.6 m³, only 8 of 96 failures, and 1,686 of 7,343 m³ of erosion were related to roads. Nearly all of this road-related erosion was recorded as remaining on-site, and none of the road-related failures occurred in the EAG watershed. Based on the 129 random erosion plots (Rice 1996), the road erosion in EAG was 9.3 m³ha⁻¹, compared to 34.5 m³ha⁻¹ for KJE and 16.6 m³ha⁻¹ for all roads in the North Fork. Thus it seems that the appearance of road cuts and fills in the model resulted from a spurious correlation.

On the other hand, channel reaches subjected to intense broadcast burns did show increased erosion from the loss of woody debris that stores sediment and enhances channel roughness (Keppeler, electronic communication). And increased flows, accompanied by soil disruption and burning in headwater swales, may have accelerated channel headward expansion, and soil pipe enlargements and collapses observed in watershed KJE (Ziemer 1992) and in EAG, DOL, and LAN.

Based on the 175 random erosion plots in harvest areas (Rice 1996), the average hillslope erosion rates in the burned watersheds EAG and GIB were 153 m³ha⁻¹ and 77 m³ha⁻¹, respectively, the highest of all the watersheds. The average rate for the unburned clearcut watersheds BAN, CAR, and KJE was 37 m³ha⁻¹. These figures include estimates of sheet erosion, which is difficult to measure and may be biased towards burned areas because it was easier to see the ground where the slash had been burned (Keppeler, verbal communication). About 72 percent of EAG and 82 percent of GIB were judged to be thoroughly or intensely burned, and the remainder was burned lightly or incompletely. It is unknown how much of this hillslope erosion was delivered to stream channels, but the proportion of watershed burned was not a useful explanatory variable for suspended sediment transport.

The failure inventory identified windthrow as another fairly important source of sediment. Of failures greater than 7.6 m³, 68

percent were from windthrow. While these amounted to only 18 percent of the failure volume measured, 91 percent of them were within 15 m of a stream, and 49 percent were in or adjacent to a stream channel. Because of the proximity of windthrows to streams, sediment delivery from windthrow is expected to be disproportionate to the erosion volume. Windthrows are also important as contributors of woody debris to channels (Reid and Hilton, these proceedings), and play a key role in pool formation (Lisle and Napolitano, these proceedings). Because woody debris traps sediment in transport, it is unknown whether the net effect of windthrow on sediment transport was positive or negative.

Cumulative Effects

A full explanation of the rationale and methods of testing for cumulative watershed effects is beyond the scope of this paper, and final results on this topic will be reported by Lewis and others (1998). Preliminary results will simply be stated here.

I have considered three types of information that the aggregated model provides about the cumulative effects of logging activity on suspended sediment loads:

1. Were the effects of multiple disturbances additive in a given watershed?
2. Were downstream changes greater than would be expected from the proportion of area disturbed?
3. Were sediment loads in the lower watershed elevated to higher levels than in the tributaries?

The response being considered in all of these questions is the suspended sediment load per unit watershed area for a given storm event. Watershed area was used in the model to represent distance downstream.

The first question may be answered partly by looking at the forms of the storm flow and sediment models. Analyses of the residuals and covariance structures provide good evidence that the models are appropriate for the data, including the use of a logarithmic response variable. This implies a multiplicative effect for predictors that enter linearly and a power function for predictors that enter as logarithms. It turns out that the flow response to logged area is multiplicative, and the sediment response to flow increases is a power function. These effects, however, are *approximately* additive within the range of data observed for watersheds receiving flow from multiple cut units.

The second question was addressed by testing terms formed from the product of disturbance and watershed area. If the coefficient of this term were positive, it would imply that the effect of a given disturbance proportion increases with watershed size. A number of disturbance measures were considered, including road cut and fill area and length of unbuffered stream channels. None of the product terms were found to have coefficients significantly greater than zero, indicating that suspended load increases were not disproportionately large in larger watersheds. To the contrary, the sum of the observed sediment loads at the four main-stem stations were all within 25 percent of the sum of the loads predicted for undisturbed watersheds (*table 1*). Apparently, much of the sediment measured in the tributaries has been trapped behind woody debris or otherwise stored in the channels, so that much of it has not yet been measured downstream.

There is, however, one subwatershed where this second type of cumulative effect may be occurring. Watershed DOL, only 36 percent cut, includes the 100 percent cut watershed EAG, yet the sediment increases (269 percent at DOL versus 238 percent at EAG) have been similar. The increases in DOL seem to be related to channel conditions created in the historic logging (1900-1904) and, possibly, to increased flows from recent logging. At the turn of the century, the channel between the DOL and EAG gaging stations was used as a "corduroy road" for skidding logs by oxen. Greased logs were half-buried in the ground at intervals equal to the step length of the oxen (Napolitano 1996), and an abundance of sediment is stored behind them today (Keppeler, electronic communication). Energy available during high flows may be mobilizing sediment stored behind these logs. In the lower reach, the channel has a low width:depth ratio and is unable to dissipate energy by overflowing its banks. The high banks in this reach would be particularly vulnerable to increased peak flows, and have failed in a number of places in the years since EAG was logged.

The third question was addressed by testing watershed area as a linear term in the model. The coefficient of watershed area was positive ($p = 0.0023$), implying that the response, suspended sediment transport per unit watershed area, tends to increase downstream in the absence of disturbance. This tendency (with the exception of watershed KJE) is apparent in the pretreatment lines fit by least squares (*fig. 10a*), and could be reflecting the greater availability of fine sediment stored in these lower gradient channels. The relevance to cumulative effects is that downstream locations might reach water quality levels of concern with a smaller proportion of watershed disturbance than upstream locations.

To the extent that larger watersheds reflect average disturbance rates and therefore have smaller proportions of disturbance than the smallest disturbed watersheds upstream, one might expect sediment loads downstream to increase by less than those in the logged tributaries, reducing the overall variability among watersheds. In addition, as mentioned before, some of the sediment may be stored for several years before reaching the lower stations. That is what we observed in this study—the post-treatment regression lines (*fig. 10b*) were much more similar among watersheds than the pretreatment lines, and the main-stem stations no longer transported the highest sediment loads relative to watershed area.

Discussion

North Fork versus South Fork

My analysis of the South Fork logging data used a different model than was used by Rice and others (1979). However, the estimated increases in sediment loads were similar. For example, they reported suspended load increases of $1,403 \text{ kg ha}^{-1}\text{yr}^{-1}$ in the year after road construction and $3,254 \text{ kg ha}^{-1}\text{yr}^{-1}$ for the 5-yr period after logging. For the same periods, I estimated increases of 1,475 and $2,877 \text{ kg ha}^{-1}\text{yr}^{-1}$. Reversing the roles of the two watersheds for the later North Fork logging, the same analysis was unable to detect an effect. However, analysis of storm event loads from 1986 to 1996, using smaller subwatersheds within the North Fork as controls that had similar 19th-century logging histories as the whole North Fork, indicated that storm loads at NFC had increased by $188 \text{ kg ha}^{-1}\text{yr}^{-1}$. When comparing these figures, one should consider the differences between the water years 1972-1978 and 1990-1996, as well as differences in sampling methodologies that could have biased the estimated sediment loads. The mean annual unit area streamflow in the control (NFC) was 63 percent higher in 1972-1978 than that in the control (SFC) in 1990-1996. There is a surprisingly good relation between annual excess sediment load (departures from the pre-treatment regression) and water discharge in each of the studies (*fig. 11*). For equivalent flows, excess sediment loads in the South Fork analysis were six to seven times those in the North Fork analysis. It is probable that the sampling methods in the 1960's and 1970's resulted in overestimation of sediment loads in the South Fork analysis by a factor of 2 or 3. Therefore, comparisons between *relative* increases are more appropriate. Excess suspended load was 212 percent to 331 percent (depending on whether an adjustment is made for the 1974 North Fork landslide) after logging the South Fork, and 89 percent after logging the North Fork, suggesting that the effect of logging on suspended sediment load was 2.4 to 3.7 times greater in the South Fork than in the North Fork. These estimates approximately agree with estimates (Rice 1996) that both erosion and the sediment delivery ratio in the South Fork were about twice that in the North Fork.

Subwatersheds and KJE Anomaly

Analyses of the 10 treated subwatersheds in the North Fork drainage show suspended load increases at the gaging stations located

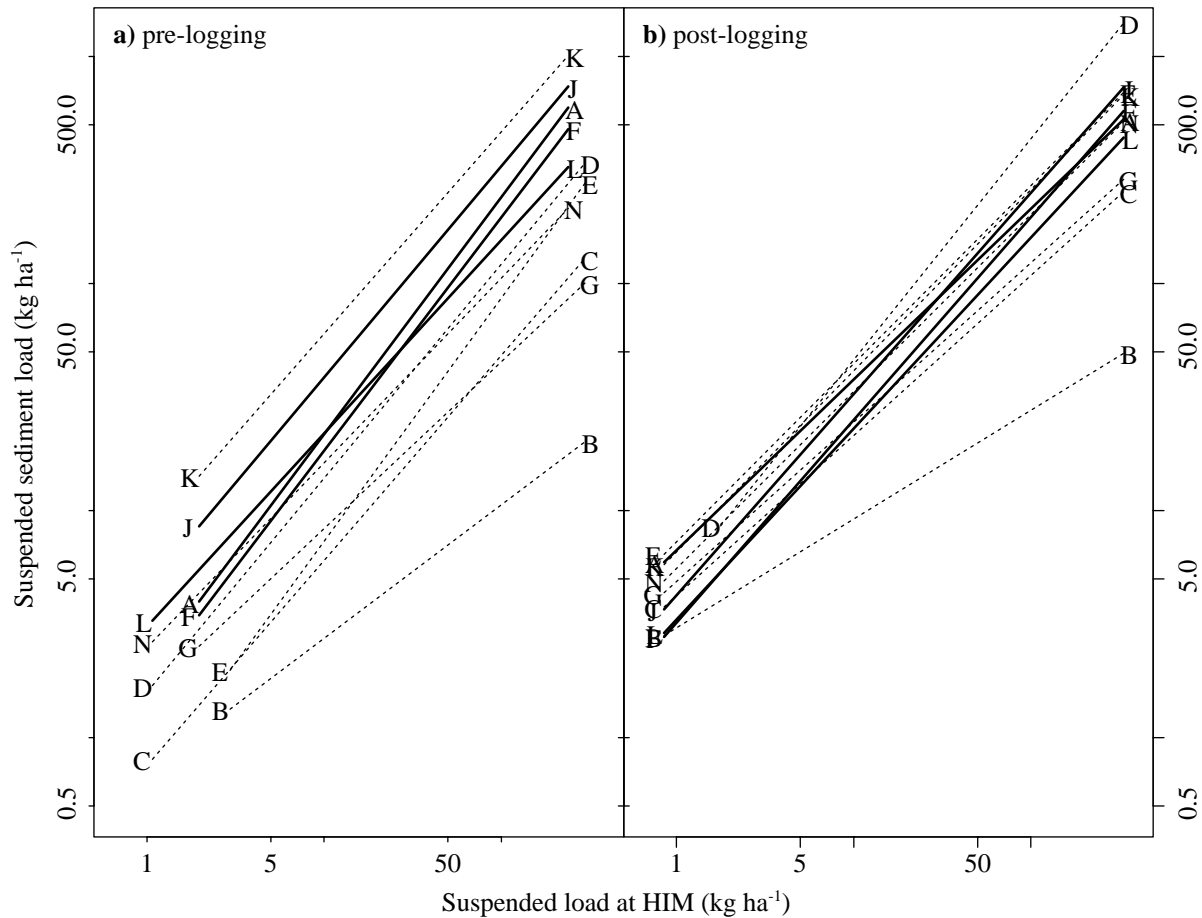

Figure 10—Regression lines for storm suspended sediment loads at treated watersheds in the North Fork, predicted from HIM control (mean suspended load of unlogged tributaries HEN, IVE, and MUN). (a) pre-logging, and (b) post-logging. Solid lines represent main-stem stations and dashed lines represent tributary stations.

immediately below clearcut units with one exception. At KJE, loads have decreased. A possible explanation for this anomaly lies in the tributary channel morphology. The stream channel in the KJE watershed is an extension of the main stem of the North Fork. It is (and, before recent logging, was) more deeply incised than the other tributaries, and it has the lowest gradient of tributaries other than the reach between the DOL and EAG gaging stations. The channel may have taken its gully-like form after the historic logging that took place between 1860 and 1904, when streams and streambeds were used as conduits for moving logs (Napolitano 1996). In any case, KJE had the highest pre-logging (1986-1989) unit area sediment loads of any of the tributaries (*fig. 10a*). Sediment in its channel is plentiful and the banks are actively eroding. It is likely, then, that the pre-logging sediment regime in KJE may have been energy-limited, which is more characteristic of disturbed watersheds. That is, sediment discharge was determined more by the ability of the stream to transport sediment than by the availability of sediment to be transported.

After logging, woody debris was added to the channel, and the

number of organic steps in the buffered stream above KJE nearly doubled. Farther upstream, the channel was no longer shaded by the forest canopy and became choked with new redwood sprouts, horsetails, berry vines, and ferns, as well as slash that was introduced during logging. Although small storm flows did increase after logging, it is possible that channel roughness could have increased enough to reduce the energy available for sediment transport. An energy-limited stream would respond to increased sediment supply and reduced energy by reducing sediment transport. On the other hand, tributaries in a supply-limited sediment regime would have responded to a combination of increased sediment supply and reduced energy by increasing sediment transport. At some point, the increased supply probably converted these channels to an energy-limited regime, at which point stream power became the primary factor controlling variation in the increased transport levels. Rice and others (1979) concluded that is what happened after logging in the South Fork.

The aggregated regression for storm flow volumes (Lewis and others 1998; Ziemer, these proceedings) showed that flow increases

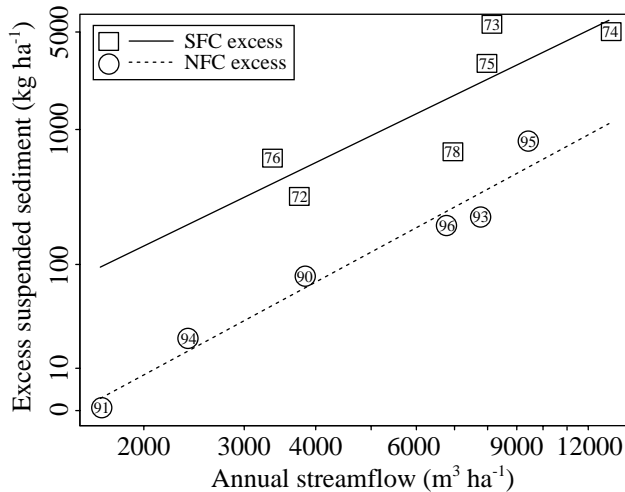

Figure 11—Relations between annual excess suspended sediment and annual streamflow for six years after logging in the South Fork and North Fork. South Fork excess loads are the departures from the pretreatment regression of figure 2. North Fork excess loads are the sums of storm departures from the pretreatment regression of figure 6.

could be largely explained by the proportion of a watershed logged, an antecedent wetness index, and time since logging. The aggregated regression for storm suspended sediment showed that much of the variability in suspended sediment load could, in turn, be explained by the flow increases. The implication is that, after logging, the channels were indeed in an energy-limited regime.

Flow increases accounted for only part of the variability in sediment production. Road systems would typically be expected to account for much of the sediment. However, in this case, roads were relatively unimportant as a sediment source because of their generally stable locations on upper hillslopes far from the stream channels. Field observations of increased bank erosion and gully expansion in clearcut headwater areas indicate that some of the suspended sediment increases were associated with the length of unbuffered stream channels in burned areas and, to a lesser degree, in unburned areas. Further indirect evidence that factors besides flow volume are elevating the suspended loads is that storm flows show a recovery trend, whereas storm suspended loads do not (*fig. 9*). This supports the hypothesis that the sediment regime has changed to one that will support elevated transport levels until the overall sediment supply is depleted. This can happen only after erosion and delivery rates to the channel decline and flows have been adequate to export excess sediment stored in the channels.

Cumulative Effects

Before logging, the larger main stem watersheds generally yielded the highest unit area sediment loads. But the increases after logging were greatest in the tributaries, resulting in a much narrower range of transport, for a given storm size, after logging (*fig. 10*). The North Fork of Caspar Creek is a small watershed (4.73 km²). To see

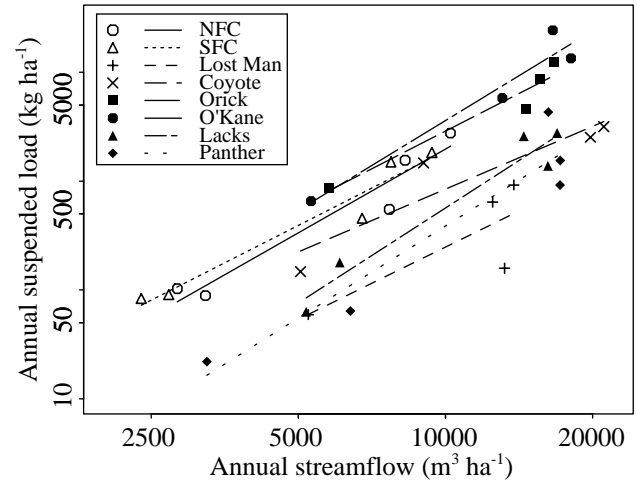

Figure 12—Relation between annual suspended sediment loads and annual streamflow for water years 1992-1996 at North Fork Caspar Creek (NFC), South Fork Caspar Creek (SFC), and 6 gaging stations in the vicinity of Redwood National Park. Caspar Creek sediment loads were divided by 0.6 to account for suspended sediment settling in the weir ponds.

whether these results might be generalizable to larger watersheds, annual sediment loads for water years 1992-1996 were plotted against annual water yield (*fig. 12*) for NFC, SFC, and six gaging stations on streams in the vicinity of Redwood National Park (RNP). These watersheds were selected because of the high quality of their data and because, like Caspar Creek, they are underlain by the highly erodible Franciscan formation and historically supported mostly redwood forest with varying amounts of Douglas-fir. Caspar Creek receives less rainfall than the RNP watersheds, hence the lower annual flows.

In contrast to Caspar Creek, the RNP main-stem stations (Redwood Creek at Orick, 720 km², and at O'Kane, 175 km²) continue to yield higher sediment loads than the RNP tributaries even after intensive management. Except for Little Lost Man Creek, these watersheds have been heavily logged at various times over the past 50 years, including the 1980's and 1990's. (Ground disturbance from logging in these watersheds was much more severe than that in Caspar Creek.)

The watershed with the lowest sediment loads is the unlogged Little Lost Man Creek (9.0 km²), which is also the smallest of the RNP watersheds. Lacks Creek (44 km²), Coyote Creek (20 km²), and Panther Creek (16 km²) are high-gradient (4-7 percent) channels in three different geologic subunits of the Franciscan formation (Harden and others 1982). Part of the explanation for the higher sediment loads at the main-stem stations may lie in the greater abundance of fine sediments available for transport in these low gradient (<1 percent) channels. Note that the Caspar Creek main stems are intermediate in both stream gradient (~1 percent) and sediment transport between the RNP tributaries and main stems. Regardless of the cause, if these lower reaches have the poorest

water quality, then the incremental effect of an upstream disturbance may be cause for concern whether or not a water quality problem develops at the site of the disturbance. In other words, activities that have acceptable local consequences on water quality might have unacceptable consequences farther downstream when the preexisting water quality downstream is closer to harmful levels.

Cumulative effects considered in this paper were limited to a few hypotheses about water quality that could be statistically evaluated. But cumulative effects can occur in many ways. For example, resources at risk are often quite different in downstream areas, so an activity that has acceptable local impacts might have unacceptable offsite impacts if critical or sensitive habitat is found downstream. For a much broader treatment of cumulative effects see the discussion by Reid (these proceedings).

Conclusions

The main conclusions from these analyses are:

- Improved forest practices resulted in smaller increases in suspended load after logging the North Fork than after logging the South Fork. Increases were 2.4 to 3.7 times greater in the South Fork with roads located near the stream, all yarding by tractor, and streams not protected.
- Much of the increased sediment load in North Fork tributaries was related to increased storm flow volumes. With flow volumes recovering as the forest grows back, these increases are expected to be short-lived.
- Further sediment reductions in the North Fork probably could have been achieved by reducing or preventing disturbance to small drainage channels.
- Sediment loads are probably affected as much by channel conditions as by sediment delivery from hillslopes. The observed changes in sediment loads are consistent with conversion of those channels that were supply-limited before logging to an energy-limited regime after logging.
- The effects of multiple disturbances in a watershed were approximately additive.
- With one exception, downstream suspended load increases were no greater than would be expected from the proportion of area disturbed. To the contrary, most of the increased sediment produced in the tributaries was apparently stored in the main stem and has not yet been measured at the main-stem stations.
- Before logging, sediment loads on the main stem were higher than on most tributaries. This was no longer the case after logging. However, limited observations from larger watersheds suggest that downstream reaches in some watersheds are likely to approach water-quality levels of concern before upstream reaches.

References

- Bozek, M.A.; Young, M.K. 1994. **Fish mortality resulting from delayed effects of fire in the Greater Yellowstone Ecosystem.** Great Basin Naturalist 54(1): 91-95.
- Chow, G.C. 1960. **A test of equality between sets of observations in two linear regressions.** Econometrica 28: 591-605.
- Cleveland, W.S. 1993. **Visualizing data.** Summit, NJ: Hobart Press; 360 p.
- Colby, B.R. 1956. **Relation of sediment discharge to streamflow.** U.S. Geological Survey Open File Report; 170 p.
- DeBano, L.F. 1979. **Effects of fire on soil properties.** In: Laacke, R.J., ed. California forest soils. Berkeley, CA: Agricultural Sciences Publications, Division of Agricultural Sciences, University of California; 109-117.
- Dodge, M.; Burcham, L.T.; Goldhaber, S.; McGully, B.; Springer, C. 1976. **An investigation of soil characteristics and erosion rates on California forest lands.** Sacramento, CA: California Division of Forestry; 105 p.
- Durgin, P.B.; Johnston, R.R.; Parsons, A.M. 1989. **Critical sites erosion study, Vol. 1, Causes of erosion on private timberlands in northern California: observations of the interdisciplinary team.** Sacramento, CA: California Department of Forestry and Fire Protection, Forest Practices Section; 50 p.
- Eads, R.E.; Booloottian, M.R. 1985. **Controlling suspended sediment samplers by programmable calculator and interface circuitry.** Res. Note PSW-376. Berkeley, CA: Pacific Southwest Forest and Range Experiment Station, Forest Service, U.S. Department of Agriculture; 8 p.
- Federal Inter-Agency Committee on Water Resources, Subcommittee on Sedimentation. 1952. **The design of improved types of suspended sediment samplers.** Measurement and analysis of sediment loads in streams, Report No. 6. Minneapolis, MN: Project Offices of Cooperating Agencies, St. Anthony Falls Hydraulic Laboratory; 103 p.
- Gregory, R.S. 1993. **The effect of turbidity on the predator avoidance behaviour of juvenile chinook salmon (*Oncorhynchus tshawytscha*).** Canadian Journal of Fisheries and Aquatic Sciences 50: 241-246.
- Gregory, R.S.; Northcote, T.G. 1993. **Surface, planktonic, and benthic foraging by juvenile chinook salmon (*Oncorhynchus tshawytscha*) in turbid laboratory conditions.** Canadian Journal of Fisheries and Aquatic Sciences 50: 233-240.
- Gregory, R.S.; Servizi, J.A.; Martens, D.W. 1993. **Comment: utility of the stress index for predicting suspended sediment effects.** North American Journal of Fisheries Management 13: 868-873.
- Harden, D.R.; Kelsey, H.M.; Morrison, S.D.; Stephens, T.A. 1982. **Geologic map of the Redwood Creek drainage basin, Humboldt County, California.** U.S. Geological Survey Water Resources Investigations Open File Report 81-496. Menlo Park, CA: U.S. Geological Survey.
- Inter-Agency River Basin Committee, Subcommittee on Sedimentation. 1961. **The single-stage sampler for suspended sediment.** Measurement and analysis of sediment loads in streams, Report No. 13. Minneapolis, MN: Project Offices of Cooperating Agencies, St. Anthony Falls Hydraulic Laboratory; 105 p.
- Keppeler, E.T.; Ziemer, R.R.; Cafferata, P.H. 1994. **Changes in soil moisture and pore pressure after harvesting a forested hillslope in northern California.** In: Marston, R.A.; Hasfurther, V.R., eds. Effects of human-induced changes on hydrologic systems; 1994 June 26-29; Jackson Hole, WY. Herndon, VA: American Water Resources Association; 205-214.
- Keppeler, E.T., Hydrologist, USDA Forest Service, Pacific Southwest Research Station, Fort Bragg, California. [E-mail to author regarding erosion sources and Class III channels]. 19 May 1997.
- Keppeler, E.T., Hydrologist, USDA Forest Service, Pacific Southwest Research Station, Fort Bragg, California. [E-mail to author regarding cumulative watershed effects in DOL watershed]. 30 Apr 1998.
- Keppeler, E.T., Hydrologist, USDA Forest Service, Pacific Southwest Research Station, Fort Bragg, California. [Telephone conversation with author regarding measurement of sheet erosion]. 4 May 1998.
- Lewis, J. 1996. **Turbidity-controlled suspended sediment sampling for runoff-event load estimation.** Water Resources Research 32(7): 2299-2310.

- Lewis, J.; Keppeler, E.T.; Mori, S.R.; Ziemer, R.R. 1998. **Cumulative impacts of clearcut logging on storm peak flows, flow volumes and suspended sediment loads.** Unpublished draft supplied by author.
- Lewis, J.; Rice, R.M. 1990. **Estimating erosion risk on forest lands using improved methods of discriminant analysis.** *Water Resources Research* 26(8): 1721-1733.
- Lisle, T.E. 1989. **Sediment transport and resulting deposition in spawning gravels, north coastal California.** *Water Resources Research* 25(6): 1303-1319.
- Lisle, T.E.; Hilton, S. 1992. **The volume of fine sediment in pools: an index of sediment supply in gravel-bed streams.** *Water Resources Bulletin* 28(2): 371-383.
- McCashion, J.D.; Rice, R.M. 1983. **Erosion on logging roads in northwestern California: how much is avoidable?** *Journal of Forestry* 81(1): 23-26.
- Meehan, W.R. 1974. **Fish habitat and timber harvest in southeast Alaska.** *Naturalist* 25: 28-31.
- Napolitano, M.B. 1996. **Sediment transport and storage in North Fork Caspar Creek, Mendocino County, California: water years 1980-1988.** Arcata, CA: Humboldt State University; 148 p. M.S. thesis.
- Newcombe, C.P.; MacDonald, D.D. 1991. **Effects of suspended sediments on aquatic ecosystems.** *North American Journal of Fisheries Management* 11: 72-82.
- O'Loughlin, C.; Ziemer, R.R. 1982. **The importance of root strength and deterioration rates upon edaphic stability in steepland forests.** In: Proceedings of I.U.F.R.O. Workshop P.1.07-00 Ecology of subalpine ecosystems as a key to management; 1982 August 2-3: Corvallis, Oregon; 70-78.
- Rice, R.M. 1996. **Sediment delivery in the North Fork of Caspar Creek.** Final Report. Agreement CA94077, California Department of Forestry and Fire Protection, Sacramento, California.
- Rice, R.M.; Datzman, P.A. 1981. **Erosion associated with cable and tractor logging in northwestern California.** In: Davies, T.R.H.; Pearce, A.J., eds. Erosion and sediment transport in Pacific Rim steeplands, Proceedings of the Christchurch Symposium, 1981 January, Christchurch, New Zealand. International Association of Hydrological Sciences Publication No. 132. Wallingford, UK: IAHS; 362-374.
- Rice, R.M.; Lewis, J. 1991. **Estimating erosion risks associated with logging and forest roads in northwestern California.** *Water Resources Bulletin* 27(5): 809-817.
- Rice, R.M.; Tilley, F.B.; Datzman, P.A. 1979. **A watershed's response to logging and roads: South Fork of Caspar Creek, California 1967-1976.** Res. Paper PSW-146. Berkeley, CA: Pacific Southwest Forest and Range Experiment Station, Forest Service, U.S. Department of Agriculture; 12 p.
- Rieger, W.A.; Olive, L.J. 1984. **The behaviour of suspended sediment concentrations during storm events.** In: Loughran, R.J., compiler. Drainage basin erosion and sedimentation; 1984 May 14-17; University of Newcastle, N.S.W.; 121-126.
- Swanson, F.J.; Dyrness, C.T. 1975. **Impact of clearcutting and road construction on soil erosion by landslides in the western Cascade Range, Oregon.** *Geology* 3(7): 393-396.
- Thomas, R.B. 1985. **Estimating total suspended sediment yield with probability sampling.** *Water Resources Research* 21(9): 1381-1388.
- Thomas, R.B. 1988. **Monitoring baseline suspended sediment in forested basins: the effects of sampling on suspended sediment rating curves.** *Hydrological Sciences Journal* 33(5): 499-514.
- Thomas, R.B. 1989. **Piecewise SALT sampling for estimating suspended sediment yields.** Gen. Tech. Rep. PSW-114. Berkeley, CA: Pacific Southwest Forest and Range Experiment Station, Forest Service, U.S. Department of Agriculture; 11 p.
- U.S. Department of the Interior. 1981. **Watershed rehabilitation plan: Redwood National Park, California.** Denver, CO: National Park Service, Denver Service Center; 65 p.
- Walling, D.E.; Webb, B.W. 1988. **The reliability of rating curve estimates of suspended sediment yield: some further comments.** In: Bordas, M.P.; Walling, D.E., eds. Sediment budgets, proceedings of the Porto Alegre Symposium; 1988 December 11-15; Brazil. International Association of Hydrological Sciences Publication No. 174. Wallingford, UK: IAHS; 337-350.
- Wilson, A.L. 1978. **When is the Chow test UMP?** *The American Statistician* 32(2): 66-68.
- Ziemer, R.R. 1968. **Soil moisture depletion patterns around scattered trees.** Res. Note PSW-166. Berkeley, CA: Pacific Southwest Forest and Range Experiment Station, Forest Service, U.S. Department of Agriculture; 13 p.
- Ziemer, R.R. 1981. **The role of vegetation in the stability of forested slopes.** In: Proceedings of the International Union of Forestry Research Organizations, XVII World Congress, volume 1; 1981 September 6-17; Kyoto, Japan. Vienna, Austria: International Union of Forestry Research Organizations; 297-308.
- Ziemer, R.R. 1992. **Effect of logging on subsurface pipeflow and erosion: coastal northern California, USA.** In: Walling, D.E.; Davies, T.R.; Hasholt, B., eds. Erosion, debris flows and environment in mountain regions, Proceedings of the Chendu symposium; 1992 July 5-9; Chendu, China. International Association of Hydrological Sciences Publication No. 209. Wallingford, UK: IAHS; 187-197.

Buffering the Buffer¹

Leslie M. Reid² and Sue Hilton³

Abstract: Riparian buffer strips are a widely accepted tool for helping to sustain aquatic ecosystems and to protect downstream resources and values in forested areas, but controversy persists over how wide a buffer strip is necessary. The physical integrity of stream channels is expected to be sustained if the characteristics and rates of tree fall along buffered reaches are similar to those in undisturbed forests. Although most tree-fall-related sediment and woody debris inputs to Caspar Creek are generated by trees falling from within a tree's height of the channel, about 30 percent of those tree falls are triggered by trees falling from upslope of the contributing tree, suggesting that the core zone over which natural rates of tree fall would need to be sustained is wider than the one-tree-height's-width previously assumed. Furthermore, an additional width of "fringe" buffer is necessary to sustain appropriate tree-fall rates within the core buffer. Analysis of the distribution of tree falls in buffer strips and un-reentered stream-side forests along the North Fork of Caspar Creek suggests that rates of tree fall are abnormally high for a distance of at least 200 m from a clearcut edge, a distance equivalent to nearly four times the current canopy height. The appropriate width of fringe buffer needed to protect the core zone will need to be determined using an analysis of the long-term effects and significance of accelerated tree-fall rates after logging.

Riparian buffer strips provide an efficient and widely accepted way to help protect aquatic ecosystems and downstream values from the effects of upslope land-use activities. Buffer strips are also the focus of a major controversy concerning the appropriate balance between rights and responsibilities, between resource extraction and resource protection. The question at the center of the controversy: how wide should a buffer strip be? Here we first discuss the roles intended for riparian buffer strips and then describe preliminary results of a study that examines the stability of riparian buffer strips.

The Role of Riparian Buffers

Riparian buffer strips are intended to allow natural interactions between riparian and aquatic systems to be sustained, thus providing some assurance that appropriate in-stream ecosystems, sediment regimes, and channel forms can be maintained. Specific roles of riparian zones—and particularly of riparian trees—with respect to the in-stream environment include:

- Maintenance of the aquatic food web through provision of leaves, branches, and insects
- Maintenance of appropriate levels of predation and competition through support of appropriate riparian ecosystems
- Maintenance of water quality through filtering of sediment, chemicals, and nutrients from upslope sources
- Maintenance of an appropriate water temperature regime through provision of shade and regulation of air temperature and humidity
- Maintenance of bank stability through provision of root cohesion on banks and floodplains
- Maintenance of channel form and in-stream habitat through provision of woody debris and restriction of sediment input
- Moderation of downstream flood peaks through temporary upstream storage of water
- Maintenance of downstream channel form and in-stream habitat through maintenance of an appropriate sediment regime

Riparian zones thus are important to adjacent in-stream ecosystems because they strongly control the availability of food, distribution of predators, form of channels, and distribution of stream temperatures (Murphy and Hall 1981, Naiman and Sedell 1979, Theurer and others 1985, Zimmerman and others 1967). They are important for downstream environments because they regulate the type and amount of sediment coming from upslope and upstream, moderate downstream flood peaks, and provide organic material for downstream channels (Masterman and Thorne 1992, Trimble 1957, Vannote and others 1980).

Of these roles, that of maintaining appropriate channel form is particularly important both for sustaining aquatic ecosystems and for controlling off-site impacts. Large woody debris is a critical physical component of forestland channels because it traps sediment and dissipates flow energy. In the smallest channels, woody debris can stabilize landslide debris, store sediment, and provide "check-dams" to prevent gullyng. In larger channels, wood can trigger the accumulation of spawning gravel, create backwaters, and cause pools to form. The ability of woody debris to perform these roles is influenced strongly by the input rate, species composition, and size distribution of in-falling trees. As these characteristics deviate from natural values, channel form—and, therefore, in-stream habitat—will change to reflect the altered

¹ An abbreviated version of this paper was presented at the Conference on Coastal Watersheds: The Caspar Creek Story, May 6, 1988, Ukiah, California.

² Research Geologist, USDA Forest Service Pacific Southwest Research Station, Redwood Sciences Laboratory, 1700 Bayview Dr., Arcata, CA 95521

³ Hydrologic Technician, USDA Forest Service Pacific Southwest Research Station, Redwood Sciences Laboratory, 1700 Bayview Dr., Arcata, CA 95521

woody debris regime (Lisle and Napolitano, these proceedings).

From a policy point of view, riparian buffer strips are important because they are a demonstrably successful means of protecting in-stream ecosystems (Davies and Nelson 1994, Erman and others 1977, Murphy and others 1986). Their importance stems from an awkward truth about aquatic ecosystems: these systems are complicated. It has become clear over the past several decades that the more an aquatic ecosystem is studied, the more is discovered about previously unrecognized critical habitat needs. Thirty years ago we did not understand the importance of large woody debris; 20 years ago we were ignorant of the need for off-channel rearing and refuge habitat for salmonids. We can thus assume that we do not yet know everything about the habitat and ecosystem characteristics needed for the survival of coho salmon and other aquatic species. Given this level of uncertainty, it is necessary to maintain a habitat system that functions similarly to that in which a species evolved if that species is to be sustained. If a riparian buffer strip is wide enough to ensure that a channel system does not receive biological and physical signals that upslope conditions have changed, the aquatic system is likely to be capable of providing the habitat and resources required to sustain its full complement of species.

The Forest Ecosystem Management Assessment Team report (FEMAT 1993) describes the need for this ecosystem-based strategy for species conservation: "...any species-specific strategy aimed at defining explicit standards for habitat elements would be insufficient for protecting even the targeted species. To succeed, any...[s]trategy must strive to maintain and restore ecosystem health at watershed and landscape scales." FEMAT thus advocated the establishment of riparian reserves to help sustain the proper functioning of processes that influence habitat, and thus to provide for both known and as-yet-unknown habitat requirements for coho and other aquatic species. FEMAT recommendations were incorporated into the Northwest Forest Plan (USDA and USDI 1994), which applies to federal lands in the Pacific Northwest. A report prepared for the National Marine Fisheries Service (Spence and others 1996; known as the "ManTech report") makes similar recommendations for the design of Habitat Conservation Plans on non-federal lands in the same area.

The width of riparian strip needed to fulfill each of the roles listed above depends on the kind of riparian community present, the type of stream, and the role in question. Appropriate widths often are reported in terms of the height of trees that would grow in the zone under natural conditions. In the case of the FEMAT report, this "site potential tree height" is defined as "the average maximum height of the tallest dominant trees (200 years or older) for a given site class." Under the Northwest Forest Plan, prescribed buffer widths for fish-bearing streams are a minimum of two tree heights' width, while the ManTech report concludes that buffers equal to or greater than one tree height's width are necessary, depending on which riparian functions are to be maintained. Similarly, the Sierra Nevada Ecosystem Project's discussion of riparian needs recommends a minimum of a one-tree-height buffer (Kondolf and others 1996). All of these recommendations specify that management activities such as logging and road-building are to be avoided within riparian zones unless those activities are compatible

with the restoration and preservation of appropriate riparian and aquatic function.

Although there thus appears to be some consensus among the technical and scientific communities about riparian protection needs in support of aquatic ecosystems, controversy continues because of the implications of such protection for resource extraction opportunities. In a terrain with a stream density of 3 km/km², 15 percent fish-bearing channels, and a 50-m site-potential tree height, Northwest Forest Plan riparian reserve areas for fish-bearing streams would account for approximately 8 percent of the area, and lesser requirements for non-fish-bearing streams would represent an additional 20 to 25 percent. Buffer strips would thus occupy a substantial portion of the landscape. The rationale for requiring buffer strips must be well-founded if such prescriptions are to be willingly followed.

Both the FEMAT and ManTech reports distinguish between buffer-strip widths necessary to sustain the physical stream environment and those needed to sustain near-channel microclimate and appropriate riparian communities. Both reports note that trees farther than one tree height from the stream are unlikely to contribute wood or sediment to the stream, so the physical integrity of the stream system is likely to be sustained if appropriate tree-fall characteristics and rates are maintained within a buffer strip of width equivalent to one tree height. Both also note that the microclimatic conditions that strongly influence riparian communities and affect stream temperatures are potentially influenced by altered conditions to a distance of two to three tree heights from the edge of the buffer strip. The strategies thus call for maintenance of an essentially undisturbed vegetation community within one or more tree-heights' distance from perennial or fish-bearing streams. The ManTech report further indicates that an extra width of buffer may be needed to protect this core buffer from accelerated mortality due to the presence of the edge.

Approach

The goal of the study described here was to evaluate the influence of a newly established forest edge on rates of sediment and woody debris input to a stream channel. This information might then be used to evaluate the width of riparian buffer strip needed to sustain the physical functioning of the channel system.

Studies in Oregon (McDade and others 1990, VanSickle and Gregory 1990) and Alaska (Murphy and Koski 1989) demonstrate the relative importance of in-falling trees as a function of distance from a channel: trees near the stream have a much greater likelihood of introducing woody debris than do those farther away (*fig. 1*). Because introduction of woody debris disturbs banks and diverts channel flows, in-channel erosion is likely to be modified by in-fall, and the sediment input triggered by this source is likely to vary with distance from the channel in the same way as input of woody debris. The first objective of this study was to define variations in wood and sediment input to channels as a function of the distance of the source tree from the channel.

Along the outer edge of the buffer, the most exposed trees are expected to be most susceptible to windthrow, microclimatic stress,

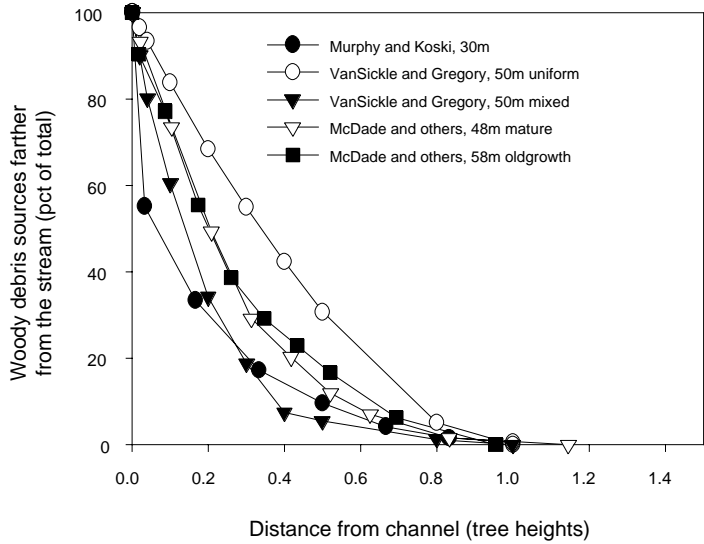

Figure 1—Location of woody debris sources with respect to channel edges. Measurements by Murphy and Koski (1989) were reported by Spence and others (1996) to have been from a forest with a 30-m canopy height; results from VanSickle and Gregory (1990) are modeled; results from McDade and others (1990) are from field measurements.

damage by felling and yarding of nearby trees, and insect infestation and disease associated with increased stress and damage. Farther into the stand, lesser exposure is expected to decrease the probability of mortality until, at some distance, mortality rates would reapproach those characteristic of the interiors of undisturbed stands. It is possible, also, that mortality rates would then increase again near channels in both disturbed and undisturbed stands as a result of channel erosion, seasonally saturated soils, increased prevalence of shorter-lived riparian hardwoods, and locally steep banks associated with inner gorges. A second objective of this study thus was to define the relation between tree-fall mortality and distance from a riparian buffer edge.

Buffer widths appropriate for sustaining the physical characteristics of the stream channel then could be designed using these two kinds of information. The minimum width of the core buffer could be selected as the maximum distance from which tree-fall sediment and debris enter the stream (*fig. 2*), and the minimum width of the fringe buffer would be the distance over which edge effects influence rates of tree fall inside a stand (*fig. 2*). The final objective of the study was to use the results of the first two objectives to estimate core and fringe buffer widths that would be capable of sustaining an appropriately functioning riparian buffer that is itself capable of maintaining an appropriately functioning physical stream environment.

The Field Site

Field work was carried out in the 3.8-km² North Fork Caspar Creek watershed above the Arfstein gauging station on the Jackson

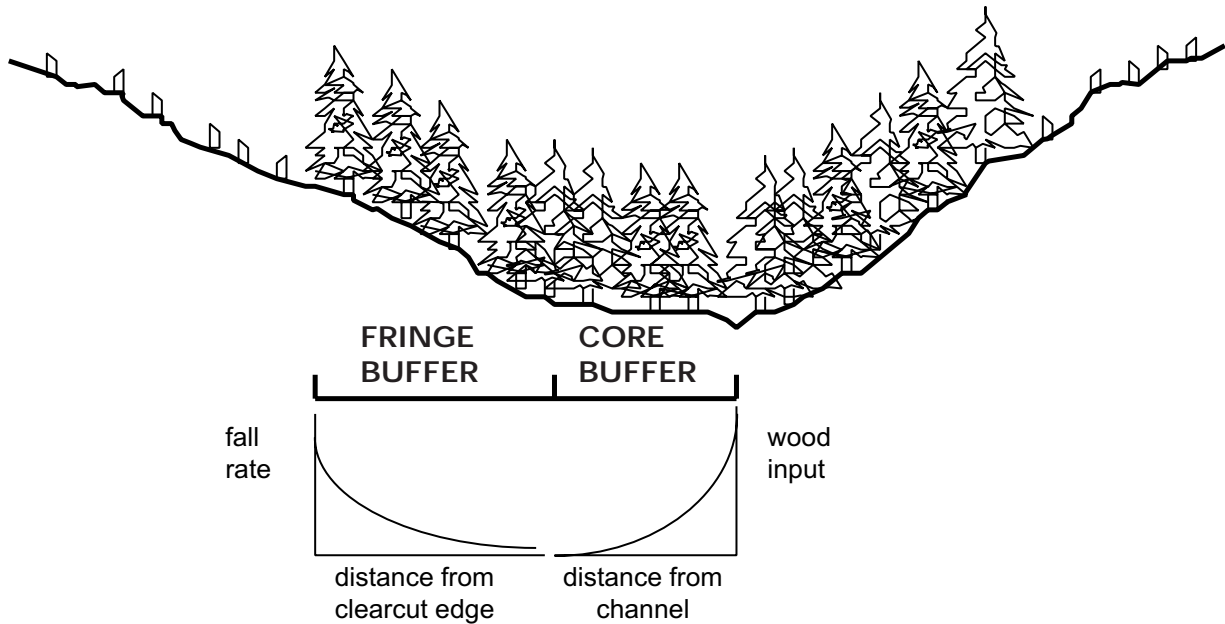

Figure 2—Hypothetical example of “core” and “fringe” buffer zones intended to sustain the physical integrity of the channel system. The core zone extends from the channel to the maximum distance of sediment or wood input from falling trees, and the fringe zone extends beyond the core far enough to maintain appropriate tree-fall rates within the core zone.

Demonstration State Forest, Mendocino County, California (fig. 3). The watershed is underlain by Cretaceous to Oligocene sandstones and shales of the Franciscan assemblage, on which are developed loam soils which typically have depths of 50 to 200 cm. Drainage density is about 4 km/km², and portions of the streams are inset into locally developed inner gorges. Valley-bottom width along the mainstem channel generally ranges between 5 and 15 m, and, where developed, inner gorge slopes have slope-lengths of about 40 to 100 m and gradients of 30° to 40°. Hillslopes beyond the inner gorge range in gradient between 15° and 30° with a maximum slope length of about 350 m.

Rainfall in the area averages about 1200 mm/yr, and 90 percent of the annual precipitation falls during October through April. Snow is uncommon. Rain falls primarily during frontal storms of one or more days' duration, and rain is ordinarily preceded by periods of high-velocity southerly to south-westerly winds. Major tree-fall events are associated with these winter storms.

The original forest was dominated by coastal redwood (*Sequoia sempervirens*), Douglas-fir (*Pseudotsuga menziesii*), and grand fir (*Abies grandis*); tanoak (*Lithocarpus densiflorus*) would have been present in the understory. Most of the watershed was first clearcut and burned between 1864 and 1900 (Henry, these proceedings; Napolitano, these proceedings). The second-growth forest is thus on the order of 90 to 130 years old, and consists of natural regeneration of the original species. About 55 percent of the stems greater than 15 cm in diameter are redwood, 26 percent Douglas-fir, 10 percent tanoak, and 5 percent grand fir. About 61 percent are less than 0.5 m in diameter, and 7 percent are greater than 1 m. Many of the original redwoods resprouted from stumps, forming clumps of young redwoods surrounding the original boles. Land in the area is considered to be of site class II for redwood, indicating

that 100-year-old redwoods are expected to be 47 to 55 m high (CDF 1998). Measured lengths of fallen canopy trees indicate that average canopy height is currently about 50 to 60 m.

The second cycle of logging began in 1989 under a protocol designed for a cumulative effects experiment (Henry, these proceedings). About 43 percent of the watershed was clearcut over a 3-year period in blocks of 9 to 60 ha. Stream-side buffer zones 30 to 60 m wide (a distance equal to approximately 0.5 to 1 tree heights) were left along the mainstem channel. About 35 percent of the volume of standing wood was removed selectively from the outer portion of these strips, with the trees selected for removal being those either expected to have a high probability of falling or those at an optimum condition for wood production. Few if any trees were removed from within 15 m of the channel. Storms occurred during the winters of 1990, 1994, and 1995 that were associated with high rates of tree fall.

Methods

The study was conducted in three phases. First, all trees that had fallen or snapped since logging were counted in 10 sections of buffer strip and four uncut sample plots along the North Fork of Caspar Creek (fig. 3, table 1). One of the uncut plots was opposite a cut unit; the others were not. One buffer-strip plot was located on an old landslide scar, and another occupied a floodplain formed by infilling behind an old splash dam. Plots were selected to have similar orientations relative to the prevailing southerly direction of storm winds. Study plots ranged from 63 to 202 meters in length along the channel and extended to the edge of the buffer strip or, if uncut, to a 60-m slope distance from the channel. Surveys were conducted from March 1994 through May 1995, with plots associated with the

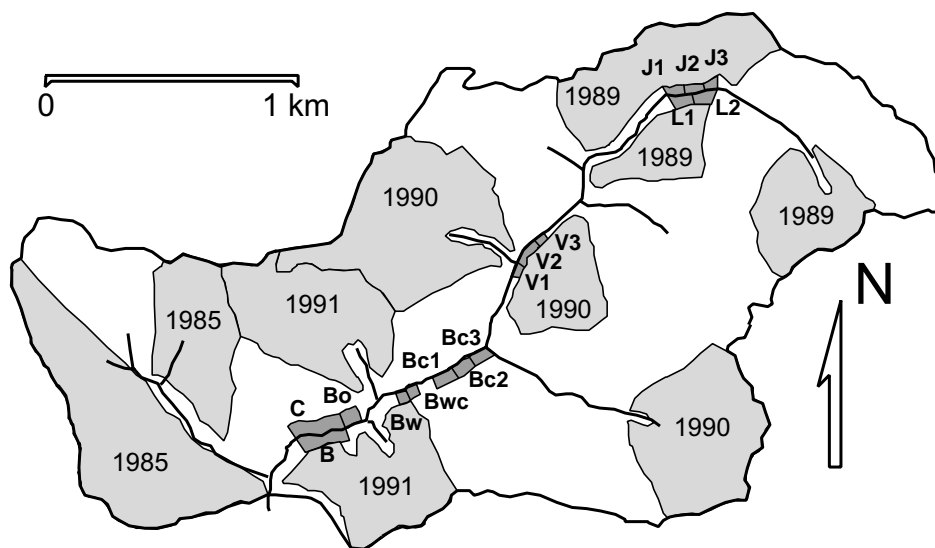

Figure 3—Location of the North Fork Caspar Creek tree-fall study plots, showing clearcut unit boundaries, year cut, study plots, and plot names. See table 1 for plot descriptions. Plot JL is located on the floodplain between the J plots and the L plots.

Table 1—Plot descriptions

Plot	Class	Area (ha)	Original trees/ha	Cut age	Pct. vol. cut	Original standing live trees	Thrown live trees	Snapped live trees	Pct. dead	Original standing snags	Downed snags	Meters from edge ²	Method ¹
Bwc	Uncut	0.56	255	None	0	144	2	2	2.78	31	9	48	2
Bc1	Uncut	0.43	308	None	0	132	2	0	1.52	19	1	176	1,2
Bc2	Uncut	0.47	301	None	0	141	1	0	0.71	18	7	264	1,2
Bc3	Uncut	0.47	340	None	0	159	1	1	1.26	12	1	188	1,2
Bo	Opposite	0.48	434	1991	0	206	13	1	6.80	10	2	88	2
C	Opposite	1.21	345	1991	0	418	9	1	2.39	—	0	88	1
B	Buffer	1.21	266	1991	31	322	34	4	11.8	—	13	28	1
Bw	Buffer	0.19	258	1991	31	50	1	3	8.00	10	1	28	2
V1	Buffer	0.38	274	1990	22	103	5	1	5.83	8	3	16	1,2
V2a ³	Buffer	0.14	388	1990	0	47	3	0	6.38	6	1	38	2
V2b ⁴	Buffer	0.28	242	1990	33	68	12	1	19.1	—	1	15	1
V3 ⁵	Buffer	0.19	457	1990	<22	86	25	1	30.2	9	9	20	1,2
J1	Buffer	0.31	361	1989	35	112	3	1	3.57	7	6	13	1,2
J2	Buffer	0.24	413	1989	35	98	5	1	6.12	16	9	12	1,2
J3	Buffer	0.40	238	1989	35	95	4	1	5.26	4	3	18	1,2
L1	Buffer	0.33	345	1989	38	115	14	3	14.8	4	2	18	1,2
L2	Buffer	0.33	201	1989	38	66	12	0	18.2	5	3	19	1,2
JL ⁶	Buffer	0.45	55	1989	0	25	1	0	4.00	0	0	40	1,2

¹1: Original survey; 2: stand map

²Distance between edge of clearcut and center of plot

³Only the portion of the buffer within 15 m of the channel was mapped

⁴This portion of the buffer strip includes only the area of the original survey that was not mapped later

⁵Located on an old landslide

⁶Located on a floodplain created by a splash-dam

earliest logging being surveyed first. Plots originally surveyed in 1994 were resurveyed in 1995, so all surveys included all downed trees as of May 1995.

For each downed tree, a live control tree was selected at approximately the same distance from the bank by pacing a random number of paces upstream or downstream along the contour and choosing the nearest live tree. Data collected for each tree include species, diameter at breast height, damage class (snapped, thrown, or control), fall direction, whether the tree was dead when thrown or broken, estimated time since damage, distance to stream channel, distance to buffer-strip margin (if present), amount and type of wood input into the stream channel, amount of soil input to the stream channel, and the presence of factors that might be expected to increase the probability of a tree being thrown or broken. Possible contributing factors included seasonally saturated soils, steep slopes, root rot, whether a redwood was part of a sprout clump, bank and slope failures, logging damage, damage from another falling tree, and nearby road or trail construction.

Time since damage was known for most trees that fell in 1995 and for some trees that had fallen close to the channel in 1992 and 1993. For other trees, age was estimated from root sprouts or other vegetative evidence, or the tree was classified into one of five decay classes according to the condition of its foliage and branches: (1) green leaves or needles present, (2) dead leaves or needles present, (3) leaves gone but small twigs present, (4) small twigs gone but branches present, and (5) branches gone or bark sloughing off. Additional evidence, such as the age of vegetation on or around the

root-wad, was used to eliminate trees that had fallen more than 5 years before the surveys. The decay classes were converted to approximate years since damage on the basis of comparison to fallen trees for which dates of fall were known by either direct observation or vegetative evidence.

The second study phase was carried out between May 1994 and December 1995. All standing and recently downed trees were mapped using a survey laser in 12 of the original survey plots (nine buffer zones and three controls) and in three additional plots, two in un-reentered stands and one in a small section of buffer (*fig. 3, table 1*). Species, diameter, condition (live, snag, snapped when living, snapped snag, thrown), distance from channel, and distance from clearcut edge were recorded for each tree. The channel edge was also mapped, and the outer edge of the selectively logged buffer zone was defined as a line connecting the outermost trees at approximately 20-m intervals. The first two phases of the study together characterized tree falls representing a 6-year period.

A storm in December 1995 resulted in abnormally severe blowdown in the study area and provided an opportunity to collect an additional set of data for the third phase of the study. All trees were counted that were felled by the storm and contributed wood or sediment to the channel along 3 km of the mainstem of North Fork Caspar Creek. Each tree was characterized by species, diameter, sediment input, wood input, distance along the channel, distance from the channel, whether it was alive or dead when it fell, and whether it was hit by another tree. Trees felled by the December storm were not included in data sets from the other phases of the study.

Results and Discussion

Comparison of the populations of standing and fallen trees in the uncut study plots suggests that tanoak is the most susceptible species to tree fall, while redwood falls at a lower than average rate. Fall rates are distributed approximately according to the proportional representation of size classes. Data from the post-storm channel survey show no statistically significant differences in the species or size distribution between trees that entered the channel from buffer strips and those from un-reentered forest.

Two styles of tree fall were evident. Most common is failure of individual trees, which then may topple others as they fall. However, the sequence of storms since logging progressively contributed to extreme rates of tree fall in at least four locations in the watershed, suggesting the possibility that high-intensity wind eddies may have locally severe effects. In each of these cases, the area of concentrated blowdown was located within about 150 m of a clearcut margin. None of these sites were included in the sampled plots.

Most tree fall occurred by uprooting, with only 13 percent of failures caused by snapping of boles. Failure by snapping was particularly common among grand fir, but both Douglas-fir and redwood were also susceptible. The majority of trees fell downslope even when the downslope direction was opposite the direction of prevailing storm winds.

Measurements from the long-channel survey indicate that fallen trees influenced the stream channel by introducing woody debris from as far as 40 m from the channel in un-reentered forests and 70 m along buffer strips (*fig. 4*). About 90 percent of the instances of debris input occurred from falls within 35 m of the channel in un-reentered forests and within 50 m of the channel in buffer strips. The pattern for un-reentered forests approximately follows the distributions measured by McDade and others (1990) for mature and old-growth forests (*fig. 1*). However, the distribution predicted by VanSickle and Gregory (1990) for a mixed-age conifer forest (*fig. 1*) underrepresents the observed importance of trees falling from greater distances. This discrepancy is probably due to the observed tendency of Caspar Creek trees to fall downslope, whereas the modeling exercise assumed a random distribution of tree-fall directions (VanSickle and Gregory 1990). The distribution of source distances observed for buffer strips at Caspar Creek demonstrates higher rates of input at greater distances than measured or modeled previously, possibly reflecting the combined effects of high tree-fall rates in the selectively logged portion of the buffers and the predominantly downslope orientation of falls.

Tree falls were triggered by another falling tree in about 30 percent of the surveyed cases. Thus, even though the width of the zone of direct influence to the channel is a distance approximately equal to a tree's height, the importance of secondary tree falls expands the width of buffer strip required to maintain the physical integrity of the channel. The distribution of input sources was thus recalculated to account for the influence of trigger-trees (*fig. 4*).

Influences of tree fall on sediment inputs to the channel are of three types: direct input from sediment transport by uprooting, direct input from the impact of the falling tree on channel banks, and indirect input from modification of channel hydraulics by wood

in the channel. At low to moderate rates of debris loading, sediment input from the latter source is expected to be proportional to the amount of woody debris introduced to the channel. Sediment input from root-throw depends strongly on the proximity of the tree-throw mound to the channel. In general, only those uprooted trees originally located within a few meters of the channel contributed sediment from rootwads. Observations after the 1995 storm suggest that 90 percent of the sediment introduced directly by tree fall in the un-reentered forested reaches originated from within 15 m of the channel, while in buffer strips, sediment was introduced by trees falling from considerably farther away (*fig. 5*). Rates of direct sediment input by tree fall during the storm were on the order of 0.1 to 1 m³ of sediment per kilometer of main-stem channel bank.

The second focus of the study was to describe the distribution of fall rates as a function of distance from a clearcut edge and to compare rates of fall in buffer strips and un-reentered forest. Total rates of woody debris input from buffer strips and un-reentered forests reflect both inherent differences in the likelihood of failure for individual trees and differences in the population of trees capable of contributing woody debris: selectively cut buffer strips have fewer trees available to fall. Failure rates thus were calculated as the average probability of failure for a living tree 15 cm in diameter or greater.

Rates of tree fall were expected to be high immediately adjacent to channels, where high flows and bank erosion might also destabilize trees. Tree-fall rates thus were calculated as a function of distance from the channel bank for both buffer strips and un-reentered forest. Results show no statistically significant increase in fall rate near the channel in either setting. Mortality rates on the

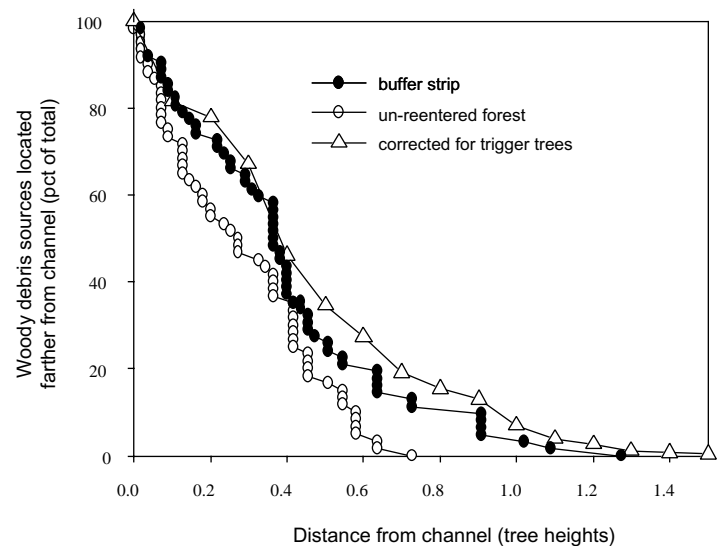

Figure 4—The distribution with respect to the channel edge of sources for woody debris inputs to North Fork Caspar Creek from buffer strips and un-reentered forest. The recalculated curve accounts for inputs from tree falls triggered by trees falling from farther upslope. An average canopy height of 55 m is assumed.

floodplain site are equivalent to those expected for other sites at similar distances from a clearcut edge.

Rates of tree fall were also expected to decrease as a function of distance from the outer edge of the buffer strip as the extent of exposure decreases. However, data indicate no clear pattern in fall distribution, and increased rates persist for the full widths of the buffer strips. In particular, excess fall rates do not consistently decrease through the width of the selectively cut portion of the buffer, suggesting that the fall rate may reflect the combined influence of the selective removal of trees and the presence of the newly exposed stand edge.

The distribution of fall rates within un-reentered stands was then examined to determine whether the influence of the clearcut boundary persisted even farther into the stands. In un-reentered stands (fig. 6, open symbols), average fall rates (R , percent downed per year) are correlated with the distance between the plot center and the nearest clearcut edge (x , meters):

$$R = 1.36e^{-0.00915x} \quad r^2 = 0.66 \quad (1)$$

That the relationship exists suggests that, of the measured rates, the most appropriate estimate of a background fall rate is that of 0.12 percent per year measured in the most isolated control plot for the 6-year study period, or about 0.4 trees per hectare per year.

However, the trend of the relation shown in figure 6 suggests that the background rate has not been fully achieved by 264 m into the stand, the distance represented by the most isolated of the study plots. The potential minimum background rate can be estimated using the assumption that the influence of a clearcut edge would not be felt beyond a ridge. Extrapolation of the relation

to estimate the failure rate at a distance of 350 m from a clearcut edge (the maximum slope length for the watershed) provides an estimated minimum of 0.06 percent mortality per year for a completely un-reentered second-growth forest. The rate measured for the 264 m plot thus is no more than about twice the minimum possible rate, and the actual difference is likely to be considerably less. The measured value of 0.12 percent thus will be assumed to be representative of background fall rates in subsequent calculations.

In any case, tree falls were identified and counted consistently in each study plot, so tree falls in excess of the expected background rate can be attributed to the inherent spatial variability of rates and to the effects of logging. Assuming that spatial variability is randomly distributed, calculated excess tree falls for each plot can be divided by the number of years since logging to estimate the average annual rate of tree fall induced by nearby logging. Results for buffer strips (exclusive of the landslide and floodplain sites) show an average annual total fall rate (including both excess and background rates) of 1.9 ± 0.7 percent for the period since logging, or about 3 to 7 trees per hectare per year. Comparison of rates between buffer plots and the most isolated control plot suggests that the probability of failure for a tree in a buffer strip is approximately an order of magnitude higher than that for trees in the un-reentered second-growth redwood forest.

Equation (1) provides an expected annual fall rate of 1.1 percent for the average distance-to-edge of 21 m for the buffer-strip plots. The expected average rate is about 60 percent of the measured average, again suggesting that proximity to the boundary may not be the only factor influencing the fall rates in the selectively-cut buffer strips. It is possible, for example, that opening of the buffer-strip stand by selective logging may also contribute to

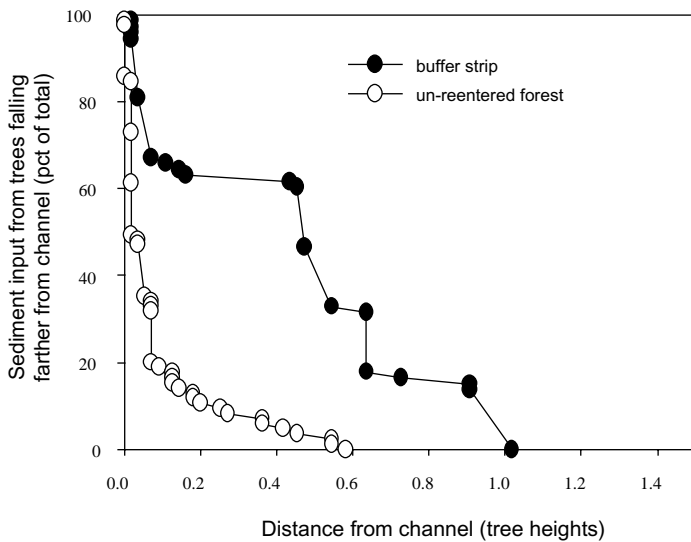

Figure 5—The distribution with respect to the channel edge of tree falls associated with sediment production to North Fork Caspar Creek from buffer strips and un-reentered forest. Sources are weighted by the approximate volume of sediment contributed. An average canopy height of 55 m is assumed.

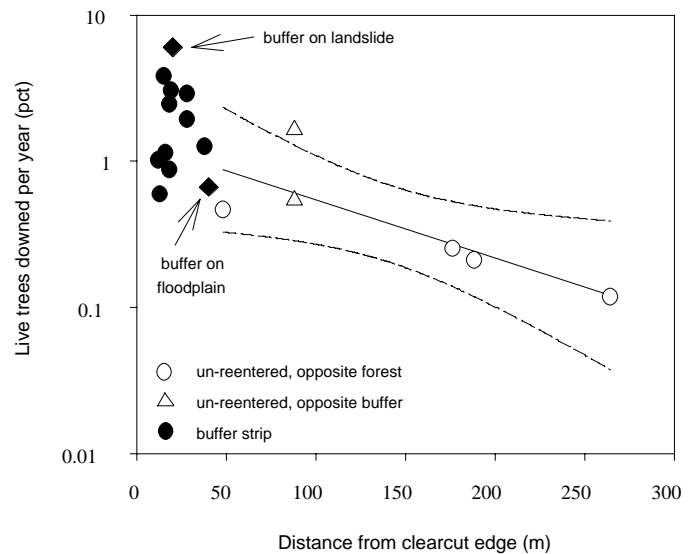

Figure 6—Probability of failure of live trees as a function of the distance between the center of each study plot and the edge of the nearest clearcut. The regression line and 95 percent confidence band are calculated for un-reentered plots (open symbols); data from buffer-strip plots are not included in the regression.

destabilization of the remaining trees.

Rates of tree fall are expected to stabilize with time after logging. Weidman (1920), for example, reports that two-thirds of the excess tree fall in selectively logged western yellow pine stands occurs within 5 years of logging, and Steinblums and others (1984) note that most excess tree fall in 40 buffer strips of the Oregon Cascades occurred during the first few years. For Caspar Creek, data from the long-channel survey allow calculation of rates of failure during a single storm that occurred 4 to 6 years after clearcutting. By this time stands had already been partially depleted of unstable trees, and remaining trees had had an opportunity to increase their wind-firmness through modification of foliage and rooting patterns. Overall instances of woody-debris input per unit length of channel during the storm generally increase slightly upstream, and rates of input were similar along uncut and buffered reaches. However, stand density at the time of the storm was significantly lower along the buffered reaches, and the probability of failure for an individual tree remains higher in buffer zones even after 4 to 6 years after cutting when stand density (*fig. 7*) and long-channel location (*fig. 8*) are accounted for. This pattern suggests that the disparity in stocking rates between buffer strips and un-reentered forests is continuing to increase.

Data from the post-storm survey also indicate that in-fall frequencies from the north bank were generally lower than those from the south bank. The pronounced tendency of trees on both north- and south-facing slopes to fall downslope suggests that the larger angle between buttressing roots and bole may provide less resistance to failure in a downslope direction. Failure may thus be most likely when strong winds blow downslope. In addition, any

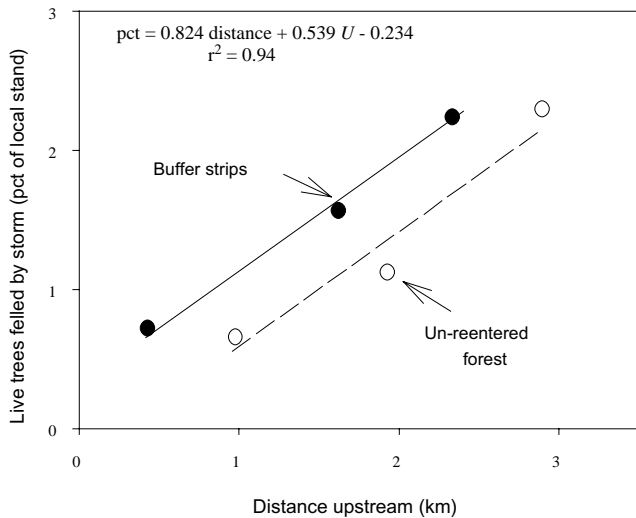

Figure 8—Tree-fall rates from the December 1995 storm in buffer strips and un-reentered forest stands along the south bank of North Fork Caspar Creek. Data from localized areas of extreme blowdown and from uncut forests opposite buffer strips are not included. The dummy variable, U, takes on a value of 0 for un-reentered forest and 1 for buffer strips.

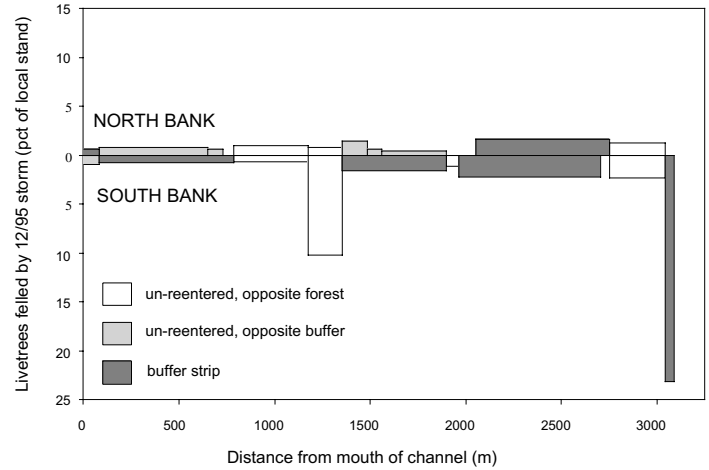

Figure 7—Distribution of tree falls along North Fork Caspar Creek during the storm of December 1995 in terms of probability of failure for a live tree. High rates at 1300 m and 3050 m represent localized concentrations of very intense blowdown, possibly reflecting the influence of localized wind eddies.

north-side trees that did fall in the direction of the major southerly storm winds would fall away from the channel and thus not be included in the post-storm survey.

In general, then, results suggest that the presence of a clearcut can at least double tree-fall rates for a distance of more than 150 m into a stand composed of 50- to 60-m-high second-growth trees (*fig. 6*). These results are consistent with results reported by Chen and others (1995), which show that wind speeds remain higher than expected for a distance of 240 m in from the edge of stands of 50- to 65-m-tall old-growth Douglas-fir forests in Washington and Oregon. The effect might be expected to be even stronger where a portion of the remaining stand has been selectively logged, as in the Caspar Creek case.

Conclusions

Results suggest that the strategy used for buffer-strip design along North Fork Caspar Creek produces an order-of-magnitude increase in the probability of failure for individual trees during the first 6 years after logging, and that a more modest increase in fall rate persists beyond 6 years. Failure rates throughout the width of the selectively logged portion of the buffers remain higher than predicted on the basis of proximity to the edge, suggesting that the increased rates in that portion may reflect both selective logging and the presence of a clearcut edge. In any case, the 30-m-wide selective cut does not protect the innermost 15 m of uncut buffer from accelerated rates of fall.

Results also suggest the need to expand the conceptual basis for defining a “core buffer” with a natural distribution of tree

species and sizes, as required to sustain the physical integrity of the stream channel. Although 96 percent of the in-falling wood is derived from within one tree-height's distance of the channel, about 30 percent of these falls resulted from trees being hit by another falling tree. Because the triggering trees could have been located at even greater distances from the channel, this pattern indicates that an additional increment of width is required to sustain the appropriate fall rate of potential trigger trees. If this additional width is not considered during the design of a fringe buffer, accelerated fall rates of marginal trigger trees would increase rates of secondary tree fall within the core zone.

How wide a buffer is wide enough? In this case, preliminary results suggest that a one-tree-height width of uncut forest that is allowed to sustain appropriate fall rates would include 96 percent of the potential woody debris sources for the channel system. Combining the pattern of source trees with the distribution of triggering tree-fall distances indicates that an additional 0.1-tree-height's width would be needed to preserve the fall rate of trigger-trees that is needed to sustain the 96 percent input rate (*fig. 4*). Beyond this, an uncut fringe-zone of 3 to 4 tree-height's width would be necessary to ensure that the fall rate within the core zone is within a factor of 2 of background rates (*fig. 6*). Thus, a total no-cut zone of at least 4 to 5 tree-heights' width would appear to be necessary if woody debris inputs are to be maintained at rates similar to those for undisturbed forested channels. Such provisions might be necessary also along property boundaries if neighboring landowners are to be protected from excessive wind damage.

However, the utility of the fringe zone is highest during the years immediately after logging because fall rates will eventually decrease as neighboring stands regrow, as marginal trees become more wind-firm, and as the most susceptible trees topple. If the early increase in fall rates attenuates rapidly and growth rates within the depleted stand increase because of the "thinning," the long-term influence of the pulse of tree fall may be relatively small. Longer-term monitoring of fall rates and stand development is necessary if the long-term significance of accelerated fall rates—and thus the level of protection needed from a fringe buffer zone—is to be assessed adequately.

At this point, results of the study are preliminary, and they reflect conditions in a single watershed. Relationships such as that shown in *figure 6* will need to be tested in other areas. Sites will also need to be monitored over a longer period. Because the partially cut buffers and nearby uncut stands now have significantly fewer standing trees than the more remote un-reentered stands, it is likely that the disturbed stands will eventually start producing less woody debris. Additional information concerning debris mobility, decay rates, stand development, and stand-age-dependent mortality could be used to model future changes in debris input, allowing assessment of future influences on channel processes.

This study's results are based on measurements made in a 50- to 60-m-tall, second-growth redwood forest. Not only do these sites not reflect the canopy height in which the local stream ecosystems developed, but they do not reflect the background rates or

characteristics of tree fall appropriate for the setting. Under natural conditions, woody debris inputs would have included pieces far larger and more decay-resistant than the current stand is capable of producing. Additional information about debris input and decay rates in natural settings could be used to compare predicted future debris regimes in the recovering system with those appropriate for the natural system in the area.

Acknowledgments

Thembi Borrás, Annie Breitenstein, Dina Ederer, Jen Feola, Amanda Jameson, Lindsey Johnston, Lex Rohn, Diane Sutherland, Chris Surfleet, and especially Jay Arnold provided indispensable assistance with fieldwork. Liz Keppeler profoundly influenced the study through her insights into the workings of the Caspar Creek environment.

References

- CDF [California Department of Forestry and Fire Protection]. 1998. **California Forest Practice Rules**. Sacramento, CA: California Department of Forestry and Fire Protection.
- Chen, Jiquan; Franklin, Jerry F.; Spies, Thomas A. 1995. **Growing-season microclimatic gradients from clearcut edges into old-growth Douglas-fir forests**. *Ecological Applications* 5(1): 74-86.
- Davies, P.E.; Nelson, M. 1994. **Relationships between riparian buffer widths and the effects of logging on stream habitat, invertebrate community composition and fish abundance**. *Australian Journal of Marine and Freshwater Research* 45: 1289-1305.
- Erman, D.C.; Newbold, J.D.; Roby, K.B. 1977. **Evaluation of streamside bufferstrips for protecting aquatic organisms**. Contribution 48. Davis, CA: California Water Resources Center, University of California.
- FEMAT [Forest Ecosystem Management Assessment Team]. 1993. **Forest ecosystem management: an ecological, economic, and social assessment**. Report of the Forest Ecosystem Management Assessment Team. 1993-793-071. U.S. Government Printing Office.
- Kondolf, G. Mathias; Kattelmann, Richard; Embury, Michael; Erman, Don C. 1996. **Status of riparian habitat**. In: Sierra Nevada Ecosystem Project: Final report to Congress, vol. II, Assessments and scientific basis for management options. Wildland Resources Center Report no. 37. Davis, CA: University of California, Centers for Water and Wildland Resources; 1009-1030.
- Masterman, R; Thorne, C.R. 1992. **Predicting influence of bank vegetation on channel capacity**. *Journal of Hydraulic Engineering* 118(7): 1052-1058.
- McDade, M.H.; Swanson, F.J.; McKee, W.A.; Franklin, J.F.; VanSickle, J. 1990. **Source distances for coarse woody debris entering small streams in western Oregon and Washington**. *Canadian Journal of Forest Research* 20: 326-330.
- Murphy, M.L.; Hall, J.D. 1981. **Varied effects of clear-cut logging on predators and their habitat in small streams of the Cascade Mountains, OR**. *Canadian Journal of Fisheries and Aquatic Sciences* 38: 137-145.
- Murphy, M.L.; Heifetz, J.; Johnson, S.W.; Koski, K V.; Thedinga, J.F. 1986. **Effects of clear-cut logging with and without buffer strips on juvenile salmonids in Alaskan streams**. *Canadian Journal of Fisheries and Aquatic Sciences* 43(8): 1521-1533.
- Murphy, M.L.; Koski, K V. 1989. **Input of woody debris in Alaska streams and implications for streamside management**. *North American Journal of Fisheries Management* 9: 427-436.
- Naiman, R.J.; Sedell, J.R. 1979. **Relationships between metabolic parameters and stream order in Oregon**. *Canadian Journal of Fisheries and Aquatic Science* 37: 834-847.

- Spence, Brian C.; Lomnický, Gregg A.; Hughes, Robert M.; Novitzki, Richard P. 1996. **An ecosystem approach to salmonid conservation**. TR-4501-96-6057. Corvallis, OR: ManTech Environmental Research Services Corporation.
- Steinblums, I.J.; Froehlich, H.A.; Lyons, J.K. 1984. **Designing stable buffer strips for stream protection**. *Journal of Forestry* 82: 49-52.
- Theurer, F.D.; Lines, I.; Nelson, T. 1985. **Interaction between riparian vegetation, water temperature, and salmonid habitat in the Tucannon River**. *Water Resources Bulletin* 21(1): 53-64.
- Trimble, G.R. 1957. **How far from a stream should a logging road be located?** *Journal of Forestry* 55: 339-341.
- USDA and USDI [United States Department of Agriculture and United States Department of the Interior]. 1994. **Record of Decision for amendments to Forest Service and Bureau of Land Management planning documents within the range of the northern spotted owl; Standards and Guidelines for management of habitat for late-successional and old-growth forest related species within the range of the northern spotted owl**. 1994 - 589-111/00001. Region 10: U.S. Government Printing Office.
- Vannote, R.L.; Minshall, G.W.; Cummins, K.W.; Sedell, J.R.; Cushing, C.E. 1980. **The river continuum concept**. *Canadian Journal of Fisheries and Aquatic Sciences* 37: 130-137.
- VanSickle, J.; Gregory, S.V. 1990. **Modeling inputs of large woody debris to streams from falling trees**. *Canadian Journal of Forest Research* 20(10): 1593-1601.
- Weidman, R.H. 1920. **A study of windfall loss of western yellow pine in selection cuts 15-30 years old**. *Journal of Forestry* 18: 616-622.
- Zimmerman, R.C.; Goodlett, J.C.; Comer, G.H. 1967. **The influence of vegetation on channel form of small streams**. *International Association of Hydrological Sciences Publication* 75: 255-275.

Effects of Recent Logging on the Main Channel of North Fork Caspar Creek¹

Thomas E. Lisle² and Michael B. Napolitano³

Abstract: The response of the mainstem channel of North Fork Caspar Creek to recent logging is examined by time trends in bed load yield, scour and fill at resurveyed cross sections, and the volume and fine-sediment content of pools. Companion papers report that recent logging has increased streamflow during the summer and moderate winter rainfall events, and blowdowns from buffer strips have contributed more large woody debris. Changes in bed load yield were not detected despite a strong correlation between total scour and fill and annual effective discharge, perhaps because changes in stormflows were modest. The strongest responses are an increase in sediment storage and pool volume, particularly in the downstream portion of the channel along a buffer zone, where large woody debris (LWD) inputs are high. The association of high sediment storage and pool volume with large inputs of LWD is consistent with previous experiments in other watersheds. This suggests that improved habitat conditions after recent blowdowns will be followed in future decades by less favorable conditions as present LWD decays and input rates from depleted riparian sources in adjacent clearcuts and buffer zones decline.

North Fork Caspar Creek (NFCC) provides a rare opportunity to observe the effects of altered inputs of all of the important watershed products (water, sediment, and woody debris) to which forested stream channels respond after logging. Understanding the effects of recent experimental logging requires first an understanding of the background influences of basin geomorphology, hydrology, and bedrock and the legacy of old-growth logging done in the late 19th century (Napolitano, these proceedings). We also need to understand the mechanisms for channel change that are affected by altered inputs of water, sediment, and woody debris that originate from hillslopes, headwater channels, and riparian areas that were disturbed by recent logging. Finally, we need to understand stream conditions that are critical to aquatic fauna (e.g., salmonids and herpetofauna) and other water-resource issues in order to evaluate the importance of channel responses.

North Fork Caspar Creek: Modern Channel Conditions *The Main Channel*

North Fork Caspar Creek is a steep, perennial, gravel-bed channel typical of low-order streams draining second-growth, coastal

redwood forests of central and northern California (table 1). Its valley flat, which is 6 to 20 m wide, is confined between steep (≥ 70 percent), inner-gorge hillslopes where evidence of landslide activity is common (Cafferata and Spittler, these proceedings). Most of the valley flat is occupied by forested, gravelly terraces that stand a meter or more above the channel bed and are rarely, if ever, flooded (Napolitano 1996). Their origin will be discussed later.

The bed of the main channel (Stations LAN to ARF; Preface, fig. 2, these proceedings) commonly consists of a thin (<0.5 m) layer of cobbles, gravel, and finer material overlying bedrock, which is intermittently exposed (fig. 1). Much of this bed is composed of a framework of coarse colluvium or lag material (large, angular cobbles and boulders that remain as deposited by streamside landslides and debris flows). This material is too coarse to be moved

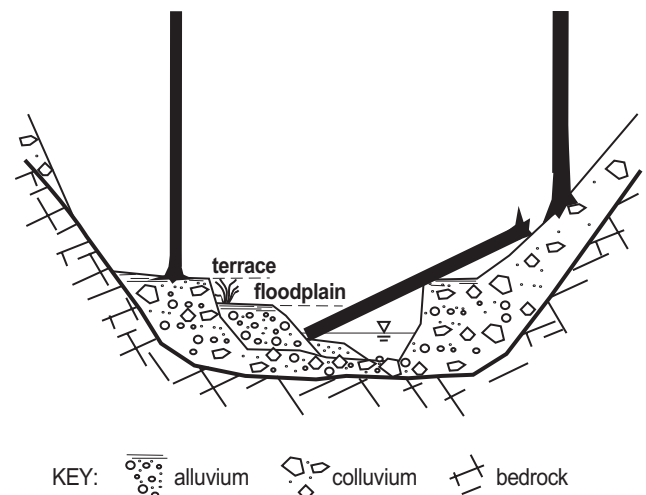

Figure 1—Idealized cross section of the mainstem channel of North Fork Caspar Creek. “Colluvium” is debris flow deposits.

Table 1—Dimensions of North Fork Caspar Creek near Station ARF.

Drainage area	380 ha
Order	3 ^a
Channel gradient	0.02
Mean annual discharge	0.092 m ³ s ⁻¹
Bankfull discharge	5.4 m ³ s ⁻¹
Mean bankfull width	7.7 m (2-12 m)
Mean bankfull depth	0.6 m

^aDetermined from 1:24,000 topographic map and including non-blue-line channels.

¹ An abbreviated version of this paper was presented at the Conference on Coastal Watersheds: The Caspar Creek Story, May 6, 1998, Ukiah, California

² Research Hydrologist, Pacific Southwest Research Station, USDA Forest Service, 1700 Bayview Dr., Arcata CA 95521

³ Environmental Scientist, Bay Area Water Quality Control Board, 2101 Webster St., Oakland, CA 94612

by even the largest floods; it helps stabilize the bed but also inhibits scour of deep pools and makes much of the channel unsuitable for spawning. Bars of alluvium (rounded gravel and sand transported by streamflow) overlie the lag material near large landslides and tributary junctions, upstream and downstream of woody debris jams, and in reaches widened by debris-induced bank erosion. The highest bars are capped with fine sediment (silt and fine sand) and herbaceous vegetation, and grade into active floodplains (surfaces which are flooded once every other year or so). Bars furnish the bulk of the bed load transported during peak flows. Fine bed load (sand and fine gravel) is stored in pools and transported during modest peak flows that are too weak to mobilize channel armor (single layers of gravel and cobbles capping more mobile bed material).

Sediment Sources

Sediment in Caspar Creek is derived from the Coastal Belt Franciscan Assemblage (Kramer 1976) which in this basin consists mostly of moderately fractured and weathered, interbedded, greywacke sandstone and shale. This material is highly erodible. Deep weathering has produced fine-grained soils and soft colluvium that readily decompose to fine material (silt and fine sand) during erosion and transport.

Streamside landslides that border much of the valley flat of the mainstem channel are large but infrequent sources of sediment. In 1974, for example, a landslide (3,300 m³) entered the North Fork channel, and another entered the South Fork (600 m³); their volume equaled 56 percent and 42 percent, respectively, of the total sediment yield for that year, although not all of the landslide material reached the downstream measurement stations (Rice and others 1979). These types of shallow landslides from the inner gorge are merely the surficial erosion of the toes of much more extensive and deeper, rotational failures (Cafferata and Spittler, these proceedings). Disturbance of inner gorges by logging or road building could increase surficial landsliding, but it is unlikely that the larger-scale failures would be affected.

Another source of sediment is gullies and debris flows that erode colluvium filling low-order valleys and unchannelized swales. We have not witnessed a significant debris flow since establishment of the experimental watershed, but much of the valley fills and deltas at the mouths of small tributaries were apparently deposited by debris flows (Napolitano 1996). More chronic sediment sources are enlargement and collapse of soil pipes leading to gully erosion of low-order valley fills (Keppeler and Brown, these proceedings). Logging of old-growth forests and loss of large chunks of woody debris that would buttress these deposits in swales may have accelerated this process. Increased and diverted runoff from roads during intense rainstorms could promote gullying and debris flows, but since the roads in NFCC basin are located near ridges, this has not been an important process.

Bank erosion and net scour of the active channel of the mainstem is a minor source of sediment overall, but a major source of gravel. From 1980 to 1988, channel scour accounted for only 13 percent of the yield of total sediment, but 42 percent of the gravel (Napolitano 1996). Most gravel (>90 percent) came from sediment

stored in the active channel rather than from bank erosion.

The bulk of the sediment in NFCC (70 percent) is transported in suspension as silt and fine sand; the remainder is transported as bed load of sand and gravel. This means that most of the sediment reaching the mainstem has little effect on channel processes but instead is carried out of the basin with the flow. A small amount of suspended sediment is deposited on floodplains and helps to build streambanks.

Large Woody Debris

Large woody debris (LWD) exerts an important influence on channel morphology, sediment transport, and aquatic habitats in NFCC. LWD enters the channel mostly through windthrow and bank erosion at an average rate of 12 m³ha⁻¹yr⁻¹, which is roughly equivalent to two logs 4 m long and 0.3 m in diameter entering a 100-m long reach each year (O'Connor and Ziemer 1989; Surfleet and Ziemer 1996; Elizabeth Keppeler, unpublished report, 1996). Approximately 340 m³ha⁻¹ of LWD was stored in or over the channel in 1987. This value is at the low end of the range for channels in old-growth redwood forests in Redwood National Park [average, 1,590 m³ha⁻¹; range, 240-4,500 m³ha⁻¹ (Keller and others 1995)].

Sediment transport and storage is strongly affected by LWD. The formation of debris jams commonly causes bank erosion, but also induces sediment deposition upstream and downstream. As a result, there is no net effect on sediment yield downstream from additions of LWD (Napolitano 1996). Nevertheless, the release and capture of bed material by LWD probably induces strong temporal and spatial variation in bed load transport (Lisle 1989, Mosley 1981). We suspect that the variable storage capacity created by LWD may buffer inputs of bed material, making it difficult to detect short-term trends in sediment yield from the watershed.

Large woody debris is responsible for much of the channel complexity in NFCC. For example, 55 percent of the pools in a 370-m study reach just upstream of the NFCC weir were associated with LWD from 1991 to 1997. LWD provides cover for aquatic fauna and a food base for the aquatic ecosystem. Debris jams commonly lead to channel widening, bar deposition, and formation of multiple channels. In the course of the formation and breakup of a large jam, an active floodplain can be created within the widened area well below the elevation of the laterally eroded terrace. A floodplain can be expected to be more closely linked than higher surfaces to the aquatic ecosystem by storing and exchanging fine sediment, organic matter, and nutrients more frequently, and by offering new riparian habitats.

Response of the Channel to Recent Logging

The most profound effects of logging on NFCC persist from the legacy of 19th century logging (Napolitano, these proceedings). These include a relatively simple channel isolated by incision from its former floodplain (the present 1- to 2-m terrace) and the low volume and small size of LWD. Recent experimental logging has caused greater summer discharge (Keppeler, these proceedings), substantial inputs of LWD from blowdowns (Reid and Hilton, these

proceedings), and modest increases in runoff during low-magnitude stormflows (Ziemer, these proceedings) and suspended sediment transport (Lewis, these proceedings). In this section, we attempt to relate these effects to changes in the mainstem channel, and discuss their effect on the aquatic ecosystem.

Bed Load Transport

First, we examine possible changes in the yield of bed load (ranging in particle size from fine sand to gravel) from the NFCC basin. Bed load yield since 1963 is evaluated by annual measurements of the volume of sediment filling the reservoirs behind the weirs in NFCC and South Fork of Caspar Creek (SFCC), although approximately 40 percent of the material trapped by the weirs is suspended sediment (Lewis, these proceedings). Annual yields in NFCC have varied from 0 (for seven of the 35 years) to 2,500 Mg (in 1974).

The magnitude and frequency of flows capable of transporting sediment and scouring or filling the channel each year must be accounted for in order to explore responses due to logging. To do this, we quantified the relative effectiveness of annual runoff to transport bed material. First, we computed an empirical relation between instantaneous bed load transport rate at Station ARF and discharge (data furnished by Jack Lewis). Then we applied this relation to values of mean daily discharge at the weir to estimate daily bed load yield and summed these values over each year to predict annual bed load yield for the entire period of record. This method underestimates the annual yield measured by reservoir surveys for a variety of reasons. However, we do not intend to predict reservoir filling by this method. Instead, we wish to weight daily discharges according to their sediment-transport capacity and thereby evaluate a “total annual effective discharge” (Q_e) in order to see if logging increased bed load transport independently of variations in runoff.

This response could appear as a departure from the relation between annual bed load yield (G_B) and Q_e (fig. 2) or a change in relative yields of NFCC and SFCC (not shown). No such response was evident. For corresponding ranges of Q_e , values of G_B for water years (WY) of the postlogging period (1990-1996) plot among the values of the prelogging period, and there was no apparent change in relative yields of NFCC and SFCC. A positive correlation between G_B and Q_e ($r^2 = 0.58$) indicates that bed load yield is dependent on storm runoff, thus the modest increase in storm runoff (Ziemer, these proceedings) may have increased bed load transport, but this was not borne out in bed load yields measured in the NFCC reservoir.

Large Woody Debris

In 1995, extensive tree blowdowns that were exacerbated in buffer strips along NFCC substantially increased LWD volumes in the channel and valley floor (Reid and Hilton, these proceedings). The volume of LWD in debris jams and pools increased significantly in NFCC compared to SFCC from 1994 to 1996, and a much greater volume lay suspended over the channel (Elizabeth Keppeler, unpublished report, 1996). According to Keppeler, “Straight open reaches are becoming stair-stepped with woody debris accumulations and stored sediment. In the last year alone (1996),

the number of sediment storage features associated with woody debris has nearly doubled (unpublished step data). On the SFCC, no evidence of a similar trend is observed.”

Scour and Fill of the Channel

Channel changes in 2.4 km of the mainstem have been monitored since 1980 by annual (or less frequent) surveys of 60 channel cross sections spaced at an average of 40 m between Station ARF and the old splash dam (Preface, fig. 2, these proceedings). Net scour and fill measures the accumulation or depletion of sediment in the channel; it is the net change in cross-sectional area of the channel (i.e., fill minus scour). Total scour and fill measures channel variability; it is the cross-sectional area undergoing change (i.e., scour plus fill).

Mean annual total scour and fill for the whole channel correlated strongly with Q_e (fig. 2; $r^2 = 0.90$). This suggests that any increase in bed load yield from augmented magnitudes of low-to-moderate peak flows after logging (Ziemer, these proceedings) could come from the bed and banks of the main channel.

We examined spatial patterns of erosion and deposition in the main channel by calculating values of net and mean annual total scour and fill at each cross section for a prelogging period (1986-1990) and a postlogging period (1991-1997). Both measures of scour and fill varied widely during both periods but were greater during the postlogging period (fig. 3). The entire channel filled an average of 0.08 m² during the prelogging period and 0.24 m² during the postlogging period. This is equivalent to about 1,040 Mg of bed material filling the channel during the postlogging period, or about 60 percent of the bed load yield for that period. Therefore, a substantial portion of bed load has accumulated in the channel.

Mean annual total scour and fill generally increased downstream and was commonly high near tributary junctions, although no difference was apparent between logged and unlogged tributaries. Net fill was highest in the downstream 700 m of channel, which is adjacent to a clearcut buffer strip along the left bank. Most

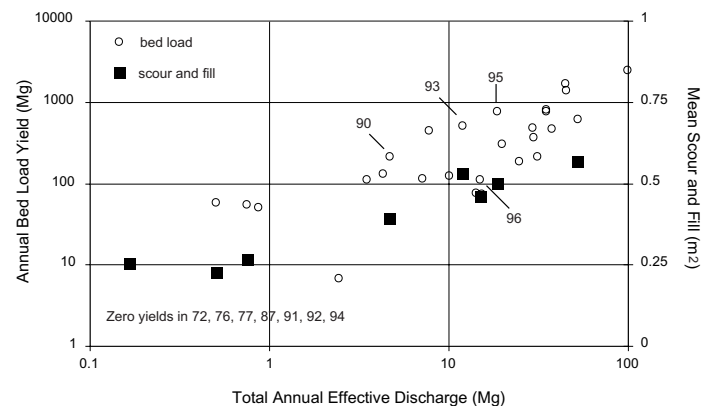

Figure 2—Annual bed load yield measured in the North Fork reservoir and mean annual total scour and fill versus total annual effective discharge. Data points are identified by year for the postlogging period.

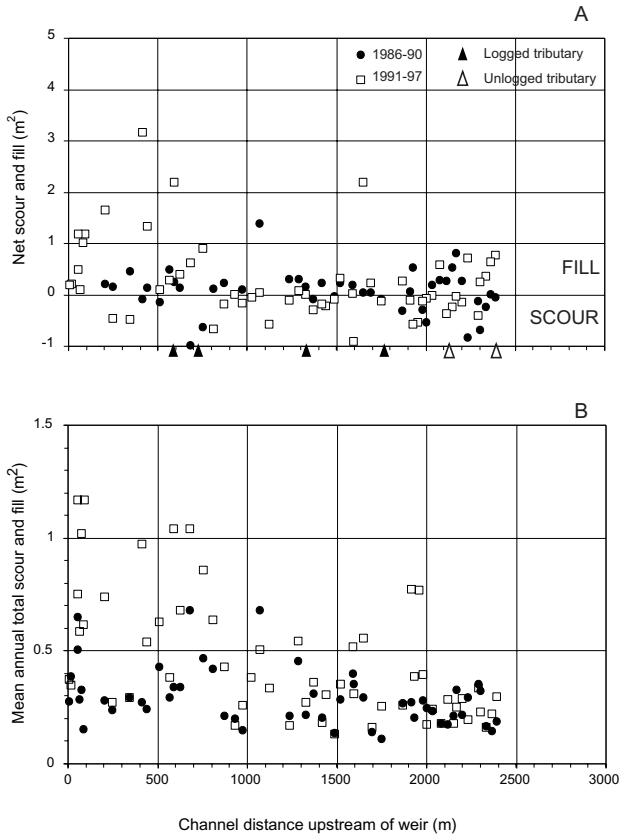

Figure 3—Net and average annual scour and fill versus channel distance upstream of the North Fork weir for the prelogging (1986-1990) and postlogging (1990-1997) periods. Values are determined from repeated surveys of channel cross sections. Values of net scour and fill are missing for channel distances of 0 to 200 m (1986-1990) because of missing measurements at the beginning of the period.

of the filling during the postlogging period occurred here in WY1996, shortly after windstorms blew down trees in buffer strips (Reid and Hilton, these proceedings). This association of high net fill in time and place with LWD inputs substantiates Keppeler’s account of channel changes associated with new LWD. We have monitored pool dimensions in part of this reach since 1991.

Pools

We measured residual volume and fine-sediment volume (Hilton and Lisle 1993) in all pools upstream of the main weirs in NFCC (a 340-m long reach) and SFCC (a 470-m long reach) annually during the postlogging period (1991 to 1997). Scoured pool volume (SPV) is residual pool volume plus fine sediment volume; it measures the basin scoured in bed material without the more transient fine sediment that is deposited during waning flows of flood hydrographs. Total SPV nearly tripled in NFCC and varied non-systematically in SFCC during the period (*fig. 4*). In NFCC, the

fraction of residual pool volume filled with fine sediment (V^* ; Lisle and Hilton 1992) increased from 1991 to 1994 and then decreased below the initial value by 1997. In SFCC, V^* decreased in the same period, except for a slight rise in 1997.

Discussion and Conclusions

Logging increased low and moderate streamflows and greatly increased the input of LWD from blowdowns in buffer strips bordering the mainstem channel. Apparent channel responses, particularly in a downstream reach affected by blowdowns, have been an increase in storage of bed material, an increase in the number and total volume of pools, and a temporary increase in fine sediment stored in the channel. What is the most likely explanation of these responses?

An increase in peak flows would supply more energy to scour pools, but if accompanied by increased erosion, could cause net sedimentation of pools. This may have been expressed by a greater accumulation of fine sediment as pools enlarged in NFCC (increased V^* and SPV). However, a net accumulation of sediment in the same reach where pools enlarged runs counter to an argument that increased runoff alone has scoured sediment from pools. Moreover, we believe that increases in storm runoff were too modest to significantly affect sediment transport or pool volume.

Simultaneous channel fill and the enlargement and proliferation of pools without a change in bed load yield can be explained by the effects of increased LWD. Increased LWD volumes tend to increase the number and volume of pools by creating more stepped and converging flow patterns (Keller and Swanson 1979). Newly formed debris jams can also trap bed load and promote scour downstream by

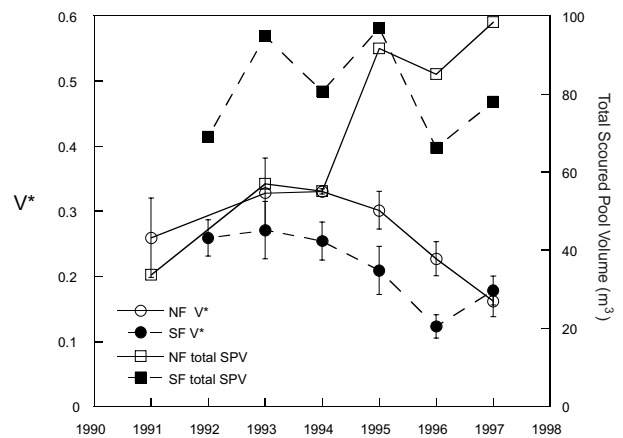

Figure 4—Temporal variations in fraction of residual pool volume filled with fine sediment (V^*) and total scoured pool volume (SPV) in downstream reaches of North Fork (NF) and South Fork (SF) Caspar Creek. Brackets around V^* values denote ± 1 s.e. WY1992 was exceptionally dry, so we assume there was no change between existing or missing values for WY1991 and WY1992.

locally and temporarily starving the channel of sediment. LWD also increases sediment storage by trapping sediment behind debris jams and by extracting flow energy elsewhere that would otherwise be exerted on the channel bed. New LWD also increases bank erosion, but the net result for sediment transport in NFCC was neutral before recent logging (Napolitano 1996), and no changes were detected in bed load yield in NFCC after logging.

Our interpretation is consistent with results from an experiment on similar channels in southeastern Alaska, where LWD was removed from logged channels that had accumulated large volumes from logging slash (Lisle 1989), and from an experiment on channels in the blast zone near Mt. St. Helens, Washington, where large volumes of sediment and LWD were introduced by the eruption and LWD was experimentally removed (Lisle 1995). In both cases, which represent a reversal of the effects observed in NFCC, removal of LWD caused a loss of both pool volume and stored sediment. In summary, increased LWD is commonly associated with increased sediment storage and pool volume in a variety of gravel bed streams.

Recent changes in NFCC favor aquatic vertebrates. Increases in populations of older juvenile steelhead trout and salamanders (Nakamoto, these proceedings) may have resulted from increased LWD (as cover), pool volume, and habitat complexity. Moreover, coho salmon, which have a tenuous presence in NFCC and SFCC because of the small size of these streams, are especially favored by large volumes of LWD and pool habitat (Nickelson and others 1992). Productivity is probably also augmented by greater summer flows.

However, an interpretation that logging and, in particular, consequent increases in LWD from blowdown are favorable for the aquatic ecosystem may be a misconception created by the short time over which we have observed effects. To look beyond the immediate results, we must consider the long-term supply of LWD, which was severely depleted by 19th-century logging, further depleted by recent logging of second-growth trees that could have entered the channel, and cashed in by recent blowdown of some trees in the streamside buffer zone. The prognosis for future decades is a greater departure from natural volumes of LWD in the channel as existing LWD decays and inputs decrease from depleted riparian sources. We predict that reaches bordered by clearcuts and buffer strips will lose sediment storage, pool volume, and habitat complexity as inputs of LWD decline.

Acknowledgments

Sue Hilton is mostly responsible for analyzing channel surveys and measuring and analyzing pool volumes. Maria Hansler, Lex Rohn, and Diane Sutherland helped to measure pool volumes. Channel cross sections were surveyed by Liz Keppeler and her coworkers in Fort Bragg.

References

- Hilton, S.; Lisle, T.E. 1993. **Measuring the fraction of pool volume filled with fine sediment.** Res. Note PSW-RN-414. Berkeley, CA: Pacific Southwest Research Station, Forest Service, U.S. Department of Agriculture; 11 p.
- Keller, E.A.; MacDonald, A.; Tally, T.; Merritt, N.J. 1995. **Effects of large organic debris on channel morphology and sediment storage in selected tributaries of Redwood Creek, northwestern California.** In: Nolan, K.M.; Kelsey, H.M.; Marron, D.C., eds. Geomorphic processes and aquatic habitat in the Redwood Creek basin, northwestern California, U.S. Geol. Surv. Prof. Pap. 1454. P1-P29.
- Keller, E.A.; Swanson, F.J. 1979. **Effects of large organic material on channel form and fluvial process.** Earth Surface Processes 4: 361-380.
- Keppeler, E.T. 1996. **Caspar Creek large organic debris revisited.** Unpublished draft supplied by author.
- Kramer, J.C. 1976. **The geology and tectonic implications of the Coastal Belt Franciscan, Fort Bragg-Willits Area, Northern California Coast Ranges, California.** Davis: University of California; PhD. Dissertation.
- Lisle, T.E. 1989. **Effects of woody debris on anadromous salmonid habitat, Prince of Wales Island, southeast Alaska.** North American Journal of Fisheries Management 6: 538-550.
- Lisle, T.E. 1995. **Effects of coarse woody debris and its removal on a channel affected by the 1980 eruption of Mount St. Helens, Washington.** Water Resources Research 31(7): 1797-1808.
- Lisle, T.E.; Hilton, S. 1992. **The volume of fine sediment in pools: an index of sediment supply in gravel-bed streams.** Water Resources Bulletin 28(2): 371-383.
- Mosley, M.P. 1981. **The influence of organic debris on channel morphology and bed load transport in a New Zealand forest stream.** Earth Surface Processes and Landforms 6: 571-579.
- Napolitano, M.B. 1996. **Sediment transport and storage in North Fork Caspar Creek, Mendocino County, California: water years 1980-1988.** Arcata, CA: Humboldt State University; 148 p. M.S. thesis.
- Nickelson, T.E.; Rodgers, J.D.; Johnson, S.L.; Solazzi, M.F. 1992. **Seasonal changes in habitat use by juvenile coho salmon (*Oncorhynchus kisutch*) in Oregon coastal streams.** Canadian Journal of Fisheries and Aquatic Science 49: 783-789.
- O'Connor, M.D.; Ziemer, R.R. 1989. **Coarse woody debris ecology in a second-growth *Sequoia sempervirens* forest stream.** Gen. Tech. Rep. PSW-110. Berkeley, CA: Pacific Southwest Research Station, Forest Service, U.S. Department of Agriculture; 165-171.
- Rice, R.M.; Tilley, F.B.; Datzman, P.A. 1979. **A watershed's response to logging and roads: South Fork Caspar Creek, California, 1967-1976.** Res. Paper PSW-146. Berkeley, CA: Pacific Southwest Research Station, Forest Service, U.S. Department of Agriculture; 12 p.
- Surfleet, C. G.; Ziemer, R. R. 1996. **Effects of forest harvesting on large organic debris in coastal streams.** In: LeBlanc, John, ed. Conference on coast redwood forest ecology and management; 1996 June 18-20; Humboldt State Univ., Arcata, CA. 134-136.

Effects of Timber Harvest on Aquatic Vertebrates and Habitat in the North Fork Caspar Creek¹

Rodney J. Nakamoto²

Abstract: I examined the relationships between timber harvest, creek habitat, and vertebrate populations in the North and South forks of Caspar Creek. Habitat inventories suggested pool availability increased after the onset of timber harvest activities. Increased large woody debris in the channel was associated with an increase in the frequency of blowdown in the riparian buffer zone. This increase in large woody debris volume increased the availability of pools.

No dramatic changes in the abundance of young-of-the-year steelhead, yearling steelhead, coho, or Pacific giant salamanders were directly related to logging. High interannual variation in the abundance of aquatic vertebrates made it difficult to contrast changes in abundance between pre-logging and post-logging periods. Changes in channel morphology associated with increased volume of large woody debris in the channel suggest that yearling steelhead, coho, and Pacific giant salamanders may benefit from logging in the short-term because of increased living space. However, over a longer time scale these conditions will probably not persist (Lisle and Napolitano, these proceedings).

The impacts of timber harvest on aquatic ecosystems can range from detrimental to beneficial depending on the geology and geomorphology of the watershed, the method of timber harvest, and the presence of other activities in the watershed. Disturbance of hillslope and riparian soils can result in increased sediment delivery to streams. This increased sediment input may result in decreased depth and availability of pools (McIntosh and others 1993), decreased survival of incubating salmonid eggs (Reiser and White 1988), and/or increased turbidity (Burns 1972). Alterations in the routing of surface and subsurface runoff may result in increased peak storm flows (Wright and others 1990). Increased peak flows may scour redds or bury them under sediments (Lisle 1989). Removal of timber from riparian areas decreases the amount of large woody debris available for recruitment into the channel. Within the Pacific Northwest, large woody debris plays a critical role in pool formation, sediment storage, and cover availability (Beechie and Sibley 1997, Bilby and Ward 1991). In contrast, thinning of the riparian canopy allows greater amounts of solar radiation to reach the stream. Increased incident solar radiation has been linked to increased aquatic productivity (Bisson and Sedell 1984, Burns 1972, Holtby 1988, Murphy and Hall 1981, Newbold and others 1980, Thedinga 1989).

During the late 1960's, the abundance of salmonids declined in South Fork Caspar Creek after logging (Burns 1972). This decline was associated with disruption of the streambed by heavy

equipment, increased sediment input associated with slope and bank failures, road construction just upslope of the channel, and excessive amounts of slash left in the channel. However, after only 2 years salmonid abundance had returned to near pre-logging levels. Burns (1972) concluded that logging activities were compatible with anadromous fish production as long as adequate attention was given to stream and watershed protection. Unlike the logging which occurred in the South Fork, within the North Fork logging roads were constructed along ridge tops, about 81 percent of the logs were removed by cable yarding, heavy equipment was not operated in the channel, and a riparian buffer strip was maintained to protect the stream. Given this new set of conditions, the goal of this study was to document the effects of logging in the North Fork on the abundance of aquatic vertebrates and their habitat.

Study Site

The North and South forks of Caspar Creek lie approximately 11 km southeast of Fort Bragg, California, on the Jackson State Demonstration Forest. Before this study, the South Fork had been logged twice and the North Fork had been logged once. During the late 1800's the watersheds were clearcut and burned. After logging, the areas were primarily reforested by redwood (*Sequoia sempervirens*) and Douglas-fir (*Pseudotsuga menziesii*). Beginning in 1971, the South Fork was divided into three selective-cut logging sales. A network of skid trails was constructed to transport fallen trees by tractor. By the end of the 3-year operation, 15 percent of the watershed was in roads, landings, and skid trails, and 67 percent of the timber volume in the South Fork was removed (Keppeler and Ziemer 1990). Logging activities in the North Fork began in May 1989. The watershed was divided into eight separate clearcut logging units. High-lead (cable) logging was used to remove timber from approximately 44 percent of the watershed area. Thirty- to 60-m-wide riparian buffer zones were maintained along the entire length of the mainstem channel. Logging was completed in January 1992.

The study reaches in both creeks began upstream of impoundments created by V-notch weirs. Drainage areas in the study reaches were 473 ha and 424 ha in the North Fork and South Fork, respectively. Slopes in both watersheds are relatively gentle with about 35 percent of the two watersheds having slopes of <30 percent. Both watersheds contain well-drained soils derived from sandstone. The climate is typical of coastal northern California. Winters are mild and wet. Average annual precipitation is about 1,190 mm. Approximately 90 percent of the annual precipitation falls from October through April. Average discharges in the watersheds are similar, varying from less than 0.01 m³s⁻¹ during the summer to 0.71 m³s⁻¹ during the winter. Daily summer water temperatures in both creeks vary between 10 °C and 20 °C and

¹ An abbreviated version of this paper was presented at the Conference on Coastal Watersheds: The Caspar Creek Story, May 6, 1998, Ukiah, California.

² Fishery biologist, U.S. Forest Service, Redwood Sciences Laboratory, 1700 Bayview Drive, Arcata, CA 95521.

average about 13 °C. Winter water temperatures in the creeks vary between 1 °C and 12 °C, averaging approximately 7 °C. Riparian vegetation in the South Fork is composed primarily of red alder (*Alnus rubra*) and tan oak (*Lithocarpus densiflorus*). Riparian vegetation in the North Fork is composed primarily of Douglas-fir, redwood, and grand fir (*Abies grandis*).

Steelhead (*Oncorhynchus mykiss*) and coho salmon (*Oncorhynchus kisutch*) spawn in both creeks. Stickleback (*Gasterosteus aculeatus*) occur only in the South Fork. Amphibians inhabiting the North Fork include Pacific giant salamander (*Dicamptodon tenebrosus*), tailed frog (*Ascaphus truei*), and rough-skinned newt (*Taricha granulosa*). Pacific giant salamander and rough-skinned newt are present in the South Fork; however, tailed frogs are absent.

Methods

I categorized habitat units in the North and South forks during the summers of 1986, 1990, 1993, and 1995 according to the classification system described by McCain and others (1990). Habitat inventories were conducted in those years when I perceived changes in habitat availability and distribution associated with high discharge events. The habitat inventories in both creeks began at the upstream ends of the weir ponds and extended to the upstream barrier to fish passage in the North Fork (approximately 2,700 m) and until the stream became intermittent in the South Fork (approximately 3,000 m). Once each habitat unit was identified, I recorded a minimum of three equally spaced width measurements and three equally spaced length measurements for each habitat unit. I measured habitat depth at three equally spaced locations along each of the width transects and maximum habitat depth.

On the basis of the results of the inventory, I randomly selected individual habitat units for sampling of aquatic vertebrates. The units were selected to represent the array of habitat types available in each creek. Selected habitat units were flagged to facilitate relocation during later surveys. New habitat units were randomly selected after successive inventories.

Except for the 1986 survey that took place in August, I surveyed aquatic vertebrates in June and July. Block nets were placed across the upstream and downstream boundaries of the habitat unit. Fish were sampled to depletion using multiple passes with a backpack electrofisher. Salamanders were not sampled to depletion, but few were captured in the final electrofishing pass. Captured vertebrates were anesthetized using tricaine methanesulfonate (trade name MS-222)³ and identified to species. I recorded fork length (mm) and total length (mm) for each of the fishes and body length from the tip of the snout to the anal vent for salamanders. I recorded maximum body length for all other amphibians. In addition, between 1990 and 1995 I recorded weights for fishes and amphibians using a portable electronic balance (Ohaus CT-200, readability 0.01 g). All fish and amphibians were then

returned to the habitat unit from which they were collected. I recorded the dimensions of the unit sampled (i.e., length, width, depth, etc.) using the same protocol as during habitat typing.

I used automated temperature-monitoring equipment to monitor air and water temperatures in the creeks between April 1989 to August 1994. The data recorders were positioned at sites just upstream of the weir ponds. The data recorders were programmed to record temperature at 1-hour intervals.

Data on habitat and vertebrates were summarized by sampling year and grouped into one of two survey periods: pre-logging (1986-1989) or logging (1990-1995) depending on the year in which the survey occurred. Road building and timber falling began in the North Fork in May 1989. Because my sampling took place only one month after the onset of logging, I assumed that there would be no detectable impact during that year. Timber harvest was completed in January 1992. I collected habitat availability data once during the pre-logging period and three times during the logging period. I divided habitat units into either fast (riffle, run, cascade, etc.) or slow (pool) types and calculated the availability of each type on the basis of area. I further determined the proportion of pool habitats in each creek associated with large woody debris (logs, rootwads). Vertebrates were divided into one of four groups: young-of-the-year (YOY), steelhead (≤ 70 mm fl), yearling steelhead (> 70 mm fl); coho; or larval Pacific giant salamanders. I calculated the difference in mean density within each year, between the two creeks and compared the differences before and after logging (Stewart-Oaten and others 1986). I conducted separate analyses for each of the vertebrate groups using Mann-Whitney-Wilcoxon tests to compare pre- and post-logging differences. I used the same method to analyze mean body length. Since the vertebrate biomass and temperature data were collected only during the logging period, the data were not subjected to statistical analysis.

Results

Habitat

The availability of fast and slow water habitat was similar between creeks during the 1986 habitat inventory (*table 1*). Slow water habitat comprised approximately 25 percent of the available

Table 1—Proportional habitat availability in the North Fork and South Fork Caspar Creek. Fast habitat types include riffles, cascades, runs, and glides. Slow habitat types include all pools. Habitat inventories were conducted during May or June of each assessment year. Pools with large woody debris (LWD) include the proportion of total pool availability that incorporated large woody debris as a critical element in their formation on the basis of frequency of occurrence.

Year	North Fork Caspar			South Fork Caspar		
	Slow	Fast	Pools with LWD	Slow	Fast	Pools with LWD
1986	0.27	0.73	0.70	0.29	0.71	0.46
1990	0.41	0.59	0.51	0.52	0.48	0.43
1993	0.40	0.60	0.55	0.45	0.55	0.41
1995	0.44	0.56	0.53	0.35	0.65	0.42

³ The use of trade or firm names in this publication is for reader information and does not imply endorsement by the U.S. Department of Agriculture of any product or service.

habitat. However, after the 1990 habitat inventory the percentage of slow water habitat had increased to 41 percent in the North Fork and 52 percent in the South Fork. The 1993 and 1995 habitat inventories suggested that the habitat availability remained relatively stable in the North Fork whereas habitat availability in the South Fork tended to return to the 1986 level.

Large woody debris (LWD), including rootwads from standing trees, were critical in the formation of 70 percent of the pools in the North Fork during the 1986 habitat inventory (table 1). In contrast, only 55 percent of the pools in the South Fork incorporated LWD. Later inventories revealed that the percentage in the North Fork was reduced to between 45 percent and 57 percent. The proportion of pools associated with large woody debris in the South Fork ranged between 37 and 46 percent, between 1990 and 1995.

Mean monthly water temperatures in the North Fork were the lowest in December and the highest in July or August (fig. 1). Throughout the monitoring period mean monthly water temperatures ranged between 4.6 °C and 14.6 °C. Water temperatures averaged 0.4 °C higher in the North Fork compared to the South Fork. Air temperatures averaged 2.1 °C higher in the North Fork compared to the South Fork (fig. 2). The data suggested that air and water temperatures in the North Fork remained greater than temperatures in the South Fork throughout most of the monitoring period. The greatest differences for air and water temperatures between the North and South forks roughly coincided with the annual minimum and maximum monthly temperatures.

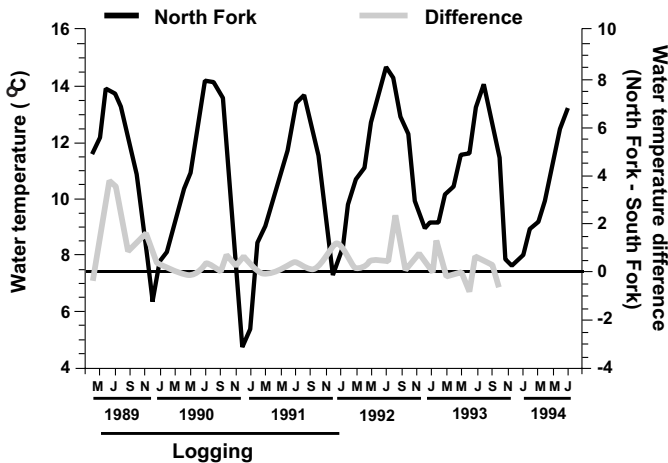

Figure 1—Mean monthly water temperature for the North Fork Caspar Creek and the difference in mean monthly water temperature between the North Fork and South Fork. The data were collected by automated temperature data loggers. The data loggers were programmed to record temperature at 1-hour intervals. The thermisters were accurate to within 0.2 °C.

Vertebrate Data

Young-of-the-Year Steelhead

Young-of-the-year (YOY) steelhead densities during the pre-logging period were slightly higher in the North Fork (0.93 YOY steelhead m⁻², n = 4, 0.12 S.E.) compared to the South Fork (0.78 YOY m⁻², n = 4, 0.09 S.E.) (fig. 3a). During the logging period, mean YOY steelhead densities in the North Fork (0.85 YOY m⁻², n = 6, 0.12 S.E.) were again greater than densities in the South Fork (0.59 YOY m⁻², n = 6, 0.04 S.E.), but lower than pre-logging densities. The differences in YOY steelhead density between creeks were not significantly different between survey periods (p = 0.38).

During the logging period YOY steelhead biomass in the North Fork averaged 0.97 g m⁻² (n = 6, 0.15 S.E.) whereas YOY steelhead biomass in the South Fork averaged 0.80 g m⁻² (n = 6, 0.07 S.E.) (fig. 3b). High interannual variation characterized the mean biomass in both creeks.

Young-of-the-year steelhead fork length averaged 40.6 mm (n = 4, 0.25 S.E.) for the pre-logging period and 45.2 mm (n = 6, 0.18 S.E.) for the post-logging period in the North Fork (fig. 3c). Mean fork length for steelhead from the South Fork averaged 42.5 mm (n = 4, 0.25 S.E.) for the pre-logging period and 45.8 mm (n = 6, 0.19 S.E.) for the post-logging period. The differences in mean fork length between creeks was not significantly different between survey periods (p = 0.46).

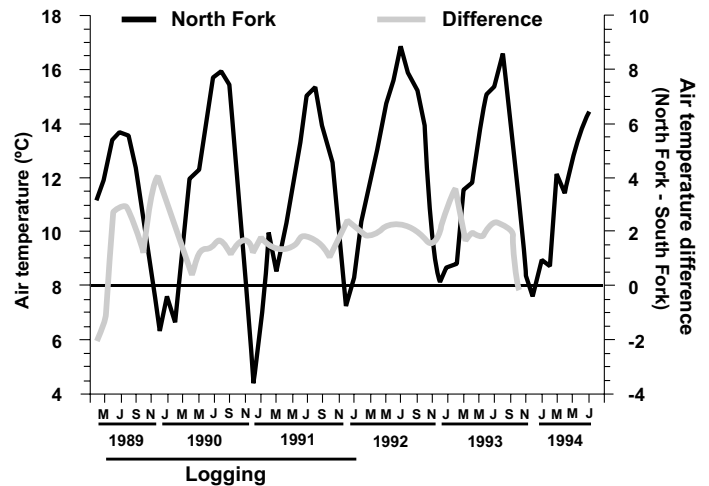

Figure 2—Mean monthly air temperature for the North Fork Caspar Creek and the difference in mean monthly air temperature between the North Fork and South Fork. The data were collected by automated temperature data loggers. The data loggers were programmed to record temperature at 1-hour intervals. The thermisters were accurate to within 0.2 °C.

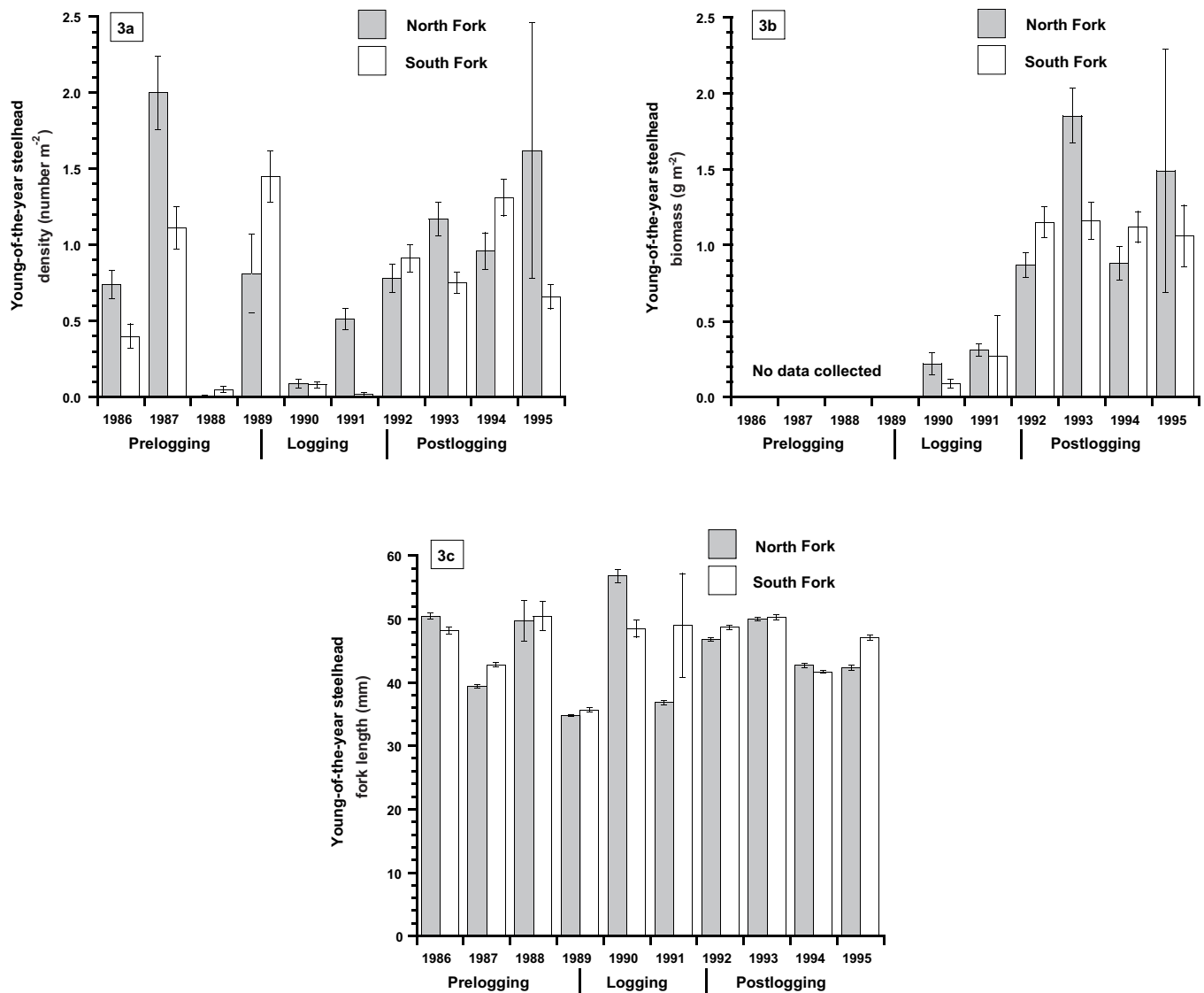

Figure 3—Mean and standard error for annual abundance (a), biomass (b), and fork length (c) for young-of-the-year steelhead in the North Fork and South Fork Caspar Creek, based on summer electrofishing surveys. Timber harvest activities began in May 1989 in the North Fork and were completed by January 1992.

Yearling Steelhead

Yearling steelhead densities during the pre-logging period in the North Fork and South Fork averaged 0.08 fish m⁻² (0.01 S.E.) and 0.05 fish m⁻² (0.01 S.E.), respectively (fig. 4a). During the logging period, steelhead densities averaged 0.12 fish m⁻² (0.02 S.E.) in the North Fork, slightly greater than for the pre-logging period. Steelhead densities in the South Fork were also slightly elevated at 0.07 fish m⁻² (0.01 S.E.). The difference in density between the creeks did not change significantly between pre-logging and logging periods (p = 0.54). Yearling steelhead biomass during the logging period averaged 1.31 g m⁻² (n = 6, 0.17 S.E.) in the North Fork and 0.97 g m⁻² (n = 6, 0.13 S.E.) in the South Fork (fig. 4b).

Mean fork length for yearling steelhead collected from the North Fork averaged 95.5 mm (2.36 S.E.) for the pre-logging period and 97.5 mm (1.37 S.E.) for the post-logging period (fig. 4c). Mean fork lengths for yearling steelhead collected from the South Fork were 104.0 mm (2.22 S.E.) and 97.0 mm (1.58 S.E.) for the pre-logging and post-logging periods, respectively. The differences in mean fork length between creeks were not significantly different between pre-logging and logging periods (p = 0.46).

Coho

Young-of-the-year coho densities were variable throughout the monitoring period (fig. 5a). Coho densities during the pre-logging

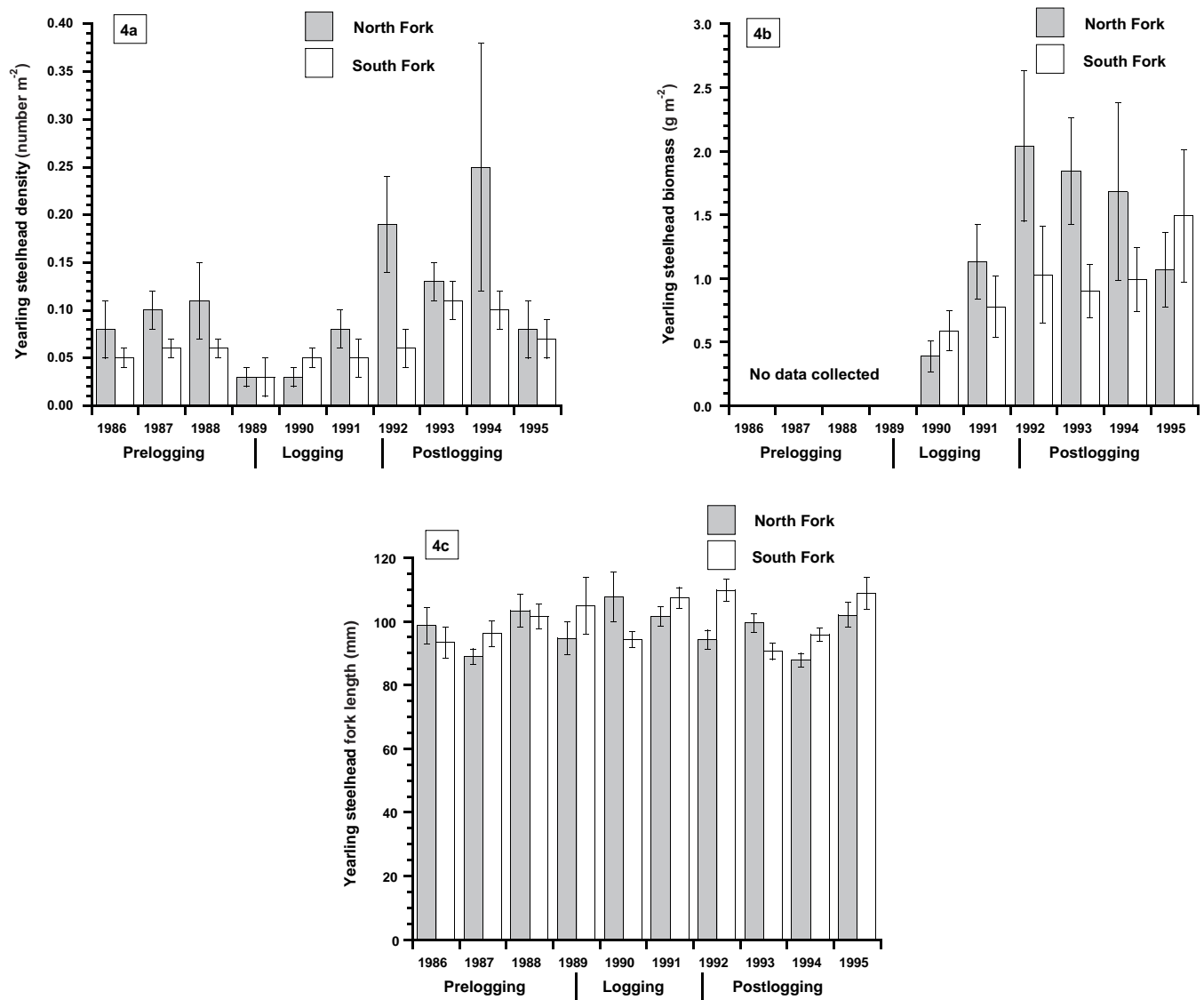

Figure 4—Mean and standard error for (a) annual abundance, (b) biomass, and (c) fork length for yearling steelhead in the North Fork and South Fork Caspar Creek, based on summer electrofishing surveys. Timber harvest activities began in May 1989 in the North Fork and were completed by January 1992.

period averaged 0.57 fish m⁻² (0.09 S.E.) in the North Fork and 0.65 fish m⁻² (0.08 S.E.) in the South Fork. Coho densities during the logging period declined significantly to 0.03 fish m⁻² (0.01 S.E.) in the North Fork and 0.07 fish m⁻² (0.01 S.E.) in the South Fork. The differences in coho density between creeks were not significantly different across survey periods (p = 0.18).

Coho biomass during the logging period declined to 0.07 g m⁻² (0.02 S.E.) and 0.21 g m⁻² (0.03 S.E.) in the North Fork and South Fork, respectively (fig. 5b). Throughout the logging period coho biomass remained extremely low in both creeks.

Coho from the North Fork averaged 55.7 mm fl (0.29 S.E.) and 59.8 mm fl (1.14 S.E.) for the pre-logging and logging periods,

respectively (fig. 5c). Coho from the South Fork averaged 54.8 mm fl (0.31 S.E.) during the pre-logging period and 61.9 mm fl (0.57 S.E.) during the logging period. The mean length of coho did not change significantly relative to the South Fork between pre-logging and logging periods (p=0.34).

Larval Pacific Giant Salamanders

Mean larval Pacific giant salamander (LPGS) densities throughout the monitoring period were higher in the North Fork compared to the South Fork (fig. 6a). Pre-logging densities in the North Fork averaged 1.33 LPGS m⁻² (0.18 S.E.) while densities in the South Fork averaged 0.93 LPGS m⁻² (0.09 S.E.) for the same period. Logging period

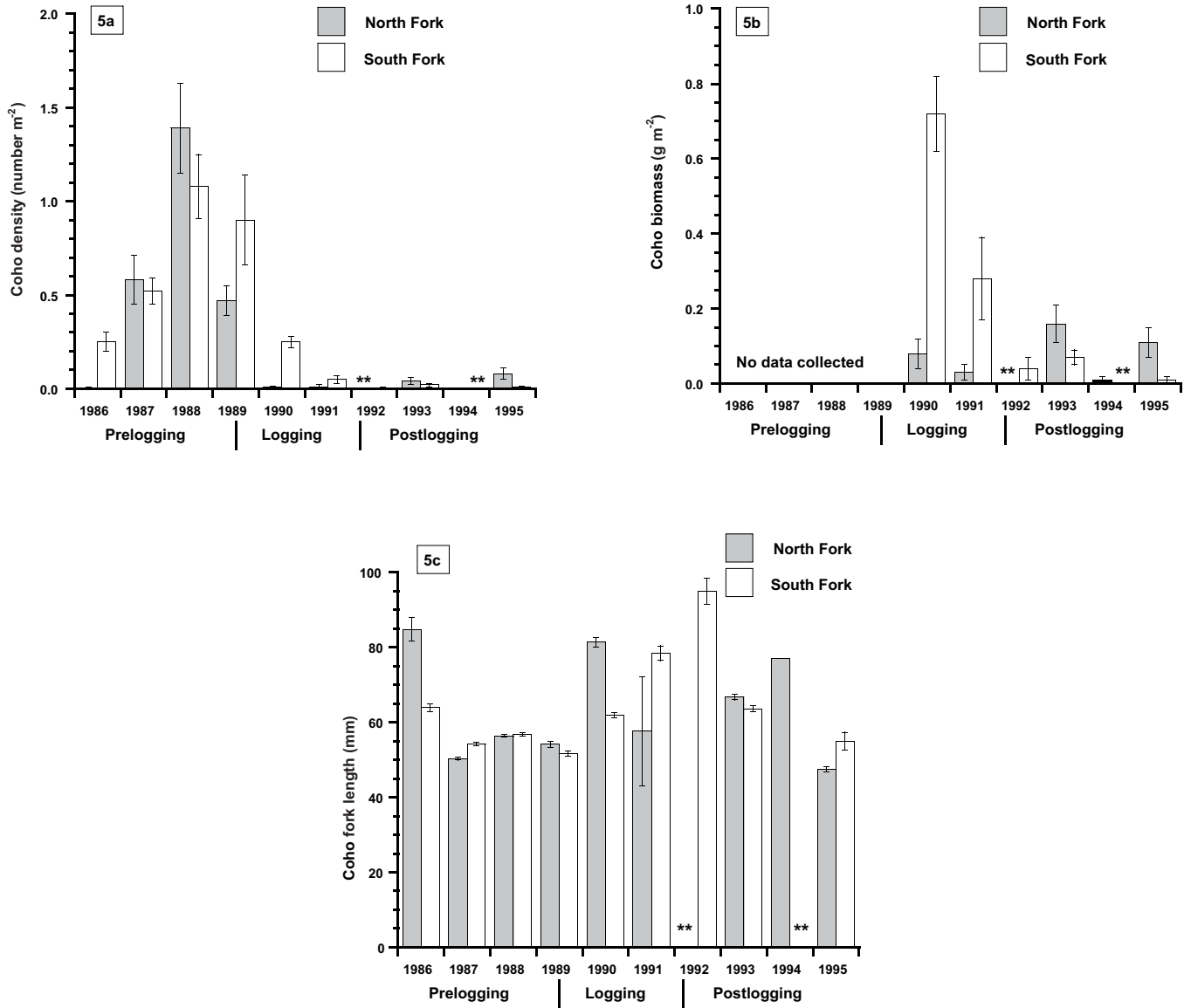

Figure 5—Mean and standard error for (a) annual abundance, (b) biomass, and (c) fork length for young-of-the-year coho in the North Fork and South Fork Caspar Creek, based on summer electrofishing surveys. Timber harvest activities began in May 1989 in the North Fork and were completed by January 1992. ** = no coho collected.

densities were slightly higher than pre-logging densities averaging 1.46 LPGS m⁻² (0.30 S.E.) in the North Fork and 1.28 LPGS m⁻² (0.07 S.E.) in the South Fork. No significant change in the mean density of North Fork LPGS was identified after logging (p=0.13).

Larval Pacific giant salamander biomass generally was 1.5 to 2.0 times greater than combined salmonid biomass for both creeks (fig. 6b). During 1995, LPGS biomass in the North Fork was estimated to be 10.4 g m⁻². Larval Pacific giant salamander biomass during the logging period averaged 5.39 g m⁻² (n = 6, 1.37 S.E.) in the North Fork and 4.39 g m⁻² (n = 6, 0.32 S.E.) in the South Fork.

Snout-to-vent length for LPGS collected during the pre-logging period averaged 36.6 mm (n = 3, 0.28 S.E.) in the North Fork and 39.6 mm (n = 3, 0.33 S.E.) in the South Fork (fig. 6c). Larval Pacific giant salamander collected during the logging period from the North Fork averaged 38.8 mm long (n = 6, 0.21 S.E.), while LPGS collected from the South Fork averaged 37.8 mm long (n = 6, 0.23 S.E.). The difference in snout-to-vent length between creeks was significantly larger during the logging period compared to the pre-logging period (p = 0.01).

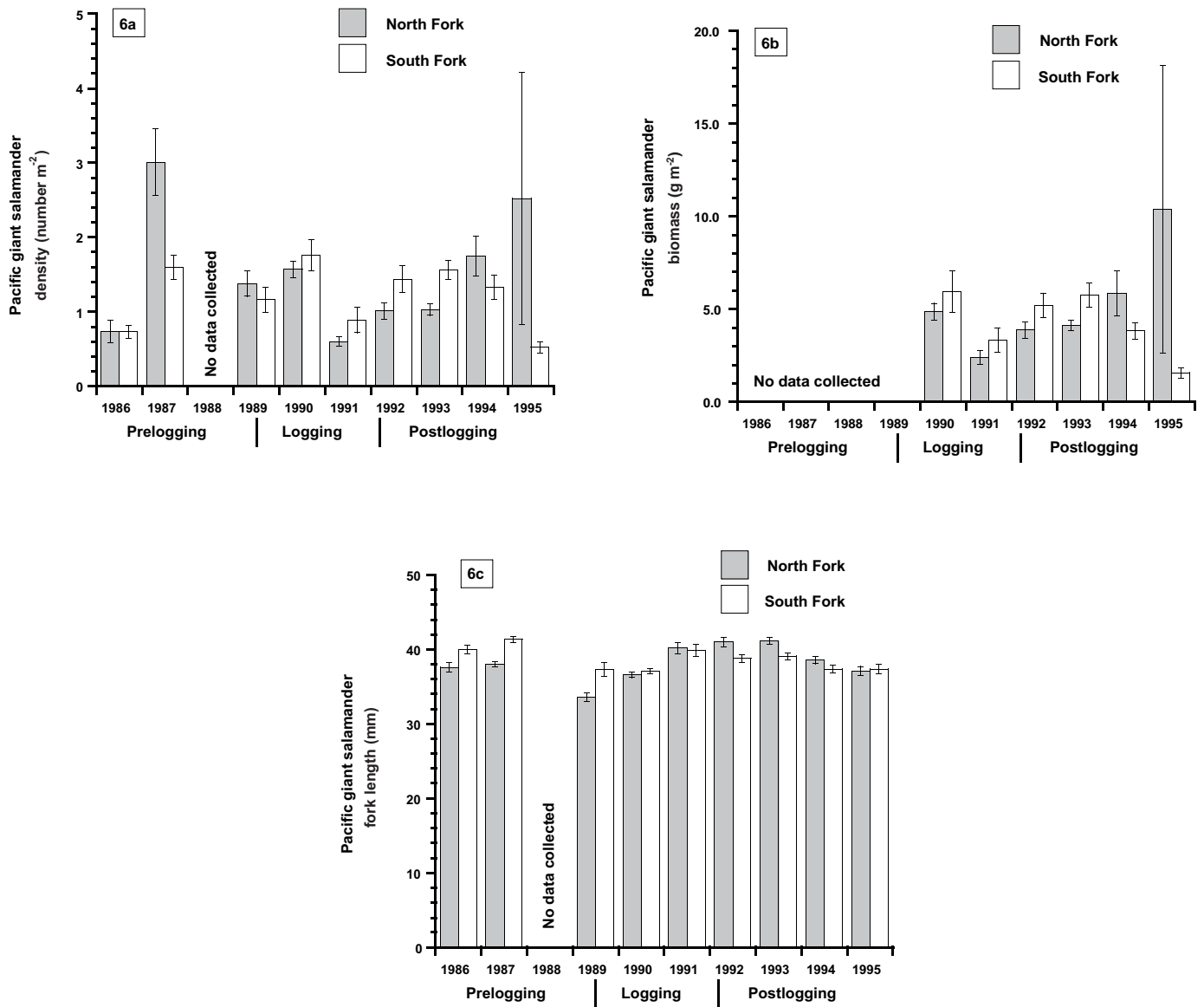

Figure 6—Mean and standard error for (a) annual abundance, (b) biomass, and (c) snout-to-vent length for larval Pacific giant salamanders in the North Fork and South Fork Caspar Creek, based on summer electrofishing surveys. Timber harvest activities began in May 1989 in the North Fork and were completed by January 1992.

Discussion

The effects of timber harvest in the late 1800's in the North Fork were still evident in 1987. Logging techniques used during that period left the channel relatively simple in form, lacking large woody debris (LWD) (Lisle and Napolitano, these proceedings). The increased rate of tree fall has significantly augmented the supply of LWD in the North Fork (Reid and Hilton, these proceedings). This increase in available LWD has been linked to the increase in pool availability observed in this study and by Lisle and Napolitano (these proceedings). However, my data suggested that the availability of pools associated with LWD had not increased after logging.

Differences in timing of assessments and differences in methodologies may in part explain this contradiction. Severe winter storms during 1990 and 1994 resulted in elevated rates of tree fall in the North Fork. However, during December 1995, an abnormally severe storm resulted in higher-than-usual tree fall (Reid and Hilton, these proceedings). The final habitat survey included in this report was completed in June 1995. Further, my habitat surveys included only those LWD that were in contact with the wetted perimeter of the channel during the summer low flow period. Reid and Hilton assessed all downed trees both in the riparian buffer strip and to a distance of

more than 200 m into uncut units. Exclusion of the LWD from my survey does not suggest that these pieces are not important components of the creek. Although much of the LWD contributed little to summer habitat complexity, this LWD may provide increased habitat complexity during winter high-flow periods, resulting in higher survival of juvenile salmonids and increased pool availability during the summer.

Stream temperatures in the North Fork in general were higher than stream temperature in the South Fork throughout the year. Increases in stream temperature have been widely observed after timber harvest (Brown and Krygier 1970, Holtby 1988, Meehan 1970). However, in the absence of data for pre-logging stream temperatures, it is impossible to determine whether logging resulted in higher temperatures in the North Fork. The increase in water temperature was small and the range of temperatures observed within the North Fork is within the tolerable range for salmonids.

The results of this study identified no dramatic short-term changes in the abundance of aquatic vertebrates directly related to logging. However, these results are far from definitive. The extremely low statistical power of the statistical tests casts some doubt over their conclusions. Burns (1972) concluded that high interannual variation in salmonid numbers made it difficult to separate timber harvest impacts from natural variation. However, changes in habitat suggest possibility of changes in abundance. Decreased availability of shallow water habitat and increases in the density of yearling steelhead may negatively affect YOY steelhead in the North Fork as size-dependent interactions favor yearling steelhead in pool habitats (Harvey and Nakamoto 1997). Larval Pacific giant salamander density is strongly influenced by substrate composition and cover availability (Parker 1991). Changes in sediment storage associated with increased LWD input could benefit LPGS. Reduced amounts of sediment transported past debris jams promote scour downstream. Transport of fine sediments from these downstream areas will increase the availability of interstitial space between cobbles. Increased cover area provided by LWD and the scour of fine materials create habitat conditions favoring LPGS.

The abundance of coho in both creeks was variable until 1990 after which coho virtually disappeared. The extremely low population levels in both creeks combined with the low statistical power of the comparison results in a low probability of detecting logging-associated changes in the coho population. However, current increases in LWD and pool availability in the North Fork should benefit coho (Bisson and others 1988, Murphy and others 1986, Reeves and others 1989) although, competition between juvenile coho and steelhead in Caspar Creek may slow the recovery of coho (Harvey and Nakamoto 1996). Depressed population levels in both creeks suggest that conditions in both watersheds will not support coho and/or that factors outside the watersheds are influencing coho reproduction. Some of these factors may include poor winter and/or summer rearing habitat, or early emigration from the study reach. During those years when creek discharge was not sufficient for operation of the fish ladder over the V-notch weirs, the creeks were largely inaccessible to adults.

The increase in pool availability is closely related to the increased amount of LWD in the channel. The price of the significant increases in LWD input associated with severe winter storms may be that fewer logs are left to contribute in future years. The volume of LWD may be reduced as current LWD decays and is transported downstream. The current rate of LWD input from the riparian zone may decrease as reserves are depleted and trees become more wind firm. Other trees in the riparian zone may reach sizes large enough to form pools (> 20 cm diameter) within 25 years (Beechie and Sibley 1997). However, it is unlikely that these small trees will contribute enough LWD to offset losses. Increased summer flow is expected to disappear within 5 years after logging (Keppeler and Ziemer 1990). It would appear that over a longer time scale, habitat conditions and the aquatic vertebrates have not benefited from logging operations in the North Fork.

Acknowledgments

Lynn Decker initiated this study. Mike Arnold, Jay Arnold, Amy Barg, Jess Bednar, Bill Collins, Dave Fuller, Dr. Bret Harvey, Garth Hodgson, Caroline Houle-Stringall, Mike McCain, Heather Pert, Jim Simondet, Karen West, and others provided field assistance. Liz Keppeler assisted in coordinating field crews. I thank Dr. Bret Harvey, Sue Hilton, Wendy Jones, Jack Lewis, and Dr. Tom Lisle for their insightful reviews of earlier versions of this paper.

References

- Beechie, T.J.; Sibley T.H. 1997. **Relationships between channel characteristics, woody debris, and fish habitat in northwestern Washington streams.** Transactions of the American Fisheries Society 126: 217-229.
- Bilby, R.E.; Ward, J.V. 1991. **Characteristics and function of large woody debris in streams draining old-growth, clear-cut, and second-growth forests in southwestern Washington.** Canadian Journal of Fisheries and Aquatic Sciences. 48: 2499-2508.
- Bisson, P.A.; Sedell, J.R. 1984. **Salmonid populations in streams in clearcut vs. old-growth forests of western Washington.** In: Meehan, W.R.; Merrell, T.R. Jr.; Hanly, T.A., ed. Fish and wildlife relationships in old-growth forests, proceedings of a symposium held April 1982, Juneau, AK. Juneau, AK: American Institute Fish Research Biology: 121-129.
- Bisson, P.A.; Sullivan, K.; Nielsen, J.L. 1988. **Channel hydraulics, habitat use, and body form of juvenile coho salmon, steelhead, and cutthroat trout in streams.** Transactions of the American Fisheries Society 117: 262-273.
- Brown, G.W.; Krygier, J.T. 1970. **Effects of clear cutting on stream temperatures.** Water Resources Research 6: 1133-1139.
- Burns, J.W. 1972. **Some effects of logging and associated road construction on northern California streams.** Transactions of the American Fisheries Society 101: 1-17.
- Harvey, B.C.; Nakamoto, R.J. 1996. **Effect of steelhead density on growth of coho salmon in a small coastal California stream.** Transactions of the American Fisheries Society 125: 237-243.
- Harvey, B.C.; Nakamoto, R.J. 1997. **Habitat-dependent interactions between two size-classes of juvenile steelhead in a small stream.** Canadian Journal of Fisheries and Aquatic Sciences 54: 27-31.
- Hawkins, C.P.; Murphy, M.L.; Anderson, N.H.; Wilzbach, M.A. 1983. **Density of fish and salamanders in relation to riparian canopy and physical habitat in streams of the northwestern United States.** Canadian Journal of Fisheries and Aquatic Sciences 40: 1173-1184.

- Holtby, L.B. 1988. **Effects of logging on stream temperatures in Carnation Creek, British Columbia, and associated impacts on coho salmon (*Oncorhynchus kisutch*)**. Canadian Journal of Fisheries and Aquatic Sciences 45: 502-515.
- Keppeler, E.T.; Ziemer, R.R. 1990. **Logging effects on streamflow: water yield and summer low flows at Caspar Creek in Northwestern California**. Water Resources Research 26: 1669-1679.
- Lisle, T.E. 1989. **Sediment transport and resulting deposition in spawning gravels, north coastal California**. Water Resources Research 25: 1303-1319.
- McCain, M.; Fuller, D.; Decker, L.; Overton, K. 1990. **Stream habitat classification and inventory procedures for northern California**. FHR Currents: R-5's Fish Habitat Relationships Technical Bulletin. No. 1; 15 p.
- McIntosh, B.A.; Sedell, J.R.; Smith, J.E.; Wissmar, R.C.; Clarke, S.E.; Reeves, G.H.; Brown, L.A. 1993. **Management history of eastside ecosystems: changes in fish habitat over 50 years, 1935-1992**. In: Hessburg, P.F., ed., Eastside forest ecosystem health assessment. Volume III, Assessment. Wenatchee, WA: Forest Service, U.S. Department of Agriculture; 291-483.
- Meehan, W.R. 1970. **Some effects of shade cover on stream temperature in southeast Alaska**. Res. Note PNW-113. Portland, OR: Pacific Northwest Research Station, Forest Service, U.S. Department of Agriculture; 9 p.
- Murphy, M.L.; Hall, J.D. 1981. **Varied effects of clear-cut logging on predators and their habitat in small streams of the Cascade Mountains, Oregon**. Canadian Journal Fisheries and Aquatic Sciences 38: 137-145.
- Murphy, M.L.; Heifetz, J.; Johnson, S.W.; Koski, K.V.; Thedinga, J.F. 1986. **Effects of clear-cut logging with and without buffer strips on juvenile salmonids in Alaskan streams**. Canadian Journal of Fisheries and Aquatic Sciences 43: 1521-1533.
- Newbold, J.D.; Erman, D.C.; Roby, K.B. 1980. **Effects of logging on macroinvertebrates in streams with and without buffer strips**. Canadian Journal of Fisheries and Aquatic Sciences 37: 1076-1085.
- Parker, M.S. 1991. **Relationship between cover availability and larval Pacific giant salamander density**. Journal of Herpetology 25: 357-361.
- Ralph, S.C., Poole, G.C.; Conquest, L.L.; Naiman, R.J. 1994. **Stream channel condition and instream habitat in logged and unlogged basins of western Washington**. Canadian Journal of Fisheries and Aquatic Sciences 51: 37-51.
- Reeves, G.H., Everest, F.H.; Nickelson, T.E. 1989. **Identification of physical habitats limiting the production of coho salmon in western Oregon and Washington**. Gen. Tech. Rep. PNW-113. Portland, OR: Pacific Northwest Research Station, Forest Service, U.S. Department of Agriculture; 18 p.
- Reiser, D.W.; White, R.G. 1988. **Effects of two sediment size-classes on survival of steelhead and chinook salmon eggs**. North American Journal of Fisheries Management 8: 432-437.
- Stewart-Oaten, A.; Murdoch, W.W.; Parker, K.R. 1986. **Environmental impact assessment: "pseudoreplication" in time?** Ecology 67: 929-940.
- Thedinga, J.F.; Murphy, M.L.; Heifetz, J.; Koski, K.V.; Johnson, S.W. 1989. **Effects of logging on size and age composition of juvenile coho salmon (*Oncorhynchus kisutch*) and density of presmolts in southeast Alaska streams**. Canadian Journal of Fisheries and Aquatic Sciences 46: 1383-1391.
- Wright, K.A.; Sendek, K.H.; Rice, R.M.; Thomas, R.B. 1990. **Logging effects on streamflow: storm runoff at Caspar Creek in northwestern California**. Water Resources Research 26: 1657-1667.

Persistence of Historical Logging Impacts on Channel Form in Mainstem North Fork Caspar Creek¹

Michael B. Napolitano²

Abstract: *The old-growth redwood forest of North Fork Caspar Creek was clear-cut logged between 1860 and 1904. Transportation of logs involved construction of a splash dam in the headwaters of North Fork Caspar Creek. Water stored behind the dam was released during large storms to enable log drives. Before log drives could be conducted, the stream channel had to be prepared by removing all obstructions, including large woody debris jams, from the channel. Comparison of present-day woody debris loading on North Fork Caspar Creek (24 kg m⁻²) to physically similar streams in old-growth redwood basins (49 to 268 kg m⁻²) suggests that wood-loading and stability were greatly diminished by historical logging activities and change to second-growth cover. These changes are important, as woody debris creates large-volume, long-term sediment storage sites and diverse aquatic habitat conditions. Although historical logging appears to have caused lasting channel changes, including channel incision, simplification of form, and reduction in sediment storage capability, the significance of habitat-related changes remains unclear.*

Keller and Tally (1979), in a study of the role of woody debris in steep, headwaters streams draining old-growth redwood forests, found that debris provides: (a) a stepped channel profile where a large proportion of the stream's total energy is dissipated locally at plunge pools below debris dams; (b) stable channel roughness elements that provide large-volume, long-term sediment storage sites (often stable for hundreds of years), effectively buffering the channel from infrequent large sediment inflows; and (c) stable channel structure that creates a diverse assemblage of channel morphologies and flow conditions.

Stable and diverse channel form is often associated with high-quality fish habitat. Physical factors (stream order, discharge, valley width, channel type, channel slope), woody debris input processes, and the size of debris pieces interact to control frequency, distribution, and stability of in-stream woody debris over time (Keller and others 1981). The influence of woody debris on channel form and process is directly related to its amount per unit length (debris loading), distribution, and stability over time.

To evaluate whether historical logging has caused persistent changes in channel form, woody debris loading, and stability, I analyzed: (a) research regarding the effect of woody debris on channel form and function in streams draining second- and old-growth redwood forest; (b) history of 19th- century logging activities at Caspar Creek; and (c) field evidence for historical disturbance or

removal of wood from North Fork Caspar Creek. This paper describes analysis of these data and discusses probable channel response to 19th- century logging activities.

Site Description

The mainstem channel of North Fork Caspar Creek, located in Mendocino County, California, is a steep (slope = 0.02), perennial, gravel-bed stream that is confined within a deeply-incised inner gorge. Position of bank-side trees and occurrence of large woody debris strongly influence channel position, variability in form, and width. Most sediment within the active channel is stored: (a) as localized deposits associated with jams of large woody debris; and (b) along short reaches of channel that are aggrading and widening in response to adjacent recent landslides. Gravel bars in the mainstem channel are unvegetated or covered with short-lived hydrophytes. Valley fill terraces define one or both channel banks along most of the channel length and become increasingly common downstream. Old-growth stumps in growth position on many valley fills confirm that some terraces were deposited at least hundreds of years ago, and that bank erosion and channel migration rates have subsequently been very low.

Comparison of North Fork Caspar Creek to Similar Streams in Old-Growth Coast Redwood Forest

Research by Tally (1980) demonstrates that much of the variability in debris loading along a particular stream draining an old-growth redwood forest is related to frequency of "large diameter redwood trees" (*table 1*) that are located near the channel. When physical input factors are uniform, debris loading is primarily a function of tree frequency, and therefore, physically similar channels should have comparable debris loading given similar forest cover.

Before 19th-century logging, tree frequency on North Fork Caspar Creek is likely to have been within the range for steep mountain streams (e.g., those without extensive floodplains) in old-growth forests that were surveyed by Tally (1980). Tree frequency along these streams varies from 26 to 68 trees per hectare. Keller and others (1981) compared several streams in second- and old-growth redwood basins to assess how the influence of woody debris on channel form and process may be altered in second-growth basins (*table 2*). North Fork Caspar Creek was one of the second-growth basins studied. Keller and others (1981) estimated debris loading of 21 to 24 kg m⁻² in North Fork Caspar Creek. Of the old-growth streams studied by Keller, upper Little Lost Man Creek is the most similar to North Fork

¹ An abbreviated version of this paper was presented at the Conference on Coastal Watersheds: The Caspar Creek Story, May 6, 1998, Ukiah, California

² Environmental Scientist, San Francisco Bay Regional Water Quality Control Board, 1515 Clay Street, 14th Floor, Oakland, CA 94612 (mbn@rb2.swrcb.ca.gov)

Table 1—Large woody debris loading in streams draining old-growth redwood forests. (Source: Tally 1980).

Stream	Reach	Debris loading (kg m ⁻²)	Number of large redwoods within 50 m channel	Floodplain
Hayes Creek		170	68	None
Little Lost Man Creek	Upper	141	52	None
	Middle	268	40	None
	Lower	49	26	None
Prairie Creek	Hope Creek	218	80	Minor
	Little Creek	12	25	Yes
	Forked Creek	13	21	Yes
	Zig Zag No. 2	22	25	Yes
	Natural Tunnel	106	41	Minor
	Brown Creek	85	75	None
	Campground	20	32	Yes

r² = 0.88 for debris loading vs. large redwood frequency.

Table 2—Channel attributes for streams in second- and old-growth redwood forests. (Source: Keller and others 1981).

	Second-growth			Old-growth								
	North Fork Caspar Creek upper/lower	Lost Man Creek	Larry Damm Creek	Hayes Creek	Little Lost Man Creek upper/lower	PRAIRIE CREEK						
						Hope Creek reach	Little Creek reach	Forked Creek reach	Zig Zag No. 2 reach	Natural Tunnel reach	Brown Creek reach	Campground reach
Basin area (km ²)	1.6/3.9	1.1	3.7	1.5	3.5/9.1	0.7	3.5	6.6	8.2	11.2	16.7	27.2
Stream order	2/2	2	3	2	2/2	2	2	2	2	2	3	4
Slope	.016/.013	.048	.014	.120	.033/.048	.020	.014	.012	.009	.010	.010	.005
Debris loading (kg m ⁻²)	21/24	105	76	170	142/49	218	12.3	13.1	21.7	106	84.8	19.6
Pool to pool spacing (by channel widths)	3.5/3.8	4.1	2.2	2.4	1.9/1.8	6.2	4.7	2.6	6.6	2.7	6.0	4.0
Area in pools (pct)	24/36	33	27	12	22/18	49	34	46	36	41	26	25
Area in riffles (pct)	30/30	25	14	26	15/21	21	46	49	20	15	18	25
Area in debris-stored sediment (pct)	44/34	43	59	40	39/39	30	18	30	15	21	29	13
Area in undercut banks (pct)	2/1	4	2	4	3/1	1	4	3	4	1	<1	1
Pool morphology influenced by debris (pct)	82/43	79	59	83	100/90	86	71	87	50	80	67	50
Debris controlled drop in elevation (pct)	57/37	69	17	38	59/30	43	27	34	8	<1	18	<1

NOTE: Total percentages in stream environments may be less than or greater than 100 percent owing to overlaps between units (such as pools which contain debris-stored sediment).

Caspar Creek (table 3). Both are steep, second-order, gravel-bedded streams with narrow valleys, similar drainage area, channel width, and slope. Therefore, physical factors affecting woody debris input and loading should be similar. There are between 26 and 52 large redwood trees per hectare along Little Lost Man Creek; the creek contains 49 to 268 kilograms of wood per square meter of stream (table 4) or two to seven times more than in North Fork Caspar Creek. Therefore, it appears that debris loading, and consequently the influence of woody debris on channel form and process, was much greater in North Fork Caspar Creek before the 19th- century logging, compared to present conditions. Much higher debris loading in Little Lost Man Creek provides significantly greater debris-related sediment storage capacity (table 4). For example, log jams in Little Lost Man Creek store about five times as much sediment, and have approximately 20 times as much unfilled storage capacity as in North Fork Caspar Creek.

Woody debris jams in streams that drain old-growth forests are also quite stable. Large trees, found growing on pieces of debris which comprise the jams, are often more than 100 years old (Keller and Tally 1979). Considering the stability of debris jams in old-growth streams, Keller and Tally (1979) concluded that debris-related sediment storage capacity in Little Lost Man Creek (and other old-growth streams) provides an important buffer system for the channel by allowing infrequent large-magnitude sediment inputs to be stored in jams and released slowly over time. In contrast, debris-related storage capacity in North Fork Caspar Creek is less than 50 t km⁻² (table 4), the presence of many collapsed or partially collapsed jams and the lack of mature trees growing through the debris pieces suggest that the debris jams are dynamic, short-lived features (Napolitano 1996; table 5). Historical logging activities may be the cause for these differences.

History of 19th-Century Logging at Caspar Creek

Caspar Creek was first logged in 1860, and most of the watershed was clearcut and burned between 1864 and the mid-1890's (Wurm 1986). Caspar Lumber Company records indicate that redwoods logged in the Caspar Creek watershed typically ranged between 0.8

Table 4—Comparison of characteristics of Upper Little Lost Man Creek and North Fork Caspar Creek¹.

Stream	Forest cover	Woody debris loading	Sediment storage	Available storage ²
		kg m ⁻²	t km ⁻²	t km ⁻²
Upper Little Lost Man	Old-growth	141	1795 ³	1010 ³
North Fork Caspar	Second-growth	24	340 ⁴	< 50 ⁴

¹ All Little Lost Man Creek data, and debris loading data for North Fork Caspar Creek are from Keller and others (1981).

² Remaining sediment storage capacity in debris jams.

³ Based on data in Keller and others (1981), and assuming sediment storage per unit drainage area is similar in upper and lower Little Lost Man Creek and bulk density of sediment in storage is approximately 1.8 t m⁻³.

⁴ North Fork Caspar Creek sediment storage based on data collected in summer 1987.

and 2.5 m in diameter. Cut logs were floated downstream to the company mill located on the coast. To make this possible, a logging splash dam was constructed near the headwaters of the North Fork Caspar Creek (Jackson 1987a). The water stored behind the dam was released during large storms to increase streamflow enough to enable log drives. Before log drives could be conducted, a stream channel had to be “improved” by “removal or blasting of boulders, large rocks, leaning trees, sunken logs or obstructions of any kind” (Brown 1936). During each log drive thousands of logs were transported down the creek (Jackson 1987b).

Field Evidence of Channel Improvement and Log Drives

Evidence of channel preparation for log drives along the mainstem North Fork Caspar Creek can be found by examining in-place old-growth stumps on valley fills. The old-growth redwood stumps are commonly obscured by mature stump sprouts or by shrubs growing through the stump. It is likely, therefore, that old-growth stumps are present elsewhere along the creek where they have not been recognized. As the valley width is narrow (3 to 20 m) along most of North Fork Caspar Creek, stumps were cut flush with the ground surface to avoid snagging of floated logs during drives. All other old-growth stumps in the basin (e.g., those farther from the channel and on hillslopes) were cut well above the root swell, several meters above ground surface, because sawyers were paid by the small diameter of each log that they cut (Jackson 1987a).

Direct evidence of removal of woody debris elements from the channel of North Fork Caspar Creek is difficult to find. Characteristics of woody debris within the active channel, however, suggest that logs were removed or blasted. For example, almost without exception, the largest logs in the channel today are 0.5 m in diameter, approximately the same diameter, as the largest second-growth trees within the basin. In one location, an old-growth trunk is protruding from the bank of a valley fill deposit. This trunk had been sawed obliquely, to be flush with the ground surface of the

Table 3—Channel attributes of Upper Little Lost Man Creek¹ and North Fork Caspar Creek.

Stream	Forest cover	Basin area	Slope	Channel sinuosity	Channel width ²	Channel margins
		km ²	m/m	m/m	m	
Upper Little Lost Man	Old-growth	3.5	0.03	1.1	6.4	Hillslopes or narrow valley flat
North Fork Caspar	Second-growth	3.8	0.02	1.1	5.3	Narrow valley flat and/or hillslopes

¹ Data for Little Lost Man Creek from Keller and Tally (1979)

² Mean channel width = channel area per centerline channel length

Table 5—Large debris jams in North Fork Caspar Creek having sediment storage volume $\geq 25\text{m}^3$.

Reach name length (meters)	Geomorphic map I.D	Location	Debris jam formed (water year)	1987 sediment m^3	1985-1987 change in storage ¹	Evidence from maps ¹
A (1120)	O1	80 m upstream of xs 9	1980	53	0-10 m^3 increase	Jam formed in 1980, as noted in 1980 xs survey; bars and some LWD first depicted on 1986 map
	O2	25 m upstream of xs 25	1984 or 1985	34	20-30 m^3 increase	LWD jam but no bars on 1985 map; xs 26 end-pins missing in 1986; step and small bar shown on 1986 map
	O3	15 m downstream of xs 28	Before 1979 ²	71	0-10 m^3 increase	Few LWD pieces and no gravel bars on 1985 map; long bar on 1986 map
	O5	8 m upstream of xs 37	Before 1979 ²	58	0-10 m^3 increase	Most bars and LWD are depicted on 1985 map; no significant changes in 1986-87
	O6	2 m downstream of xs 42	Between 1979 and 1985 ³	73	0-10 m^3 decrease	Stepping noted 1985; step breached 1986, but most stored sediment remained in jam
	O7	15 m upstream of xs 43	Before 1979 ²	47	No change	No changes evident 1985-87
F (695)	O14	16 m upstream of xs 50	Between 1979 and 1985 ³	77	No change	No changes evident 1985-87
	O17	17 m downstream of xs 56	Before 1979 ²	32	0-20 m^3 decrease	Step collapsed in 1986, but most stored sediment remained in jam
	O24	26 m upstream of xs 60	Before 1979 ²	26	No change	No changes evident 1985-87
L (590)	O33	16 m downstream of xs 74	Before 1979 ²	33	0-20 m^3 decrease	No changes evident on maps; 1986-88 scour at xs 74 suggests a decrease in storage
	O35	17 m downstream of xs 76	Between 1979 and 1985 ³	27	No change	No changes evident 1985-87

Total storage as Large Jams (530 m^3)¹ Based on analysis large woody debris maps (Unpublished USDA Forest Service maps) prepared in 1985 and 1986, and geomorphic maps prepared in 1987 (Napolitano 1996).² Based on review of cross-section field notes prepared in July 1979, which state whether large woody debris was present, and if it created a backwater at a cross-section.³ No backwater effect from woody debris noted in cross-section field notes prepared in July 1979; debris jam shown on 1985 large woody debris maps.

valley fill deposit. Before being cut, it probably extended across the valley width and obstructed streamflow, and thus would have hindered efforts to float logs downstream. Other smaller old-growth logs are similarly oriented and partially buried within the same valley fill deposit a few meters upstream, suggesting that there may have originally been a debris jam present at the site.

Channel Response to 19th-Century Logging Activities

Channel erosion and incision would be promoted by increased peak flows associated with splash dam releases and abrasion caused by repeated transport of thousands of logs. A large fraction of the sediment stored in debris-jam backwaters would probably have been liberated because the logs that had stabilized and trapped the sediment were removed during channel preparation. Considering that the diameters of trees logged in Caspar Creek generally ranged between 0.8 and 2.5 m, the streambed may have degraded substantially where jams extended across the channel. Most of the sediment stored in valley fills, however, probably was not eroded because of the resistance to erosion afforded by large and extensive root networks of the old-growth trees growing on the fills.

Before the log drives, the mainstem channel is likely to have more closely resembled the present-day stream reach located upstream of the splash dam backwater. In that reach, the channel is only slightly entrenched (typically channel banks are less than 0.6 m high) and has a much higher width-to-depth ratio than below the splash dam. Its planform, typically, is anastomosing with a well-defined main channel and auxiliary high-flow channels.

Under present conditions, the largest second-growth trunks in the channel in the reach upstream of the splash dam do not appear to be mobilized by frequently occurring peak flows. Interactions between the forest and the channel in that reach are more likely to resemble those before the initial logging than would the interactions downstream where the logs are more easily mobilized.

Channel morphology in the reach above the splash-dam resembles that of Little Lost Man Creek, the old-growth channel in Redwood National Park which is similar to North Fork Caspar Creek in setting and physical watershed characteristics.

Lack of well-developed soil horizons on the valley fills suggests that the fills were frequently flooded, at least as recently as several hundred years ago (i.e., the time it would take for a A horizon to form). The fact that old-growth trees on the valley fills were cut flush with the ground surface suggests that those preparing the channel for log drives believed this was necessary to avoid snagging cut logs during drives, also suggesting that high flows regularly inundated the terrace surface. Bank tops along North Fork Caspar Creek are typically 1 to 2 m above the channel thalweg, much greater than stages associated with common flows (i.e., a stage of about 0.6 m

has a recurrence interval of 6 yr at gaging Station A). This suggests that valley fills have been converted from large-volume, long-term sediment sinks (floodplains) to substantial sediment sources (terraces) as a result of channel incision in response to removal of old-growth debris jams from the channel during 19th-century logging activities. Conversion of the floodplains to terraces signifies a major change of trends in valley sediment storage and a pervasive alteration in the sediment budget for the basin.

The channel has not recovered its previous morphology because jams in the channel are now less stable, stepping is less pronounced with smaller diameter trunks, and the resistance to bank erosion afforded by second-growth trees on the valley fills limits lateral migration. These factors cause the channel to remain entrenched, and to have a narrower width-to-depth ratio than the reach above the splash dam. Comparison of second-growth to old-growth channels also shows that pools are much more frequent and their average depth is greater in the old-growth channels (Keller and others 1981, Montgomery and others 1995). Therefore, it is also likely that pools are less frequent and shallower in North Fork Caspar Creek as a result of historical logging activities. It is unlikely that North Fork Caspar Creek will recover its former morphology, however, until the former relationship between the size of woody debris and flow magnitude is reestablished.

References

- Brown, N.C. 1936. **Logging transportation**. New York: John F. Wiley and Sons; 327 p.
- Jackson, W. Francis, Historian and author, Mendocino, California. [In-person conversation with Michael B. Napolitano]. July 1987.
- Jackson, W. Francis, Historian and author, Mendocino, California. [In-person conversation with Michael B. Napolitano]. August 1987.
- Keller, E.A.; MacDonald, A.; Tally, T. 1981. **Streams in the coastal redwood environment: the role of large organic debris**. In: Coats, R.N., ed. Proceedings, Symposium on watershed rehabilitation in Redwood National Park and other Pacific coastal areas; 1981 August 25–28; Arcata, CA. Sacramento, CA: Center for Natural Resources Studies of JMI, Inc.; 161-176.
- Keller, E.A.; Tally, T. 1979. **Effects of large organic debris on channel form and fluvial processes in the coastal redwood environment**. In: Rhodes, D.D.; Williams, G.P., eds. Adjustments in the fluvial system. Dubuque, IA: Kendall Hunt Publications; 168-198.
- Montgomery, D.R.; Buffington, J.M.; Smith, R.D.; Schmidt, K.M.; Pess, G. 1995. **Pool spacing in forest channels**. *Water Resources Research* 31(4): 1097-1105.
- Napolitano, M.B. 1996. **Sediment transport and storage in North Fork Caspar Creek, Mendocino County, California: water years 1980-1988**. Arcata, CA: Humboldt State University; 148 p. M.S. thesis.
- Tally, T. 1980. **The effects of geology and large organic debris on stream channel morphology and processes for streams flowing through old-growth redwood forests in northwestern California**. Santa Barbara, CA: University of California at Santa Barbara; 273 p. PhD. dissertation.
- Wurm, T. 1986. **Mallets on the Mendocino coast: Caspar Lumber Company, railroads and steamships**. Glendale, CA: Trans-Anglo Books.

Logging Impacts of the 1970's vs. the 1990's in the Caspar Creek Watershed¹

Peter H. Cafferata² and Thomas E. Spittler³

Abstract: *The Caspar Creek watershed study provides resource professionals with information regarding the impacts of timber operations conducted under varying forest practices on sensitive aquatic habitats. In the South Fork watershed, roads were constructed near watercourse channels in the 1960's, and the watershed was selectively logged using tractors during the early 1970's. Subwatersheds in the North Fork were clearcut from 1985 to 1991 using predominantly cable yarding and roads located high on ridges. Numerous landslides were documented after road construction and logging in the South Fork owing to inadequate road, skid trail, and landing design, placement, and construction. In contrast, the size and number of landslides after timber operations in the North Fork to date have been similar in logged and unlogged units. Considerably more hillslope erosion and sediment yield have also been documented after logging operations in the South Fork, when compared to the North Fork. An analysis of the storm events associated with documented landslides showed that high 3-day or 10-day precipitation totals in combination with moderately high 1-day amounts have been more important than very high 1-day totals alone in triggering debris sliding at Caspar Creek. Storm sequences meeting the criteria required for causing documented landslides were found to have occurred in all phases of the 36-year study, with the greatest number occurring in water year 1998. Numerous large landslides associated with the road system in the South Fork occurred in early 1998, indicating that "legacy" roads continue to be significant sources of sediment decades after they were constructed.*

The impacts of harvesting and road construction in a second-growth redwood/Douglas-fir forest have been studied for 36 years in the Caspar Creek watershed. This allows us to compare the impacts from the first phase of the project, completed before the implementation of the modern Forest Practice Rules in California, with those associated with considerably improved forestry practices. Specifically, in the South Fork, roads were constructed in 1967, and the entire basin was selectively harvested from 1971 to 1973, before the enactment of the Z'berg Nejedly Forest Practice Act of 1973. Approximately 6.8 km (4.2 mi) of road were built low on the slopes in the watershed, much of it adjacent to the South Fork channel, and tractors were used to skid logs to low-slope landings. Some of the skid trails were built in small stream channels. In contrast, 47.8 percent of the North Fork, within 10 nested subwatersheds, was clearcut from 1985 to 1992 using 11.4 km (7.1 mi) of existing roads and 8.4 km (5.2 mi) of new roads located high

on the ridges (Preface, fig. 2, these proceedings). The steeper slopes were cable yarded. This long-term instream monitoring study provides resource professionals in California with information regarding the impacts of timber operations with varying forest practices on sensitive aquatic habitats.

In this paper, we present a discussion of the geology and geomorphology present in the Caspar Creek drainage, as well as a summary of the major erosional sources which have followed logging in the gaged portions of each tributary. Additionally, we compare and contrast rainfall and runoff events that occurred during both phases of the study. A summary of the sediment yields documented during the life of the study is presented, and changes in sediment generation attributable to improved forest practices are discussed. Finally, recommendations are offered to forest managers regarding the applicability of Caspar Creek results to other California watersheds.

Geology and Geomorphology Physiography

The North Fork of Caspar Creek above its weir drains a watershed of 473 ha (1,169 ac), in northern California, whereas the area above the South Fork weir is approximately 424 ha (1,047 ac). These small watersheds, located inland from the central Mendocino County coast, are about 11 km (7 mi) southeast of Fort Bragg. The low point of each experimental watershed is at its weir, 85 m (275 ft) for the North Fork and 50 m (160 ft) for the South Fork, with the high points 310 m (1,020 ft) and 320 m (1,057 ft), respectively.

Geology

Both watersheds are underlain by the Coastal Belt of the Franciscan Complex (Kilbourne 1982, 1983; Kilbourne and Mata-Sol 1983). Well-consolidated marine sedimentary sandstone with intergranular clay and silt (graywacke) and feldspathic sandstone, with lesser amounts of siltstone, mudstone, and conglomerate, are the dominant rock types. The sandstones are poorly bedded to massive, and moderately well consolidated. Individual exposures range from coarsely jointed sandstone that is moderately hard and strong to highly fractured to sheared rock that exhibits low strength.

Alluvium of Holocene age is locally present in both watersheds. A significant accumulation of this material is present in the upper portion of the North Fork watershed. The alluvium consists of loose to somewhat indurated, poorly sorted sands, gravels, and silts that were deposited behind barriers or locally along low-gradient segments of the stream channels. An extensive area of alluvium was deposited behind an ancient landslide dam in the North Fork. The

¹ An abbreviated version of this paper was presented at the Conference on Coastal Watersheds: The Caspar Creek Story, May 6, 1998, Ukiah, California.

² Forest Hydrologist, California Department of Forestry and Fire Protection, PO Box 944246, Sacramento, CA 94244. (pete_cafferata@fire.ca.gov)

³ Senior Engineering Geologist, California Department of Conservation, Division of Mines and Geology, PO Box 670, Santa Rosa, CA. 95402. (tom_spittler@fire.ca.gov)

remnant of the landslide dam is an inclined (depositional inclination) deposit of poorly sorted sand, silt, and gravel that forms a perched bench on the north bank. The geometry of the remaining sediment indicates that this old landslide transported on the order of 1 to 5 million cubic meters of material.

Geomorphology

Both the North Fork and South Fork of Caspar Creek flow in relatively narrow, bedrock-controlled stream channels. The upper portion of the North Fork of Caspar Creek flows in a narrow gully through Holocene alluvium that was deposited behind the landslide dam. Carbon-14 (^{14}C) dating of carbonaceous material, found by Dr. Stephen Reneau (1989) in the alluvium upstream from the landslide dam, indicates that this material slowly filled the valley beginning about 7,000 years before present (BP) through at least the late Holocene. Deposition stopped only recently, after which renewed downcutting occurred. This indicates to us that the broad (approximately 100 m [330 ft] wide) debris flow deposits formed a long-lasting dam that resisted downcutting for thousands of years.

Logging of the old-growth forest in the Caspar Creek watershed occurred between the 1860's and 1904. All large, accessible trees that would generate high-quality forest products were felled, topped, and limbed on the slopes. Included in the harvest were the trees that lined the stream channels and all partially buried logs and other structural features that could impede the transport of logs down the main channels during future floods. After the limbs and tops had dried (and the logs had lost a great deal of water weight), the watersheds were burned to clear away the logging slash. The resistance to fire of the old-growth redwood protected the logs from immolation. Fire scars are still visible on old-growth trees that were not harvested. After burning, the bucked logs were skidded to the main stream channels by oxen (a small percentage of the North Fork watershed was logged later starting about 1900 with steam donkeys). Small stream channels were used as skid roads, with corduroy logs half buried, heavily greased, and evenly spaced at intervals equal to the stride of the oxen that were teamed to pull the log trains.

During this time dams were constructed across steep, narrow reaches in the headwaters of the two forks of Caspar Creek. Remnants of the splash dam in the North Fork are visible along the steep, narrow channel at the old landslide dam. During the winter, when the streams were at flood stage and the reservoirs behind the dams were full, the gates would be opened and the resulting flood would raft the accumulated logs to the mill at the mouth of Caspar Creek. The transport of logs down the streams continued for roughly 25 years until most of the watershed had been logged (Wurm 1986).

It is clear that the artificial floods and the removal of the riparian vegetation and in-channel large woody debris had a profound impact on channel geometry, stream bank stability, and sediment discharge. Napolitano (1996) documents that the depletion of large woody debris from the stream channel, caused by the clearing and flooding, was so severe that the streams have not yet recovered. However, the consequences of the logging on the hillslopes did not persist. Other than a few remnants of corduroy

skid roads in small channels, little evidence of the original logging is still present. In fact, in the North Fork watershed, the majority of which was never logged with tractors, the well-preserved details of the surface morphology allow the geomorphic mapping of debris slides, debris flows, rotational landslides, disrupted, hummocky ground, and inner gorges.

The geomorphic mapping of the North Fork took place at intervals between 1986 and 1994. The upper portion of the watershed was field mapped using the published topographic map that was photographically enlarged to a scale of 1:6,000. The remainder of the North Fork was mapped using aerial photographs and limited field reconnaissance on a 1:12,000-scale, photographically enlarged topographic base. The quality of ground surface exposure in the North Fork allowed the landslides to be subdivided into five relative age classes (Spittler and McKittrick 1995): (1) fresh-appearing landslides that were most recently active within the past 20 years; (2) landslides that have affected the second-growth trees but have recovered to some degree—estimated to be from 20 to 120 years old; (3) landslides that have affected the old-growth trees or stumps, but have not affected the second-growth trees—estimated to be from 100 to 1,000 years old; (4) landslides that have not affected the old-growth trees or stumps but have well-defined surficial morphologies—estimated to be from 500 to several thousands of years old; and (5) geomorphic features with morphologies suggestive of landsliding but that are highly modified. These last features may be related to differential erosion of inhomogeneous bedrock, perched ancient erosional surfaces, or ancient landsliding.

In contrast to the logging history of the North Fork, the logging history of the South Fork of Caspar Creek has resulted in a significant impairment in our ability to map geomorphic features. Mapping was conducted by using aerial photographs taken for this project, and photos taken in 1975 after the more recent logging was completed. Field work was impeded by ground surface modifications and dense regeneration. The South Fork watershed was affected by a high degree of ground disturbance that occurred as a result of road construction in 1967 and tractor logging between 1971 and 1973, before the implementation of modern forest practices. This disturbance has modified surface features to the extent that only larger landslides, and those that occurred following the timber harvesting, are well defined. The landslide incidence and sediment yield data suggest that the ground disturbances affected more than our ability to map landslides. Although the South Fork was selectively logged, the persistence of the surface disruption during the 25 years since the logging was completed suggests to us that the recovery is very slow.

Within the North Fork watershed, only one small landslide⁴ was observed in the clearcut units of the North Fork of Caspar Creek between the beginning of logging in 1985 and the end of the geologic study in late 1994. This was a failure from a yarder landing in

⁴ Landslides are defined here as those greater than or equal to 76 m³ (100 yd³). Additional smaller features were also recorded.

subwatershed G that occurred during an unseasonable storm event in late May 1990. Of the 15 other landslides in the watershed that were fresh appearing, seven are associated with the existing roads across the upper slopes and eight occurred in areas not adjacent to roads. Other than the subwatershed G feature, landslides in the harvested blocks appear to predate the timber harvesting on the basis of the age of vegetation growing on the scars. Eight of the fresh-appearing landslides are larger than 0.2 ha (0.5 ac) (fig. 1). Of these, all but one are associated with the older roads. After the completion of the geologic study, a debris flow in the YZ subwatershed transported about 3,600 m³ (4,700 yd³) in January 1995. Seven other small failures have been documented in the North Fork since the start of 1995. Three small failures occurred in both clearcut blocks and areas outside of harvest units.⁵ In addition, one fill failure occurred that was associated with an existing road in a clearcut subwatershed.

Unlike the North Fork watershed, where only one small landslide was related to roads, skid trails, or landings constructed for the recent predominantly cable clearcut logging, almost all of the smaller, more recent landslides in the selectively cut South Fork watershed are associated with these types of disturbance features. Interpretation of aerial photographs of the South Fork of Caspar Creek from 1975 revealed 66 recently active landslides, all of which appear to be debris slides or debris flows. Of these, 35 are associated with roads, 12 with landings, and 16 with skid trails, with three not associated with ground disturbances and not within the area that was selectively logged. Seventeen of the post-logging landslides were larger than 0.2 ha (0.5 ac). Of these larger landslides, six are associated with roads, seven with landings, and three with skid trails; one is not associated with the timber operations (figs. 2, 3).

The number and relative sizes of post-harvesting landslides differ substantially between the North Fork and South Fork of Caspar Creek. Within the North Fork, 10 landslides have been reported to have occurred since the beginning of operations in 1985, including two in 1998. Of these, six are associated with logged units and four are in unlogged portions of the watershed. Only one landslide failed in the North Fork that exceeded 0.2 ha (0.5 ac). In contrast, during the first 8 years after the initiation of road construction within the South Fork watershed, 66 landslides, 17 of which are larger than 0.2 ha, failed.

During the El Niño storm year of 1997-1998, which is the winter of record for precipitation during the life of the Caspar Creek watershed study (greater than 2,030 mm [80 in.] total precipitation), only one small landslide was reported for recently logged or roaded units in the North Fork watershed. This slide feature is approximately 76 m³ (100 yd³) and occurred along the North Fork in a unit clearcut in 1990; it is located immediately above the streambank and is actually a reactivated slide mapped earlier in the study. Another slide of similar size took place in uncut tributary H (table 1). In contrast, landslides of 1376, 149, 68, 57, and 25 m³ (1800, 195, 89, 74, and 33 yd³) have been documented in

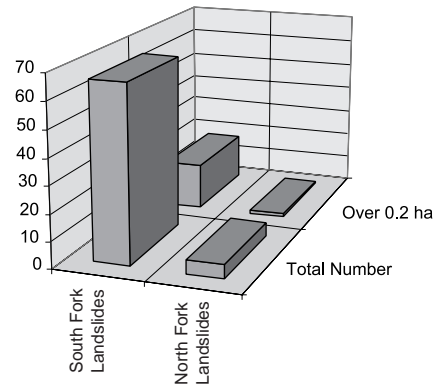

Figure 1—Comparison of the total number of landslides and number of landslides over 0.2 ha after timber harvesting activities in the North Fork (until 1996) and South Fork (until 1975) of Caspar Creek.

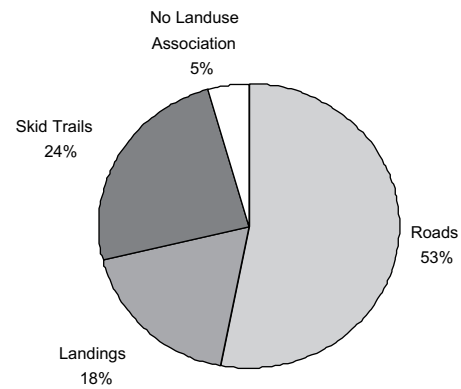

Figure 2—Distribution of all landslides after 1967 road construction and 1971-1973 logging as interpreted from 1975 aerial photographs, South Fork Caspar Creek.

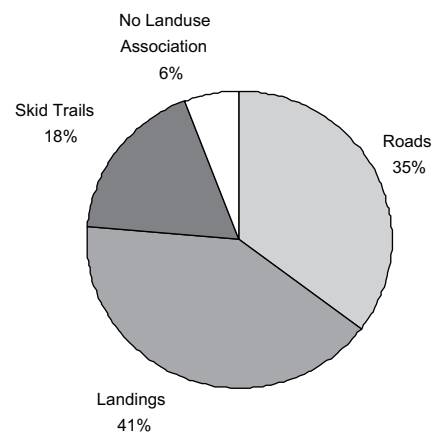

Figure 3—Distribution of landslides over 0.2 ha after 1967 road construction and 1971-1973 logging as interpreted from 1975 aerial photographs, South Fork Caspar Creek.

⁵ Data from North Fork Caspar Creek Large Event Inventory, supplied by Elizabeth Keppeler, USDA Forest Service, Pacific Southwest Research Station, Fort Bragg, California.

the South Fork watershed that were related to the old road system and have discharged substantial amounts of sediment into the stream. In addition, a 420-m³ (550-yd³) feature associated with the old skid trail network and an inner gorge slide of 168 m³ (220 yd³) not related to old roads or skid trails occurred (Keppeler 1998).

Hydrologic Considerations

Rainfall and Hillslope Failures

Rainfall characteristics are well-correlated with landslide initiation. Deep-seated failures are heavily influenced by seasonal precipitation amounts (Sidle and others 1985). In contrast, shallow rapid failures, such as the debris avalanches and debris slides that have occurred in the Caspar Creek watershed, are generally triggered by a critical combination of rainfall intensity and duration (Cannon and Ellen 1985). Intense rainfall can exceed the rate of hillslope drainage, causing the piezometric surface to rise and generating positive pore water pressures within the soil that can ultimately cause slope failure (Campbell 1975).

Timber operations can alter hillslope drainage patterns. Harvesting timber in a small swale in the North Fork of Caspar Creek elevated pore water pressures from 9 to 35 percent above background levels during the first 4 years after logging, but did not initiate slope failure. On slopes with known or suspected stability problems, however, additional pore water pressure generated by timber harvest may increase the risk of landsliding (Keppeler and others 1994). Mid-swale road construction along with timber harvest in the North Fork produced dramatic increases in pore water pressures in and up-slope of the road prism (Keppeler and Brown, these proceedings). LaHusen (1984) reported similar results in Redwood National Park. He documented greatly increased pore water pressures within roadfill

material, with a corresponding two- to five-fold decrease in hydraulic conductivity, and concluded that intense rainfall events can create pronounced "groundwater mounds" in road prisms that eventually culminate in debris flow initiation.

Campbell (1975) and Wieczorek and Sarmiento (1983) found that 25 to 38 cm (10 to 15 in.) of antecedent seasonal precipitation can ready a hillslope for debris slides. Once field capacity of the soil mantle has been reached, a storm with extreme 12- to 24-hour precipitation can cause shallow debris avalanche failure. For 24-hour storm duration, a failure threshold has been shown to occur at a rainfall intensity of 0.7 cm hr⁻¹ (0.3 in. hr⁻¹) in the part of the San Francisco Bay area with mean annual precipitation of more than 66 cm (26 in.) (Cannon and Ellen 1985), and a failure threshold of 0.43 cm hr⁻¹ (0.17 in. hr⁻¹) has been reported by Caine (1980) using data in the worldwide literature. Caine (1980) used published records of rainfall intensities and durations associated with shallow landsliding to develop a rainfall-debris flow threshold equation for durations from 10 minutes to 10 days.

Rainfall Records for Caspar Creek

Before we can draw valid conclusions regarding the relationship between landsliding and sediment generation with forestry practices, we must assess the number and relative sizes of stressing storms that occurred throughout the calibration period for both watersheds (water years 1963-1967), the South Fork road construction, logging, and recovery period (1968-1978), and the North Fork road construction, logging, and recovery period (1986-1998).

Daily precipitation values are available for the South Fork of Caspar Creek for hydrologic years 1963 through 1998.⁶ Goodridge (1997) provides rainfall depth duration frequency data for the South Fork Caspar Creek 620 station.⁷ From this information, we plotted

Table 1—Precipitation amounts from storm periods associated with known landslides greater than 76 m³ (100 yd³) in the North Fork of Caspar Creek (exact dates of landslides during storm events are assumed in some cases).

Slide date	Subwatershed	Slide Vol (m ³)	Slide Vol (yd ³)	1-Day Total (cm)	3-Day Total (cm)	5-Day Total (cm)	10-Day Total (cm)	API (cm)
March 31, 1974 ¹	L-not logged	3306	4324	6.17	11.79	17.63	20.09	17.30
Feb 16, 1986	L-not logged	1262	1650	4.95	11.94	15.95	16.13	16.92
May 27, 1990	G-logged	283	370	4.88	12.40	12.40	23.77	17.81
Jan 9, 1995	YZ-logged	3606	4715	5.97	15.62	19.71	23.67	20.80
March 14, 1995	A-not logged	306	400	5.11	11.38	15.98	25.58	20.07
March 14, 1995	G-logged	76	100	5.11	11.38	15.98	25.58	20.07
March 14, 1995	C-logged	130	170	5.11	11.38	15.98	25.58	20.07
Jan 24, 1996	E-logged	84	110	5.13	7.42	10.85	23.37	16.56
Dec 31, 1996	H-not logged	122	160	8.59	17.60	19.18	23.90	23.55
February 1998 ²	L-logged	76	100	—	—	—	—	—
March 22, 1998	H-not logged	103	135	5.08	12.57	12.57	12.62	15.16
Mean				5.74	12.59	15.53	21.14	18.52

¹The date of this slide feature was assumed based on large amounts of precipitation at the end of the month. Slide volume is from Rice and others (1979).

²The date of this feature is unknown, preventing the association of rainfall amounts with the landslide feature.

⁶ The hydrologic year is defined as beginning on August 1st for the Caspar Creek watershed. Daily precipitation values are determined from midnight to midnight.

⁷ Data missing from Goodridge (1997) were obtained from the USDA Forest Service's Pacific Southwest Research Station's Internet site (<http://www.rsl.psw.fs.fed.us/projects/water/caspar.html>).

the 1-, 3-, 5-, and 10-day annual maximum rainfall totals to determine the frequency and size of stressing storm events over the life of the study. For example, the 1-day annual maximums are displayed in *figure 4*.

In Goodridge's (1997) analysis, 11.07 cm (4.36 in.) of precipitation over a 1-day period constitutes a 5-year return period event, 12.88 cm (5.07 in.) represents a 10-year 1-day event, and 16.59 cm (6.53 in.) is the 50-year 1-day event. Before any modern disturbances in either the South Fork or the North Fork, 5-year rainfall events occurred in water years 1964, 1965, and 1966. After road construction in the South Fork, another 5-year stressing storm occurred in 1969. An event of approximately this magnitude occurred in 1985, before the start of logging in the North Fork. The highest 1-day precipitation total during the period of the study is 12.75 cm (5.02 in.) and occurred in water year 1998, approximately 7 years after completion of logging in the North Fork. This is only slightly less than a 10-year event. Therefore, it appears that only one 1-day duration storm total approached the 10-year recurrence interval during the 36-year study record. Five-year return period rainfall events occurred in all phases of the study except the period immediately after logging in the South Fork, but were most frequent before road construction or logging occurred in either watershed.

The 10-day precipitation totals for the South Fork Caspar Creek station tell a similar story (*fig. 5*). Goodridge (1997) reported the 5-year return interval for this duration as 28.42 cm (11.19 in.). Storms in hydrologic years 1965, 1966, 1969, 1988, 1995, and 1998 exceeded this amount. The 1995 10-day total of 33.25 cm (13.09 in.) is second only to that of 1965, with 34.26 cm (13.49 in.), and

both of these exceed the 10-day, 10-year return interval storm of 32.56 cm (12.82 in.) reported by Goodridge (1997). Therefore, these longer-duration storms are distributed more evenly throughout the 36-year rainfall record than the 1-day storm events, and have occurred in all phases of the study except the period immediately after logging in the South Fork.

Durgin and others (1989) state that Caine's (1980) data are most relevant to harvest area related landslides, but a similar threshold may apply to road-related failures. Rice and others (1985) reported that Caine's 1-day threshold has about a 4-year return period on the North Coast of California. In Caspar Creek, Goodridge (1997) reported the 5-year 1-day storm as 11.07 cm (4.36 in.), which is slightly above Caine's 24-hour threshold of 10.4 cm (4.1 in.). Therefore, to determine whether forest practices are sufficient to prevent landsliding above background rates with Caine's threshold, it is necessary for logging units and new roads to be tested by a 4-year return interval storm event after seasonal precipitation amounts that produce saturated mantle conditions. Events of this magnitude occurred after logging impacts in the South Fork in water years 1969, 1985, and 1998, and in the North Fork in 1998.

Caine's index includes durations up to 10 days. Using his equation, minimum landslide-triggering rainfall amounts for 3-, 5-, and 10-day durations are 20.12 cm (7.92 in.), 27.50 cm (10.83 in.), and 41.95 cm (16.52 in.), respectively. These 3- and 5-day totals are between 10- and 25-year return interval events, and the 10-day total is between a 50- and 100-year event for Caspar Creek, based on Goodridge's (1997) data. Highest recorded totals for these durations at Caspar Creek are all less than Caine's thresholds.

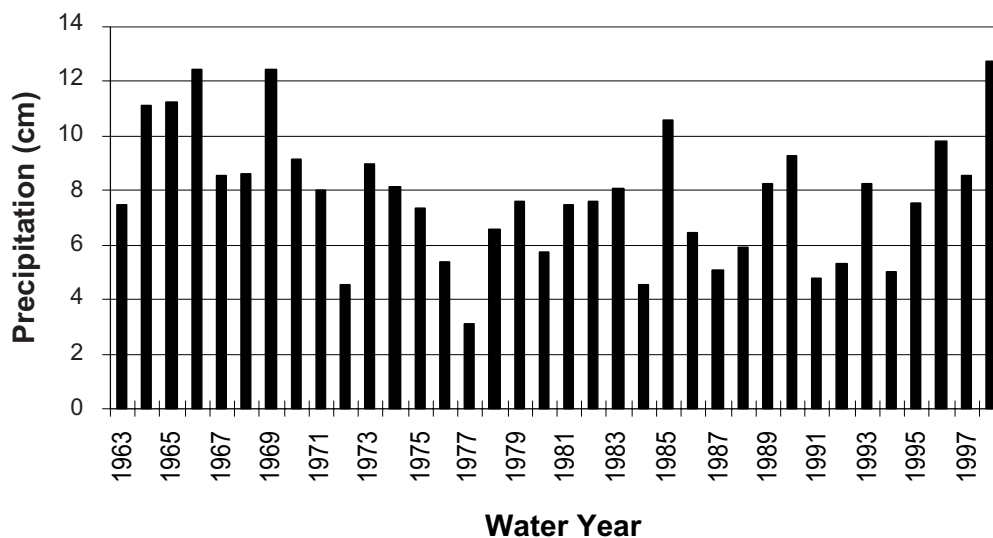

Figure 4—Annual maximum 1-day rainfall totals for the South Fork Caspar Creek 620 raingage.

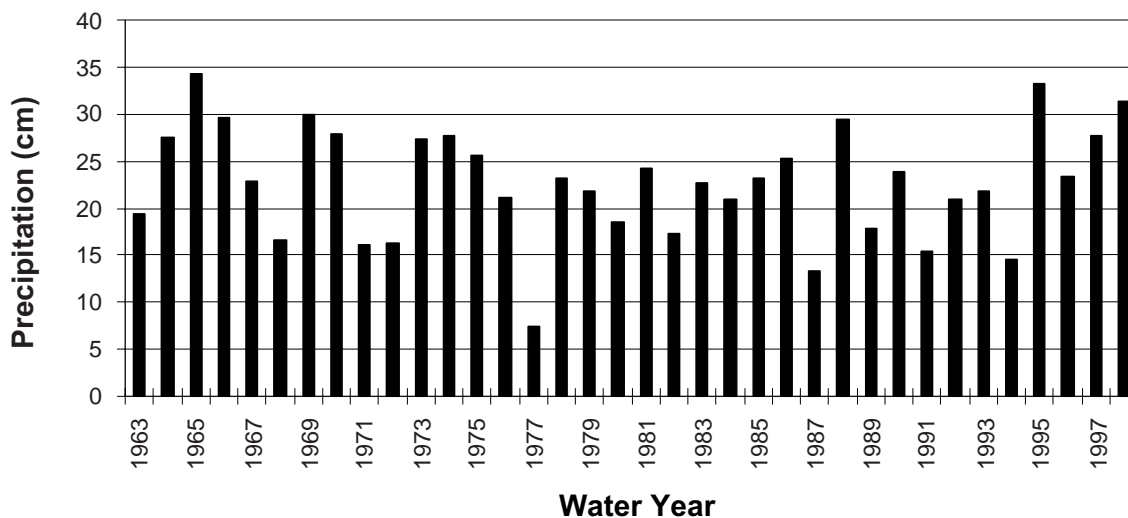

Figure 5—Annual maximum 10-day rainfall totals for the South Fork Caspar Creek 620 raingage.

Rainfall Records and Large Landslides in the North Fork

Eleven large (i.e., greater than or equal to 76.5 m³ or 100 yd³) landslides have been documented in the North Fork watershed during the life of the study⁸ (*table 1*). Five features are located in unharvested areas (i.e., mature second-growth forest), and six are in clearcut blocks. Three of these landslides were much larger than the others, exceeding 1,000 m³ (1,308 yd³). The first of these features occurred during March 1974 and was a shallow debris slide of approximately 3,306 m³ (4,324 yd³) that directly entered the North Fork of Caspar Creek (Rice and others 1979). The second recorded large feature was a shallow debris slide that occurred during February 1986, near the old splash dam site. Both of these landslides occurred before the most recent logging and were not associated with the clearcut logging or new road construction. The largest landslide in the study period was a 3,606-m³ (4,715-yd³) debris flow that came from a steep hollow high on a hillslope in a clearcut unit in January 1995.

The rainfall amounts for storm periods associated with the landslides larger than 76 m³ are displayed in *table 1*. The totals for 1-, 3-, 5-, and 10-day period preceding the event are generally similar for logged area and uncut area landslides. The mean precipitation totals for 1-, 3-, 5-, and 10-day durations are all below 5-year recurrence interval amounts. For individual storms, rainfall amounts for either 3-day or 10-day durations were at or over 2-year return intervals, whereas all but one of the 1-day totals were under this return frequency. This suggests that it is critical to have significant amounts of precipitation for long durations to generate

large landslides in Caspar Creek.

On the basis of the largest landslides documented in the North Fork during the life of the study, it appears that Caine's (1980) 1-day threshold of 10.4 cm (4.1 in.) is less important for slide initiation than 3-, 5-, or 10-day totals below Caine's thresholds. None of the recorded large landslides in the North Fork occurred when 1-day precipitation totals exceeded Caine's threshold, and all of the landslides occurred with precipitation totals that were less than Caine's thresholds for 3-, 5-, and 10-day totals.

Therefore, we defined a potential minimum threshold for stressing storm events on the basis of the rainfall amounts associated with known landslides in the North Fork. We screened the entire rainfall data set from August 1962 to April 1998 and determined the storm events that met minimum standards of 4.88 cm (1.92 in.) of precipitation in 1 day and either 11.94 cm (4.70 in.) in 3 days or 20.09 cm (7.91 in.) in 10 days. These rainfall amounts were based on the values triggering the landslides shown in *table 1*. Additionally, an antecedent precipitation index (API) was calculated for all daily rainfall totals in the life of the study.⁹ We found that 41 days and 34 unique storm sequences met the screening criteria (*fig. 6* and *appendix 1*). Three storm events occurred during the calibration period for both watersheds, five events took place after road construction in the South Fork, five events occurred during logging and recovery in the South Fork, six events occurred during the early 1980's before logging the North Fork, and 15 events occurred during the logging, road construction, and recovery period in the North Fork. These data suggest that storm events of magnitude similar to those known to have created landslides in the North Fork were reasonably well distributed over

⁸ The Critical Sites Erosion Study (Rice and Lewis 1991) used 189 m³ha⁻¹ (100 yd³ac⁻¹) as the definition of a large erosion site (either landslide or large gully). An inventory of erosion events greater than 7.6 m³ (10 yd³) was begun in 1986 for the North Fork.

⁹ API = Ppt_t + 0.9(API)_{t-1}

all phases of the study. The greatest number of storm events occurred during hydrologic year 1998.

Based on this interpretation of the landslide data and the rainfall record for the basin, we conclude that: (1) Caine's thresholds did not predict the conditions leading to landslides at Caspar Creek, (2) the approximate magnitude of stressing storms that have triggered failures in the North Fork watershed are equal to or greater than 4.88 cm (1.92 in.) of precipitation in 1 day and either 11.94 cm (4.70 in.) in 3 days or 20.09 cm (7.91 in.) in 10 days, (3) sufficient numbers of stressing rainstorms or combinations of storm events have tested the practices implemented on the landscape in both the South and North Fork, and (4) an extreme precipitation event, such as a 50-year return period storm of any duration, has not occurred in either watershed. When such an event occurs, we will be able to further evaluate the impacts of logging and road construction in Caspar Creek.

Streamflow Discharge Records

Streamflow has been measured at both the South Fork and North Fork weirs since hydrologic year 1963.¹⁰ Instantaneous annual peak discharges for the North Fork are displayed in *figure 7*. Peak discharges for 240 separate storm events were used for a partial duration flood series to plot a flood frequency analysis for both

watersheds (R. Ziemer, USFS-PSW, written communication).¹¹ Flood events with return periods of 5 or more years are shown in *table 2*. These data illustrate that for discharge, flood events with 5-year or greater return frequency occurred before and after logging for the South Fork phase, as well as before and after logging in the North Fork phase. The primary difference, however, is that the largest flood events for the South Fork phase had return frequencies of approximately 20 years, whereas the return frequencies for the North Fork phase were between 5 and 10 years.

Estimates of historic flooding can also be made for the Caspar Creek watershed. The December 1955 discharge measured at the USGS's Noyo River gaging station¹² was similar in size to that measured for the January 1993 storm. It is likely that this was also the case at Caspar Creek, because the distribution of major flood peaks is similar in both basins from 1963 to the present. This flood event was likely to have been about a 10-year return interval event at Caspar Creek. According to regional records, the only other large flood that is likely to have taken place in the 1900's may have occurred in 1937 (Janda and others 1975).

One possible reason why the return frequencies for rainfall and runoff differ relates to antecedent moisture conditions. If a watershed is fairly dry before a large precipitation event, considerably less runoff will occur when compared to a fully

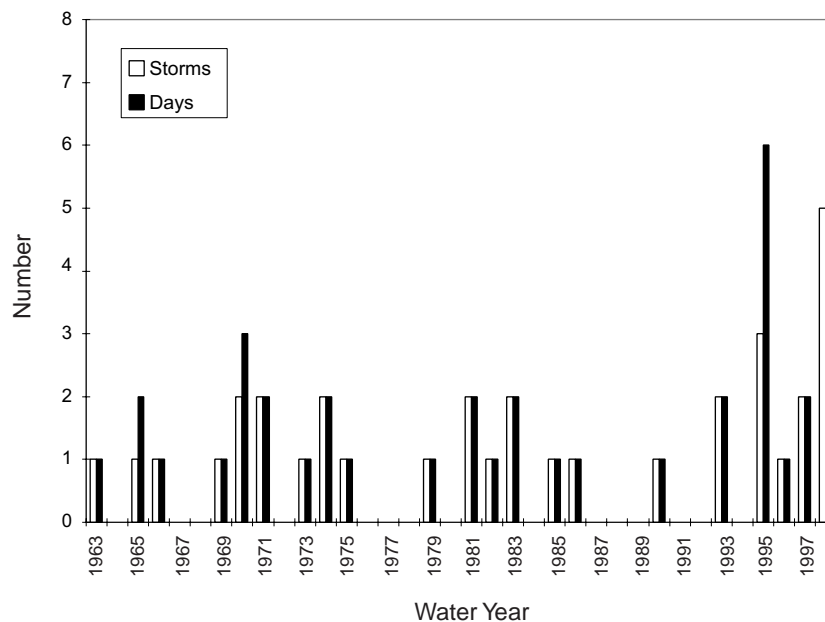

Figure 6—Number of days and unique storm sequences above the minimum threshold estimated to have the potential to produce landslides in the Caspar Creek watershed for the study period.

¹⁰ Data for hydrologic year 1977 is missing, but this was the driest year of record and no large peaks occurred that winter.

¹¹ A storm for this analysis was defined as having a stage of at least 0.6 m (2 ft) at the South Fork weir (or a discharge of $0.7 \text{ m}^3\text{s}^{-1}$ [$24.5 \text{ ft}^3\text{s}^{-1}$]).

¹² USGS No. 11468500; records at this station began in 1952. The station is located approximately 6.4 km (4 mi) to the north of the Caspar Creek watershed.

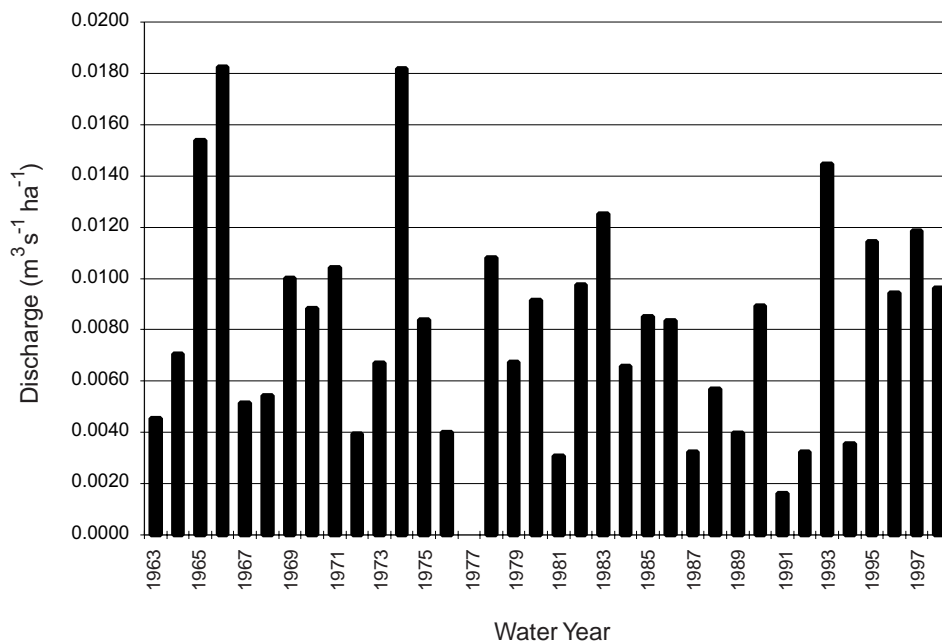

Figure 7—Maximum annual instantaneous peak discharges for the North Fork of Caspar Creek.

Table 2—North Fork Caspar Creek peak discharges with return intervals of 5 years or more.

Date	Discharge (m³ s⁻¹)	Discharge (m³ s⁻¹ ha⁻¹)	Discharge (ft³ s⁻¹)	Return Interval (yr)
01-04-1966	8.6	0.0182	304.9	21
01-16-1974	8.6	0.0182	304.3	21
03-29-1974	7.5	0.0159	263.8	12
12-21-1964	7.3	0.0154	257.5	10
01-20-1993	6.8	0.0145	241.6	8
12-21-1982	5.9	0.0125	209.6	6
12-09-1997	5.6	0.0118	198.0	5
03-14-1995	5.4	0.0115	191.5	5

saturated wet mantle condition. Antecedent wetness has been shown to be an important variable explaining runoff differences at Caspar Creek (Ziemer, these proceedings). Additionally, instantaneous peak discharges vary considerably depending on storm intensity and duration. Long-duration, low-intensity storm events can generate high rainfall amounts and high total storm flow volumes, but relatively low instantaneous peak discharges at Caspar Creek, when compared to shorter-duration storms with higher intensities.

Most sediment movement during an average hydrologic year occurs during a few, very large runoff events. Rice and others (1979) reported that about 80 percent of suspended sediment measured during the South Fork phase was transported by flows exceeding

1.13 m³ s⁻¹ (40 ft³ s⁻¹). Discharges of this magnitude occur about one percent of the time as shown by flow duration curves developed for both the North and South Forks of Caspar Creek.

Hillslope Erosion and Sediment Delivery Data

Hillslope erosion was measured for both the North and South Fork phases of the study. In the South Fork, estimates were obtained from seven plots distributed throughout the watershed. Plots were rectangular, approximately 200 m (656 ft) wide and 200 m to 320 m (1,050 ft) long. Gullies greater than 0.09 m² (1 ft²) in cross section and mass movements displacing more than 0.76 m³ (1 yd³) were

measured. Rice and others (1979) concluded that logging resulted in $81.1 \text{ m}^3 \text{ ha}^{-1}$ ($42.9 \text{ yd}^3 \text{ ac}^{-1}$) of hillslope erosion above background rates. Only 3 percent of the total erosion was rill erosion; the remainder occurred as landslides or large gullies (Rice and others 1979). Sheet erosion was not included in the erosion estimate.

Rice (1996) also completed a sediment delivery study in the North Fork of Caspar Creek. Comparable types of hillslope erosion measurements were made, but the sampling scheme differed considerably, with measurements made on smaller randomly located plots. Circular 0.08-ha (0.20-ac) plots were installed on harvested or forested areas, and road plots consisted of 1.5-m (5-ft) segments of road prism normal to the road centerline (plus erosion to the nearest drainage structure). Rice (1996) concluded that the average hillslope erosion rate above background levels for the North Fork was $45.5 \text{ m}^3 \text{ ha}^{-1}$ ($24.1 \text{ yd}^3 \text{ ac}^{-1}$), or roughly half that measured in the earlier South Fork study. We updated Rice's (1996) estimate with data through water year 1998 and revised Rice's earlier estimate to $47.6 \text{ m}^3 \text{ ha}^{-1}$ ($25.2 \text{ yd}^3 \text{ ac}^{-1}$).

These erosion rates are generally similar to those reported earlier in the literature. For example, Dodge and others (1976) found hillslope erosion rates on California's North Coast of 106, 77, 195, and $346 \text{ m}^3 \text{ ha}^{-1}$ (56, 41, 103, and $183 \text{ yd}^3 \text{ ac}^{-1}$) on slopes of 0-30, 31-50, 51-70, and > 70 percent, respectively, from timber harvesting conducted before the implementation of the modern forest practice rules. The Critical Sites Erosion Study (Rice and Lewis 1991) compared hillslope erosion on 0.81-ha (2-ac) sites having large erosion events greater than $189 \text{ m}^3 \text{ ha}^{-1}$ ($100 \text{ yd}^3 \text{ ac}^{-1}$) to randomly selected control sites and found an average of $19.1 \text{ m}^3 \text{ ha}^{-1}$ ($10.1 \text{ yd}^3 \text{ ac}^{-1}$) for roads and harvest areas with logging that was completed under the modern Forest Practice Rules (1978-1979). In the North Fork of Caspar Creek, using the landslides in the harvested units listed in *table 1*, we found that the comparable amount is $18.8 \text{ m}^3 \text{ ha}^{-1}$ ($10.0 \text{ yd}^3 \text{ ac}^{-1}$).

Rice and others (1979) reported that 22.4 percent of the measured hillslope erosion was delivered as sediment at the South Fork weir during the South Fork phase of the study. In contrast, for the North Fork logging, Rice (1996) calculated a sediment delivery of 11.3 percent at the North Fork weir. Therefore, Rice (1996) concluded that the North Fork logging resulted in approximately half as much erosion and a sediment delivery ratio that was similarly about half of the estimate for the South Fork logging. This indicates that the volume of sediment delivered to the stream channel in the North Fork was approximately one-quarter of that delivered to the South Fork.

Sediment Yields

Sediment sampling at Caspar Creek has been accomplished with several different techniques, reflecting changing technology and attempts to improve data quality. For most of the initial South Fork phase, suspended sediment yield was estimated with rising stage samplers mounted on the weirs. These devices, used from 1962 to 1975, are mounted at a specified stage and collect a sample only when the streamflow is rising. Some measurements were made with DH-48 depth-integrated hand-held samplers, but the majority of

the data was from the mounted bottles. In 1975, PS-69 automatic pumping samplers were installed at both the North and South Forks. During spring 1976, frequency-controlling devices were added to these pumping stations, which provided for more intensive sampling during higher flows. This, however, was at the very end of the South Fork phase and, for all practical purposes, did not heavily influence the study results. Suspended sediment yields collected during the South Fork phase were generated from sediment rating curves. Thomas (1990) reported that rating curve estimates of sediment yields are biased and depend systematically on sampling protocols.

Sediment measurement methods were substantially improved for the entire North Fork phase (1985-1995), which used SALT (Selection At List Time) sampling at both the North and South Fork weirs and also at 13 gaging stations located above the North Fork weir. This newer suspended sediment sampling technique yields unbiased estimates of sediment discharge. At Caspar Creek, the probability of taking a sample is based on stage height. This provides unbiased estimates of total suspended sediment yield while causing more sampling to occur at higher flows (Thomas 1985).

Bedload transport has been estimated with annual surveys of weir pond sedimentation. Sediment samples analyzed to determine the percentage of particles $\geq 2 \text{ mm}$ have been used to estimate the percentage of the material that settled behind the weirs and that can be considered bedload (material $\geq 1.4 \text{ mm}$), using a correction factor to account for the percentage of material from 1.4 mm to 2 mm (Napolitano 1996). Napolitano (1996) found that approximately 85 percent of the sediment produced at Caspar Creek can be considered suspended sediment. Material surveyed in the weir ponds averages about 35 percent of the total sediment load, which indicates that about 20 percent of the fine sediment ($< 1.4 \text{ mm}$) settles out in the ponds (Napolitano 1996). Lewis (these proceedings) has completed a similar data analysis and concluded that approximately 40 percent of the suspended sediment yield settles out in the weir ponds. With this analysis, approximately 30 percent of the total sediment yield can be considered bedload and 70 percent suspended sediment. This latter estimate is likely to be more accurate, since Napolitano (1996) used annual loads based on the fixed-stage samplers.

Annual sediment totals for suspended sediment and bedload measured at the weir ponds and estimated from samples taken at the weir outlets are shown in *figure 8* for both the North and South Forks of Caspar Creek. Mean sediment yields in the North and South Forks from 1963 to 1995 are $1,895$ and $2,018 \text{ kg ha}^{-1} \text{ yr}^{-1}$ (465 and $495 \text{ yd}^3 \text{ mi}^{-2} \text{ yr}^{-1}$), respectively.¹³

Lewis (these proceedings) has used a log-log model to compare suspended sediment and total sediment yields for both the North and South Forks for the before and after road construction and logging periods. For the South Fork, an increase of approximately 212 percent

¹³ Note that the sediment estimates made from 1963 to 1975 were made without SALT sampling and are likely to overestimate true suspended sediment loads, since rating curves were generally based on rising limb sediment collection.

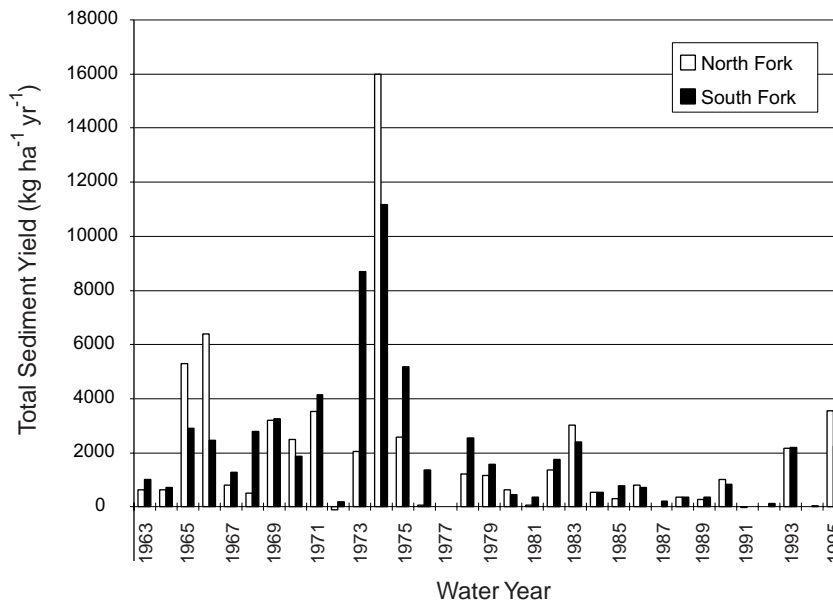

Figure 8—Total annual sediment yield for both the North and South Forks of Caspar Creek.

(2,510 kg ha⁻¹ yr⁻¹) over background levels has been calculated for suspended sediment loads for the first 6 years after the start of logging.¹⁴ Total sediment load was 184 percent (2,763 kg ha⁻¹ yr⁻¹) above expected levels. Lewis (these proceedings) has determined that because of the data collection techniques used for the South Fork phase, the original sediment volume estimate may be too high by a factor of 2 or 3 for suspended sediment measured in outflow from the weir, which would be approximately 1.7 to 2.4 times for the total volume of suspended sediment and bedload material. Sediment loads appeared to have returned to pre-logging levels in the 6th or 7th winter after the completion of logging (Thomas 1990). However, on the basis of widespread failures noted along South Fork roads during winter 1998, this conclusion may have been premature.

Lewis similarly calculated suspended sediment and total sediment yield increases above expected levels at the North Fork weir for logging and road construction during hydrologic years 1990 through 1995 and found no significant increase over background levels for either parameter. Lewis (these proceedings) then used a more sensitive analysis based on sediment measured at the North Fork weir for individual storm events compared to uncut tributaries upstream in the North Fork. This analysis indicated a significant, estimated increase of 89 percent (188 kg ha⁻¹ yr⁻¹) in suspended sediment over that predicted for undisturbed conditions.

Lewis (personal communication) has concluded that percent increase is a more accurate representation of increased sediment yields than sediment volume, because of the problems associated

with measurement techniques used in the South Fork phase of the study. Comparing the 89 percent increase for the North Fork with the 212 percent South Fork increase suggests that suspended sediment yields were 2.4 times greater following logging in the South Fork. This estimate is based on the unadjusted sediment measured in the North Fork during 1974, when a large landslide (see *table 1*) in the uncut basin produced more sediment than any of the post-disturbance years documented during the life of the study through water year 1995 (*fig. 8*).

Conclusions

After timber harvesting activities, both the North Fork and the South Fork of Caspar Creek were subjected to stressing storms that triggered landslide activity. The data indicate that high 3-day or 10-day precipitation totals in combination with moderately high 1-day amounts have been more important for initiating shallow landsliding than very high 1-day totals alone. Storm events with the potential to produce landslides, based on the minimum threshold we defined in this paper, have occurred at least 13 times since the completion of logging and road construction in the North Fork (*appendix 1*). Therefore, we conclude that stressing storm events with return intervals of up to 10 years have adequately tested the forestry practices implemented in the North Fork.

The frequency of landslides greater than 76 m³ (100 yd³) to date has not been substantially different between the clearcut units and the uncut control subwatersheds for the North Fork of Caspar Creek. Additionally, the volume of sediment discharged by landslides from the uncut and cut units to date has been

¹⁴ Data for hydrologic year 1977 is missing.

approximately the same: $21 \text{ m}^3 \text{ ha}^{-1}$ ($11 \text{ yd}^3 \text{ ac}^{-1}$) from the uncut units and $19 \text{ m}^3 \text{ ha}^{-1}$ ($10 \text{ yd}^3 \text{ ac}^{-1}$) from the harvested areas. Long-term monitoring will inform us if these trends continue with much larger stressing storm events. For perspective on the magnitude of past events, the largest landslide mapped in the North Fork watershed, the debris flow that dammed the creek for thousands of years, was on the order of 1,000,000 to 5,000,000 m^3 . This is more than three orders of magnitude larger than the largest landslide observed during the study.

Road, landing, and skid trail design, placement, and construction are the dominant controls on the number and locations of shallow landslides. As observed in the monitored part of the South Fork of Caspar Creek, land use practices, specifically tractor operations on steep slopes, can obscure and overwhelm intrinsic properties for shallow landslides. In contrast, in the watershed of the North Fork of Caspar Creek, where cable yarding was conducted on steeper slopes, the rate of landsliding is substantially lower, and there does not appear to be a significant increase in post-logging landsliding. Roads, landings, and skid trails that were constructed prior to the implementation of the Forest Practice Act have resulted in a legacy that continues to affect the watershed of the South Fork of Caspar Creek 30 years after operations began.

Results similar to those reported in this paper have been found elsewhere in northwestern California. Rice (1998) compared logging-related road erosion on industrial timberland in the middle portion of the Redwood Creek watershed before the implementation of the modern Forest Practice Rules with erosion rates associated with roads used in the 1990's. The estimated erosion rate under the modern Forest Practice Rules was about one-tenth of that estimated for an adjacent tributary of Redwood Creek as a result of timber operations utilized before 1976 (Best and others 1995).

Recommendations for Forest Managers Based on Caspar Creek Results

The lessons that have been learned at the Caspar Creek watershed may be applied to many North Coast watersheds. Numerous issues on Timber Harvesting Plans, such as hillslope erosion rates, sediment yields, and changes in peak flows, have already been addressed with data generated from this study.¹⁵ The value of having research-level, long-term monitoring data from various types of logging operations is significant in today's arena of listed species, Total Maximum Daily Load (TMDL) allocations, and Habitat Conservation Plans. The data provided by this project has, and will continue to be, used to estimate the true impacts of modern logging operations. Long-term monitoring should continue at Caspar Creek as further operations are completed in the basin in the future decades, and as the watersheds are subjected to large, long-return frequency storms and floods.

Clearly, forest managers in other North Coast watersheds

should take home the message that old roads built with practices prevalent in the 1950's, 1960's, and early to mid-1970's are still significant sources of erosion. Dr. William Weaver, Pacific Watershed Associates, has often referred to perched fill and poor watercourse crossings associated with old roads as "loaded guns" waiting to fail with strong stressing storm events. It is imperative that forest managers develop long-term *road management plans* that inventory these source areas and quickly reduce their numbers with an organized schedule based on watershed sensitivity and vulnerability of downstream beneficial uses.

One of the most important components of a comprehensive road management plan is the determination of which high-risk roads should be properly abandoned. Under the current California Forest Practice Rules, this means leaving a logging road in a condition that provides for long-term functioning of erosion controls with little or no continuing maintenance. Proper road abandonment usually involves removing watercourse crossing fills, removing unstable road and landing fills, and providing for erosion-resistant drainage (Weaver and Hagans 1994). During summer 1998, most of the old road system built in the South Fork watershed in 1967 will be properly abandoned. Proper abandonment of old roads and removal of high-risk sites on roads which will be part of the permanent transportation network are examples of the level of commitment from resource managers that is needed to substantially reduce the impacts from practices that were implemented on the landscape before the mid-1970's. Continued monitoring of the effects of various road abandonment techniques in Caspar Creek will aid forest managers elsewhere in developing proper abandonment practices.

References

- Best, D.W.; Kelsey, H.M.; Hagans, D.K.; Alpert, M. 1995. **Role of fluvial hillslope erosion and road construction in the sediment budget of Garrett Creek, Humboldt County, California.** In: Nolan, K.M.; Kelsey, H.M.; Marron, D.C., eds. Geomorphic processes and aquatic habitat in the Redwood Creek Basin, northwestern California. Professional Paper 1454. Washington, DC: U.S. Geological Survey; M1-M9.
- Caine, N. 1980. **The rainfall intensity-duration control of shallow landslides and debris flows.** *Geografiska Annaler* 62A(1-2): 23-27.
- Campbell, R.H. 1975. **Soil slips, debris flows, and rainstorms in the Santa Monica Mountains and vicinity, southern California.** Professional Paper 851. Menlo Park, CA: U.S. Geological Survey; 51 p.
- Cannon, S.H.; Ellen, S. 1985. **Abundant debris avalanches: San Francisco Bay Region, California.** *California Geology*, December, 1985: 267-272.
- Dodge, M.; Burcham, L.T.; Goldhaber, S.; McCulley, B.; Springer, C. 1976. **An investigation of soil characteristics and erosion rates on California forest lands.** Sacramento, CA: California Department of Forestry and Fire Protection; 105 p.
- Durgin, P.B.; Johnston, R.R.; Parsons, A.M. 1989. **Critical sites erosion study.** Vol 1: Causes of erosion on private timberlands in northern California: observations of the interdisciplinary team. A cooperative investigation by the California Department of Forestry and Fire Protection and USDA Forest Service. Sacramento, CA: California Department of Forestry and Fire Protection; 50 p.
- Goodridge, J. 1997. **California's rainfall records: 1862-1997.** CD ROM. CD produced by USDA Forest Service, Pacific Southwest Research Station, Arcata, California.
- Janda, R.J.; Nolan, K.M.; Harden, D.R.; Colman, S.M. 1975. **Watershed conditions in the drainage basin of Redwood Creek, Humboldt County, California, as of 1973.** Open-File Report 75-568. Menlo Park, CA: U.S. Geological Survey.

¹⁵ Permits issued by the California Department of Forestry and Fire Protection to log more than 1.2 ha (3 ac) on non-federal lands in California.

- Keppeler, E.T. Hydrologist, USDA Forest Service, Pacific Southwest Research Station, Fort Bragg, CA. [Conversation with Peter Cafferata]. 20 April 1998, Fort Bragg, California.
- Keppeler, E.T.; Ziemer, R.R.; Cafferata, P.H. 1994. **Changes in soil moisture and pore pressure after harvesting a forested hillslope in northern California.** In: Marston, R.A.; Hasfurther, V.R., eds. Effects of human-induced changes on hydrologic systems; 1994 June 26-29; Jackson Hole, WY. Herndon, VA: American Water Resources Association; 205-214.
- Kilbourne, R.T. 1982. **Geologic and geomorphic features related to landsliding, Glenblair NW 7.5' (NW 1/4 Comptche 15') quadrangle, Mendocino County, California.** Open-File Report OFR 82-25 SF, scale 1:24000. Sacramento, CA: California Division of Mines and Geology.
- Kilbourne, R.T. 1983. **Geologic and geomorphic features related to landsliding, Mendocino 7.5' quadrangle, Mendocino County, California.** Open-File Report OFR 83-15 SF, scale 1:24000. Sacramento, CA: California Division of Mines and Geology.
- Kilbourne, R.T.; Mata-Sol, A.R. 1983. **Geologic and geomorphic features related to landsliding, Glenblair SW 7.5' (SW 1/4 Comptche 15') quadrangle, Mendocino County, California.** Open-File Report OFR 83-20 SF, scale 1:24000. Sacramento, CA: California Division of Mines and Geology.
- LaHusen, R.G. 1984. **Characteristics of management-related debris flows, northwestern California.** In: O'Loughlin, C.L.; Pearce, A.J., eds. Symposium on effects of forest land use on erosion and slope stability; 7-11 May 1984; Honolulu, Hawaii. International Union of Forestry Research Organizations; 139-145.
- Lewis, J., Mathematical Statistician, USDA Forest Service, Pacific Southwest Research Station, Arcata, California [Telephone conversation with Peter Cafferata]. 7 April 1998.
- Napolitano, M.B. 1996. **Sediment transport and storage in North Fork Caspar Creek, Mendocino County, California: water years 1980-1988.** Arcata, CA: Humboldt State University; 148 p. M.S. thesis.
- Reneau, S. [Letter to Thomas Spittler]. 19 December 1989. Sent from Los Alamos National Laboratory, Los Alamos, New Mexico. Letter located at California Division of Mines and Geology, 135 Ridgway, Santa Rosa, CA.
- Rice, R.M. 1996. **Sediment delivery in the North Fork of Caspar Creek.** Draft final report submitted to the California Department of Forestry and Fire Protection., Sacramento, CA. Coop. Agreement No. 9CA94077. 13 p.
- Rice, R.M. 1998. **Erosion on logging roads in Redwood Creek, Northwestern California.** Arcata, CA. Unpublished draft supplied by author; 23 p.
- Rice, R.M.; Lewis, J. 1991. **Estimating erosion risks associated with logging and forest roads in northwestern California.** Water Resources Bulletin 27(5): 809-818.
- Rice, R.M.; Tilley, F.B.; Datzman, P.A. 1979. **A watershed's response to logging and roads: South Fork of Caspar Creek, California, 1967-1976.** Res. Paper PSW-146. Berkeley, CA: Pacific Southwest Forest and Range Experiment Station, Forest Service, U.S. Department of Agriculture; 12 p.
- Rice, R.M.; Pillsbury, N.H.; Schmidt, K.W. 1985. **A risk analysis approach for using discriminant functions to manage logging-related landslides on granitic terrain.** Forest Science 31(3): 772-784.
- Sidle, R.C.; Pearce, A.J.; O'Loughlin, C.L. 1985. **Hillslope stability and land use.** Washington, DC: American Geophysical Union; 55-56.
- Spittler, T.E.; McKittrick, M.A. 1995. **Geologic and geomorphic features related to landsliding, North and South Forks of Caspar Creek, Mendocino County, California.** Open-File Report 95-08, scale 1:12,000. Sacramento, CA: California Division of Mines and Geology.
- Thomas, R.B. 1985. **Estimating total suspended sediment yield with probability sampling.** Water Resources Research 21(9): 1381-1388.
- Thomas, R.B. 1990. **Problems in determining the return of a watershed to pretreatment conditions: techniques applied to a study at Caspar Creek, California.** Water Resources Research 26(9): 2079-2087.
- Weaver, W.M.; Hagans, D.K. 1994. **Handbook for forest and ranch roads: a guide for planning, designing, constructing, reconstructing, maintaining, and closing wildland roads.** Ukiah, CA: Mendocino County Resource Conservation District; 161 p.
- Wieczorek, G.F.; Sarmiento, J. 1983. **Significance of storm intensity-duration for triggering of debris flows near La Honda, California.** Geological Society of America Abstracts with Programs 15(5): 289.
- Wurm, T. 1986. **Mallets on the Mendocino Coast.** Glendale, CA: Trans-Anglo Books; 134 p.
- Ziemer, R.R. [facsimile sent to Peter Cafferata]. 20 March 1998. 11 pages. Located at California Department of Forestry and Fire Protection, Sacramento, CA.

Appendix 1—Dates and amounts of precipitation (cm) above the defined threshold based on actual landslides and associated Antecedent Precipitation Index (API) levels for the entire study period. Abbreviations under Study Period are South Fork (SF), North Fork (NF), and Subwatershed YZ (YZ).

Date	Study Period	Hydrologic Yr	1-day	3-day	10-day	API
10-11-62	Calibration	1963	7.49	12.80	14.38	13.36
12-21-64	Calibration	1965	11.28	17.78	19.58	20.09
12-22-64	Calibration	1965	5.41	18.06	24.99	23.50
01-04-66	Calibration	1966	11.89	18.39	26.97	23.29
01-11-69	Post SF road	1969	12.42	12.65	12.78	16.38
12-12-69	Post SF road	1970	9.14	13.97	15.88	14.76
01-23-70	Post SF road	1970	6.10	13.72	27.79	24.36
01-26-70	Post SF road	1970	5.08	6.40	27.84	23.93
12-03-70	Post SF road	1971	7.29	11.68	22.94	17.70
01-16-71	Post SF road	1971	5.84	13.77	20.90	19.02
01-11-73	Logging SF	1973	8.97	14.66	17.60	17.40
01-15-74	Post SF log, road	1974	6.10	15.11	16.43	17.45
03-31-74	Post SF log, road	1974	6.17	11.79	20.09	17.30
03-21-75	Post SF log, road	1975	7.11	7.37	20.75	18.64
02-13-79	Post SF log, road	1979	5.72	12.22	13.23	13.08
12-03-80	Pre NF log, road	1981	7.52	13.23	14.63	14.35
01-27-81	Pre NF log, road	1981	6.73	8.64	20.98	16.18
02-15-82	Pre NF log, road	1982	7.62	14.48	14.48	14.61
12-21-82	Pre NF log, road	1983	8.00	10.92	20.14	17.93
01-26-83	Pre NF log, road	1983	8.08	12.14	23.44	18.47
11-11-84	Pre NF log, road	1985	10.62	14.81	18.77	18.97
02-16-86	Log, road NF (YZ)	1986	4.95	11.94	16.13	16.92
05-27-90	Log, road main NF	1990	4.88	12.40	23.77	17.81
12-31-92	Post NF log, road	1993	8.28	16.74	12.65	17.42
01-20-93	Post NF log, road	1993	6.05	10.90	20.98	20.17
01-08-95	Post NF log, road	1995	7.54	12.42	17.86	16.48
01-09-95	Post NF log, road	1995	5.97	15.62	23.67	20.80
01-13-95	Post NF log, road	1995	6.40	11.35	33.25	25.17
03-13-95	Post NF log, road	1995	5.44	8.10	20.47	16.61
03-14-95	Post NF log, road	1995	5.11	11.38	25.58	20.07
03-20-95	Post NF log, road	1995	5.23	7.54	21.11	18.08
01-24-96	Post NF log, road	1996	5.13	7.42	23.37	16.56
12-09-96	Post NF log, road	1997	8.31	12.52	25.12	20.60
12-31-96	Post NF log, road	1997	8.59	17.60	23.90	23.55
11-26-97	Post NF log, road	1998	12.75	13.54	19.02	19.15
01-12-98	Post NF log, road	1998	5.00	11.94	17.48	15.65
01-14-98	Post NF log, road	1998	5.00	11.56	20.17	19.08
01-18-98	Post NF log, road	1998	5.00	9.68	30.43	22.96
01-26-98	Post NF log, road	1998	7.67	11.15	21.26	22.40
02-21-98	Post NF log, road	1998	4.98	11.73	22.83	22.89
03-22-98	Post NF log, road	1998	5.08	12.57	12.62	15.16

Cumulative Watershed Effects: Caspar Creek and Beyond¹

Leslie M. Reid²

Abstract: Cumulative effects are the combined effects of multiple activities, and watershed effects are those which involve processes of water transport. Almost all impacts are influenced by multiple activities, so almost all impacts must be evaluated as cumulative impacts rather than as individual impacts. Existing definitions suggest that to be significant, an impact must be reasonably expected to have occurred or to occur in the future, and it must be of societally validated concern to someone or influence their activities or options. Past approaches to evaluating and managing cumulative watershed impacts have not yet proved successful for averting these impacts, so interest has grown in how to regulate land-use activities to reverse existing impacts. Approaches being discussed include requirements for “zero net increase” of sediment, linkage of planned activities to mitigation of existing problems, use of more protective best management practices, and adoption of thresholds for either land-use intensity or impact level. Different kinds of cumulative impacts require different kinds of approaches for management. Efforts are underway to determine how best to evaluate the potential for cumulative impacts, and thus to provide a tool for preventing future impacts and for determining which management approaches are appropriate for each issue in an area. Future impact analysis methods probably will be based on strategies for watershed analysis. Analysis would need to consider areas large enough for the most important impacts to be evident; to evaluate time scales long enough for the potential for impact accumulation to be identified; and to be interdisciplinary enough that interactions among diverse impact mechanisms can be understood.

Ten years ago, cumulative impacts were a major focus of controversy and discussion. Today they still are, although the term “effects” has generally replaced “impacts,” in part to acknowledge the fact that not all cumulative changes are undesirable. However, because the changes most relevant to the issue are the undesirable ones, “cumulative effect” is usually further modified to “adverse cumulative effect.”

The good news from the past 10 years’ record is that it was not just the name that changed. Most of the topics of discourse have also shifted (table 1), and this shift in focus is evidence of some

progress in understanding. The bad news is that progress was too little to have prevented the cumulative impacts that occurred over the past 10 years. This paper first reviews the questions that have been resolved in order to provide a historical context for the problem, then uses examples from Caspar Creek and New Zealand to examine the issues surrounding questions yet to be answered.

Then: What Is a Cumulative Impact?

The definition of cumulative impacts should have been a trivial problem because a legal definition already existed. According to the Council on Environmental Quality (CEQ Guidelines, 40 CFR 1508.7, issued 23 April 1971),

“Cumulative impact” is the impact on the environment which results from the incremental impact of the action when added to other past, present, and reasonably foreseeable future actions regardless of what agency (Federal or non-Federal) or person undertakes such other actions. Cumulative impacts can result from individually minor but collectively significant actions taking place over a period of time.

This definition presented a problem, though. It seemed to include everything, and a definition of a subcategory is not particularly useful if it includes everything. A lot of effort thus went into trying to identify impacts that were modified because of interactions with other impacts. In particular, the search was on for “synergistic impacts,” in which the impact from a combination of activities is greater than the sum of the impacts of the activities acting alone.

In the long run, though, the legal definition held: “cumulative impacts” are generally accepted to include all impacts that are influenced by multiple activities or causes. In essence, the definition did not define a new type of impact. Instead, it expanded the context in which the significance of any impact must be evaluated. Before,

Table 1—Commonly asked questions concerning cumulative impacts in 1988 (then) and 1998 (now).

Then:	Now:
What is a cumulative impact?	What is a “significant” adverse cumulative effect?
Do cumulative impacts exist?	How can regulation reverse adverse cumulative effects?
How can cumulative impacts be avoided?	How can adverse cumulative effects be avoided?

¹ An abbreviated version of this paper was presented at the Conference on Coastal Watersheds: The Caspar Creek Story, May 6, 1998, Ukiah, California.

² Research Geologist, USDA Forest Service Pacific Southwest Research Station, Redwood Sciences Laboratory, 1700 Bayview Dr., Arcata, CA 95521

regulations could be written to allow an activity to occur as long as the impacting party took the best economically feasible measures to reduce impacts. If the portion of the impact attributable to a particular activity was not independently damaging, that activity was not accountable. Now, however, the best economically feasible measures are no longer sufficient if the impact still occurs. The activities that together produce the impact are responsible for that impact, even if each activity is individually responsible for only a small portion of the impact.

A cumulative watershed impact is a cumulative impact that influences or is influenced by the flow of water through a watershed. Most impacts that occur away from the site of the triggering land-use activity are cumulative watershed impacts, because something must be transported from the activity site to the impact site if the impact is to occur, and water is one of the most common transport media. Changes in the water-related transport of sediment, woody debris, chemicals, heat, flora, or fauna can result in off-site cumulative watershed impacts.

Then: Do Cumulative Impacts Actually Occur?

The fact that the CEQ definition of cumulative impacts prevailed made the second question trivial: almost all impacts are the product of multiple influences and activities and are, therefore, cumulative impacts. The answer is a resounding “yes.”

Then: How Can Cumulative Impacts Be Avoided?

Because the National Environmental Policy Act of 1969 specified that cumulative effects must be considered in evaluations of environmental impact for federal projects and permits, methods for regulating cumulative effects had to be established even before those effects were well understood. Similar legislation soon followed in some states, and private landowners and state regulatory agencies also found themselves in need of approaches for addressing cumulative impacts. As a result, a rich variety of methods to evaluate and regulate cumulative effects was developed. The three primary strategies were the use of mechanistic models, indices of activity levels, and analysis.

Mechanistic models were developed for settings where concern focused on a particular kind of impact. On National Forests in central Idaho, for example, downstream impacts of logging on salmonids were assumed to arise primarily because of deposition of fine sediments in stream gravels. Abundant data allowed relationships to be identified between logging-related activities and sedimentation (Cline and others 1981) and between sedimentation and salmonid response (Stowell and others 1983). Logging was then distributed to maintain low sedimentation rates. Unfortunately, this approach does not address the other kinds of impacts that might occur, and it relies heavily on a good understanding of the locale-specific relationships between activity and impact. It cannot be applied to other areas in the absence of lengthy monitoring programs.

National Forests in California initially used a mechanistic model that related road area to altered peak flows, but the model was soon found to be based on invalid assumptions. At that point, “equivalent road acres” (ERAs) began to be used simply as an index of management intensity instead of as a mechanistic driving variable. All logging-related activities were assigned values according to their estimated level of impact relative to that of a road, and these values were summed for a watershed (USDA Forest Service 1988). Further activities were deferred if the sum was over the threshold considered acceptable. Three problems are evident with this method: the method has not been formally tested, different kinds of impacts would have different thresholds, and recovery is evaluated according to the rate of recovery of the assumed driving variables (e.g., forest cover) rather than to that of the impact (e.g., channel aggradation). Cumulative impacts thus can occur even when the index is maintained at an “acceptable” value (Reid 1993).

The third approach, locale-specific analysis, was the method adopted by the California Department of Forestry for use on state and private lands (CDF 1998). This approach is potentially capable of addressing the full range of cumulative impacts that might be important in an area. A standardized impact evaluation procedure could not be developed because of the wide variety of issues that might need to be assessed, so analysis methods were left to the professional judgment of those preparing timber harvest plans. Unfortunately, oversight turned out to be a problem. Plans were approved even though they included cumulative impact analyses that were clearly in error. In one case, for example, the report stated that the planned logging would indeed introduce sediment to streams, but that downstream riparian vegetation would filter out all the sediment before it did any damage. Were this actually true, virtually no stream would carry suspended sediment. In any case, even though timber harvest plans prepared for private lands in California since 1985 contain statements attesting that the plans will not result in increased levels of significant cumulative impacts, obvious cumulative impacts have accrued from carrying out those plans. Bear Creek in northwest California, for example, sustained 2 to 3 meters of aggradation after the 1996-1997 storms, and 85 percent of the sediment originated from the 37 percent of the watershed area that had been logged on privately owned land during the previous 15 years (Pacific Watershed Associates 1998).

EPA’s recent listing of 20 north coast rivers as “impaired waterways” because of excessive sediment loads, altered temperature regimes, or other pervasive impacts suggests that whatever the methods used to prevent and reverse cumulative impacts on public and private lands in northwest California, they have not been successful. At this point, then, we have a better understanding of what cumulative impacts are and how they are expressed, but we as yet have no workable approach for avoiding or managing them.

The Interim: Examples

One of the reasons that the topics of discourse have changed over the past 10 years is that a wider range of examples has been studied. As more is learned about how particular cumulative impacts

develop and are expressed, it becomes more possible to predict and manage future impacts. Two examples serve here to display complementary approaches to the study of cumulative impacts and to provide a context for discussion of the remaining questions.

Studying Cumulative Impacts at Caspar Creek

Cumulative impacts result from the accumulation of multiple individual changes. One approach to the study of cumulative impacts, therefore, is to study the variety of changes caused by a land-use activity in an area and evaluate how those changes interact. This approach is essential for developing an understanding of the changes that can generate cumulative impacts, and thus for understanding the potential mechanisms of impact. The long-term, detailed hydrological studies carried out before and after selective logging of a second-growth redwood forest in the 4-km² South Fork Caspar Creek watershed and clearcut logging in 5-km² North Fork Caspar Creek watershed provide the kinds of information needed for this approach. Other papers in these proceedings describe the variety of studies carried out in the area, and here the results of those studies are reviewed as they relate to cumulative impacts.

Results of the South Fork study suggest that 65-percent selective logging, tractor yarding, and associated road management more than doubled the sediment yield from the catchment (Lewis, these proceedings), while peak flows showed a statistically significant increase only for small storms near the beginning of the storm season (Ziemer, these proceedings). Sediment effects had returned to background levels within 8 years of the end of logging, while minor hydrologic effects persisted for at least 12 years (Thomas 1990). Road construction and logging within riparian zones has helped to perpetuate low levels of woody debris loading in the South Fork that originally resulted from the first cycle of logging and from later clearing of in-stream debris. An initial pulse of blowdown is likely to have occurred soon after the second-cycle logging, but the resulting woody debris is now decaying. Today's near-channel stands contain a high proportion of young trees and alders, so debris loadings are likely to continue to decrease in the future until riparian stands are old enough to contribute wood. Results of the South Fork study reflect roading, logging, and yarding methods used before forest practice rules were implemented.

Local cumulative impacts from two cycles of logging along the South Fork are expressed primarily in the altered channel form caused by loss of woody debris and the presence of a main haul road adjacent to the channel. But for the presence of the South Fork weir pond, which trapped most of the sediment load, downstream cumulative impacts could have resulted from the increased sediment load in combination with similar increases from surrounding catchments. Although the initial increase in sediment load had recovered in 8 years, estimates of the time over which sediment impacts could accumulate downstream of analogous watersheds without weirs would require information about the residence time of sediment at sites of concern downstream. Recent observations suggest that the 25-year-old logging is now contributing a second pulse of sediment as abandoned roads begin to fail (Cafferata and Spittler, these proceedings), so the overall

impact of logging in the South Fork may prove to be greater than previously thought.

The North Fork studies focus on the effects of clearcut logging, largely in the absence of near-stream roads. The primary study was designed to test for the presence of synergistic cumulative impacts on suspended sediment load and storm flows. Nested watersheds were monitored before and after logging to determine whether the magnitude of hydrologic and sediment transport changes increased, decreased, or remained constant downstream. Results showed that the short-term effects on sediment load and runoff increased approximately in proportion to the area logged above each gauging station, thus suggesting that the effect is additive for the range of storms sampled. Long-term effects continue to be studied.

Results also show an 89 percent increase in sediment load after logging of 50 percent of the watershed (Lewis, these proceedings). Peak flows greater than 4 L s⁻¹ ha⁻¹, which on average occur less than twice a year, increased by 35 percent in completely clearcut tributary watersheds, although there was no statistically significant change in peak flow at the downstream-most gauging station (Ziemer, these proceedings). Observations in the North Fork watershed suggest that much of the increased sediment may come from stream-bank erosion, headward extension of unbuffered low-order streams, and accelerated wind-throw along buffered streams (Lewis, these proceedings). Channel disruption is likely to be caused, in part, by increased storm-flow volumes. Increased sediment appeared at the North Fork weir as suspended load, while bedload transport rates did not change significantly. It is likely that the influx of new woody debris caused by accelerated blow-down near clearcut margins provided storage opportunities for increased inputs of coarse sediment (Lisle and Napolitano, these proceedings), thereby offsetting the potential for downstream cumulative impacts associated with coarse sediment. However, accelerated blow-down immediately after logging and selective cutting of buffer strips may have partially depleted the source material for future woody debris inputs (Reid and Hilton, these proceedings). Bedload sediment yields may increase if future rates of debris-dam decay and failure become higher than future rates of debris infall.

But the North Fork of Caspar Creek drains a relatively small watershed. It is one-tenth the size of Freshwater Creek watershed; one-hundredth the size of Redwood Creek watershed; one-thousandth the size of the Trinity River watershed. In these three cases, the cumulative impacts of most concern occurred on the main-stem channels; impacts were not identified as a major issue on channels the size of Caspar Creek. Thus, though studies on the scale of those carried out at Caspar Creek are critical for identifying and understanding the mechanisms by which impacts are generated, they can rarely be used to explore how the impacts of most concern are expressed because these watersheds are too small to include the sites where those impacts occur. Far downstream from a watershed the size of Caspar Creek, doubling of suspended sediment loads might prove to be a severe impact on water supplies, reservoir longevity, or estuary biota.

In addition, the 36-year-long record from Caspar Creek is short relative to the time over which many impacts are expressed. The in-

channel impacts resulting from modification of riparian forest stands will not be evident until residual wood has decayed and the remaining riparian stands have regrown and equilibrated with the riparian management regime. Establishment of the eventual impact level may thus require several hundred years.

Studying Cumulative Impacts in the Waipaoa Watershed

A second approach to cumulative impact research is to work backwards from an impact that has already occurred to determine what happened and why. This approach requires very different research methods than those used at Caspar Creek because the large spatial scales at which cumulative impacts become important prevent acquisition of detailed information from throughout the area. In addition, time scales over which impacts have occurred are often very long, so an understanding of existing impacts must be based on after-the-fact detective work rather than on real-time monitoring. A short-term study carried out in the 2205-km² Waipaoa River catchment in New Zealand provides an example of a large-scale approach to the study of cumulative impacts.

A central focus of the Waipaoa study was to identify the long-term effects of altered forest cover in a setting with similar rock type, tectonic activity, topography, original vegetation type, and climate as northwest California (*table 2*). The major difference between the two areas is that forest was converted to pasture in New Zealand, while in California the forests are periodically regrown. The strategy used for the study was similar to that of pharmaceutical experiments: to identify possible effects of low dosages, administer high doses and observe the extreme effects. Results, of course, may

depend on the intensity of the activity and so may not be directly transferable. However, results from such a study do give a very good idea of the kinds of changes that might happen, thus defining early-warning signs to be alert for in less-intensively altered systems.

The impact of concern in the Waipaoa case was flooding; residents of downstream towns were tired of being flooded, and they wanted to know how to decrease the flood hazard through watershed restoration. The activities that triggered the impacts occurred a century ago. Between 1870 and 1900, beech-podocarp forests were converted to pasture by burning, and gullies and landslides began to form on the pastures within a few years. Sediment eroded from these sources began accumulating in downstream channels, eventually decreasing channel capacity enough that sheep farms in the valley began to flood with every moderate storm. Most of the farms had been moved to higher ground by about 1920. Today, the terraces they originally occupied are themselves at the level of the channel bed, and 30 m of aggradation have been documented at one site (Allsop 1973). By the mid-1930's, aggradation had reached the Whatatutu town-site 20 km downstream, forcing the entire town to be moved onto a terrace 60 m above its original location.

Meanwhile, levees were being constructed farther downstream, and high-value infrastructure and land-use activities began to accumulate on the newly "protected" lowlands. At about the same time as levees were constructed, the frequency of severe flooding, as identified from descriptions in the local newspaper, increased. Climatic records show no synchronous change in rainfall patterns.

The hydrologic and geomorphic changes that brought about the Waipaoa's problems are of the same kinds measured 10,000 km

Table 2—Comparison of settings for the South Fork Eel River Basin and the Waipaoa River Basin.

Characteristic	South Fork Eel River Basin ¹	Waipaoa River Basin
Area (km ²)	1,760	2,205
Latitude	39°30'N to 40°20'N	38°10'S to 38°50'S
Bedrock	Intensely sheared late Mesozoic sediments and volcanics; Tertiary sedimentary rocks	Intensely sheared late Mesozoic sediments and volcanics; Tertiary sedimentary rocks
Rainfall (mm/yr)	1,500 to 2,900	900 to 3,000
Maximum elevation (m)	1,290	970
Uplift rate (mm/yr)	0 to 4	0 to 3
Sediment yield (t km ⁻² yr ⁻¹)	5,000	7,500
Original vegetation	Redwood, Douglas-fir, hardwood, grassland	Podocarp conifers, southern beech hardwoods, bracken scrub
Current vegetation	Redwood, Douglas-fir, hardwood, grassland	Grassland; some reforestation of Monterey pines
Current land use	Logging, ranching	Sheep farming

¹Information primarily from Scott and Buer (1983)

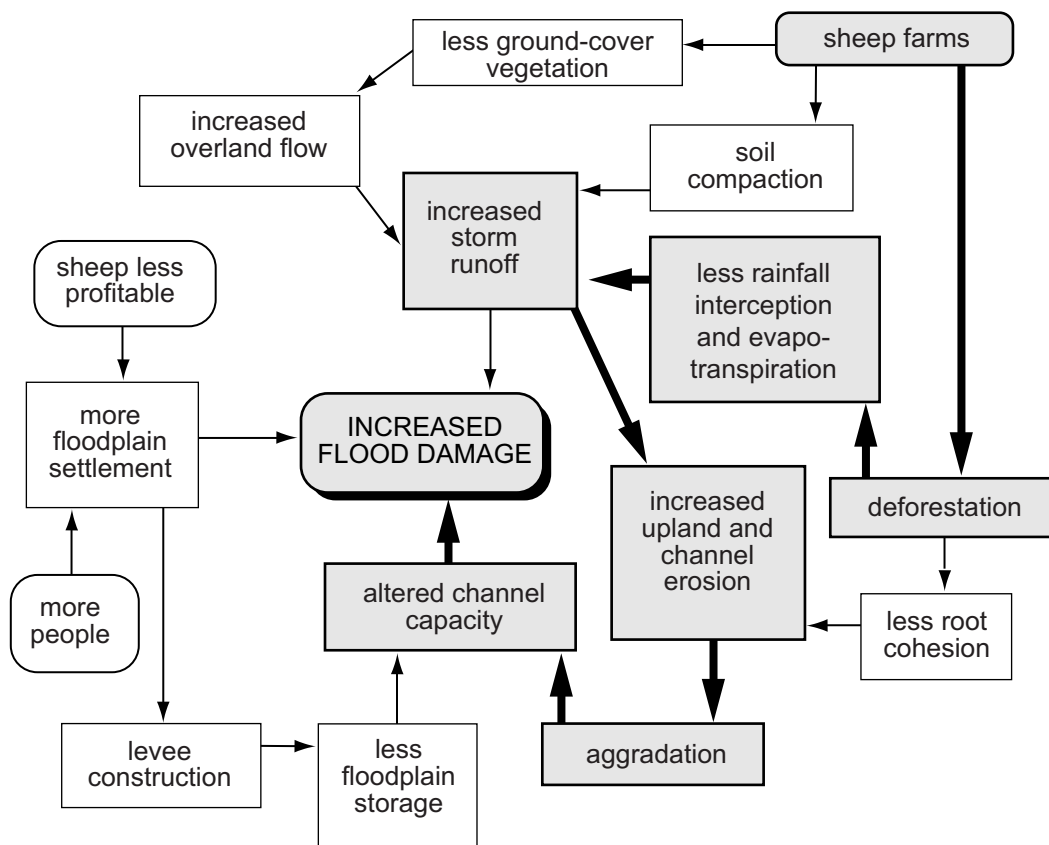

Figure 1—Factors influencing changes in flood hazard in the Waipaoa River basin, North Island, New Zealand. Bold lines and shaded boxes indicate the likely primary mechanism of influence.

away in Caspar Creek: runoff and erosion rates increased with the removal of the forest cover. However, the primary reason for increased flood frequencies was not the direct effects of hydrologic change, but the indirect effects (fig. 1). Had peak-flow increases due to altered evapotranspiration and interception loss after deforestation been the primary cause of flooding, increased downstream flood frequencies would have dated from the 1880's, not from the 1910's. The presence of gullies in forested land downslope of grasslands instead suggests that the major impact of locally increased peak-flows was the destabilization of low-order channels, which then led to downstream channel aggradation, decreased channel capacity, and flooding. At the same time, loss of root cohesion contributed to hillslope destabilization and further accelerated aggradation. The levees themselves probably aggravated the impact nearby by reducing the volume of flood flow that could be temporarily stored, and the significance of the impact was increased by the increased presence of vulnerable infrastructure.

The impacts experienced in the Waipaoa catchment demonstrate a variety of cumulative effects. First, deforestation occurred over a wide-enough area that enough sediment could accumulate to cause a problem. Second, deforestation persisted, allowing impacts to accumulate through time. Third, the sediment

derived from gully erosion (caused primarily by increased local peak flows) combined with lesser amounts contributed by landslides (triggered primarily by decreased root cohesion). Fourth, flood damage was increased by the combined effects of decreased channel capacity, increased runoff, the presence of ill-placed levees, and the increased presence of structures that could be damaged by flooding (fig. 1).

The Waipaoa example also illustrates the time-lags inherent in the expression of impacts over large areas. Deforestation began in the 1870's, but the first serious impacts were not experienced until about 1900. Although deforestation had approached its maximum extent by 1920, impacts were still accumulating; Whatatutu was not relocated until 15 years later. A large portion of the most severely affected area began to be reforested by 1970, yet downstream aggradation continues a quarter of a century later. Once the hillslope conditions had been altered enough to initiate the chain of impact mechanisms, some level of impact was inevitable.

But how much of the Waipaoa story can be used to understand impacts in California? In California, although road-related effects persist throughout the cutting cycle, hillslopes experience the effects of deforestation only for a short time during each cycle, so only a portion of the land surface is vulnerable to excessive damage from

large storms at any given time (Ziemer and others 1991). Average erosion and runoff rates are increased, but not by as much as in the Waipaoa watershed; and partial recovery is possible between impact cycles. If, as expected, similar trends of change (e.g., increased erosion and runoff) predispose similar landscapes to similar trends of response, then the Waipaoa watershed provides an indication of the kinds of responses that northwest California watersheds might more gradually undergo. The first response: increased landsliding and gullying. The second: pervasive channel aggradation. Both kinds of responses are already evident at sites in northwest California where the rate of temporary deforestation has been particularly high (Madej and Ozaki 1996, Pacific Watershed Associates 1998), suggesting that response mechanisms similar to those of the Waipaoa are underway. However, it is not yet known what the eventual magnitude of the responses might be.

Now: What Is a “Significant” Adverse Cumulative Effect?

The key to the definition now lies in the word “significant,” and “significant” is one of those words that has a different definition for every person who uses it. Two general categories of definition are particularly meaningful in this context, however. To a scientist, a “significant” change is one that can be demonstrated with a specified level of certainty. For example, if data show that there is only a probability of 0.13 that a measured 1 percent increase in sediment load would appear by chance, then that change is statistically significant at the 87 percent confidence level, irrespective of whether a 1 percent change makes a difference to anything that anyone cares about.

The second category of definition concentrates on the nature of the interaction: if someone cares about a change or if the change affects their activities or options, it is “significant” or “meaningful” to them. This definition does not require that the change be definable statistically. An unprecedented activity might be expected on the basis of inference to cause significant changes even before actual changes are statistically demonstrable. Or to put it another way, if cause-and-effect relationships are correctly understood, one does not necessarily have to wait for an experiment to be performed to know what the results are likely to be and to plan accordingly.

In the context of cumulative effects, elements of both facets of the definition are obviously important. According to the Guidelines for Implementation of the California Environmental Quality Act (14 CCR 15064, filed 13 July 1983, amended 27 May 1997),

- (g) *The decision as to whether a project may have one or more significant effects shall be based on substantial evidence in the record of the lead agency....Substantial evidence shall include facts, reasonable assumptions predicated upon facts, and expert opinion supported by facts.*
- (h) *...If there is disagreement among expert opinion supported by facts over the significance of an effect on the environment, the Lead Agency shall treat the effect as significant....*

In addition, the following section (14 CCR 15065, filed 13 July 1983, amended 27 May 1997) describes mandatory findings of significance. Situations in which “a lead agency shall find that a project may have a significant effect on the environment” include those in which

- (a) *The project has the potential to substantially degrade the quality of the environment,...[or]...reduce the number or restrict the range of an endangered, rare or threatened species.*
- (d) *The environmental effects of a project will cause substantial adverse effects on human beings, either directly or indirectly.*

“Substantial” in these cases appears to mean “of real worth, value, or effect.” Together, these sections establish the relevance of both facets of the definition: in essence, a change is significant if it is reasonably expected to have occurred or to occur in the future, and if it is of societally validated concern to someone or affects their activities or options. “Someone” in this case can also refer to society in general: the existence of legislation concerning clean water, endangered species, and environmental quality demonstrates that impacts involving these issues are of recognized concern to many people. The Environmental Protection Agency’s listing of waterways as impaired under section 303(d) of the Clean Water Act would thus constitute documentation that a significant cumulative impact has already occurred.

An approach to the definition of “significance” that has been widely attempted is the identification of thresholds above which changes are considered to be of concern. Basin plans developed under the Clean Water Act, for example, generally adopt an objective of limiting turbidity increases to within 20 percent of background levels. Using this approach, any study that shows a statistically significant increase in the level of turbidity rating curves of more than 20 percent with respect to that measured in control watersheds would document the existence of a significant cumulative impact. Such a record would show the change to be both statistically meaningful and meaningful from the point of view of what our society cares about.

Thresholds, however, are difficult to define. The ideal threshold would be an easily recognized value separating significant and insignificant effects. In most cases, though, there is no inherent point above which change is no longer benign. Instead, levels of impact form a continuum that is influenced by levels of triggering activities, incidence of triggering events such as storms, levels of sensitivity to changes, and prior conditions in an area. In the case of turbidity, for example, experiments have been carried out to define levels above which animals die; death is a recognizable threshold in system response. However, chronic impacts are experienced by the same species at levels several orders of magnitude below these lethal concentrations (Lloyd 1987), and there is likely to be an incremental decrease in long-term fitness and survival with each increment of increased turbidity. In many cases, the full implications of such impacts may be expressed only in the face of an uncommon event, such as a drought or a local outbreak of disease. Any effort to define a meaningful threshold in such a situation

would be defeated by the lack of information concerning the long-term effects of low levels of exposure.

If a threshold cannot be defined objectively on the basis of system behavior or impact response, the threshold would need to be identified on the basis of subjective considerations. Definition of subjective thresholds is a political decision requiring value-laden weighting of the interests of those producing the impacts and those experiencing the impacts.

It is important to note that an activity is partially responsible for a significant cumulative impact if it contributes an incremental addition to an already significant cumulative impact. For example, if enough excess sediment has already been added to a channel system to cause a significant impact, then any further addition of sediment also constitutes a significant cumulative impact.

Now: How Can Regulation Reverse Adverse Cumulative Effects?

In California's north coast watersheds, the prevalence of streams listed as impaired under section 303(d) of the Clean Water Act demonstrates that significant cumulative impacts are widespread in the area. Forest management, grazing, and other activities continue in these watersheds, so the focus of concern now is on how to regulate management of these lands in such a way as to reverse the impacts. Current regulatory strategies largely reflect the strategies for assessing cumulative impacts that were in place 10 years ago, and the need for changing these regulatory strategies is now apparent. Approaches to regulation that are being discussed include attainment of "zero net increase" in sediment, offsetting of impacts by mitigation, adoption of more stringent standards for specific land-use activities, and use of threshold-based methods.

The "zero-net-increase" approach is based on an assumption that no harm is done if an activity does not increase the overall level of impact in an area. This is the approach instituted to regulate sediment input in Grass Valley Creek in the Trinity Basin, where erosion rates are to be held at or below the levels present in 1986 (Komar 1992). Unfortunately, this approach cannot be used to reverse the trend of impacts already occurring because the existing trend of impact was created by the levels of sediment input present in 1986. To reverse impacts, inputs would need to be decreased to below the levels of input that originally caused the problem.

"Zero-net-increase" requirements are often linked to mitigation plans, whereby expected increases in sediment production due to a planned project are to be offset by measures instituted to curtail erosion from other sources. Some such plans even provide for net decreases in sediment production in a watershed. Unfortunately, this approach also falls short of reversing existing impacts because mitigation measures usually are designed to repair the unforeseen problems caused by past activities. It is reasonable to assume that the present plans will also result in a full complement of unforeseen problems, but the possibility of mistakes is generally not accounted for when likely input rates from the planned activities are calculated. Later, when the unforeseen impacts become obvious, repair of the

new problems would be used as mitigation for future projects. To ensure that such a system does more than perpetuate the existing problems, it would be necessary to require that all future impacts from a plan (and its associated roads) are repaired as part of the plan, not as mitigation measures to offset the impacts of future plans.

In addition, offsetting mitigation activities are usually accounted for as though the predicted impacts were certain to occur if those activities are not carried out. In reality, there is only a small chance that any given site will fail in a 5-year period. Appropriate mitigation would thus require that considerably more sites be repaired than are ordinarily allowed for in mitigation-based plans. Furthermore, mitigation at one site does not necessarily offset the kind of impacts that will accrue from a planned project. If the project is located where impacts from a given sediment input might be particularly severe, offsetting measures in a less-sensitive area would not be equivalent. Similarly, mitigation of one kind of source does not cancel the impact of another kind of source. Mitigation capable of offsetting the impacts from construction of a new road would need to include obliteration of an equal length of old road to offset hydrologic changes, as well as measures to offset short-term sediment inputs from construction and obliteration and long-term inputs from future road use.

The timing of the resulting changes may also negate the effectiveness of mitigation measures. If a project adds to current sediment loads in a sediment-impaired waterway, while the mitigation work is designed to decrease sediment loads at some time in the future (when the repaired sites would otherwise have failed), the plan is still contributing to a significant cumulative impact, irrespective of the offsetting mitigation activities. In other words, if a watershed is already experiencing a significant sediment problem, it makes little sense to use an as-yet-unfulfilled expectation of future improvement as an excuse to make the situation worse in the short term. It would thus be necessary to carry out mitigation activities well in advance of the activities which they are designed to offset so that impact levels are demonstrably decreasing by the time the unavoidable new impacts are generated.

The third approach to managing existing impacts is the adoption of more stringent standards that are based on the needs of the impacted resources. Attempts to avert cumulative impacts through the implementation of "best management practices" (BMPs) have failed in the past in part because they were based strongly on the economic needs of the impacting land uses and thus did not fully reflect the possibility that significant adverse cumulative effects might accrue even from reduced levels of impact. A new approach to BMPs has recently appeared in the form of standards and guidelines for designing and managing riparian reserves on federal lands affected by the Northwest Forest Plan (USDA and USDI 1994). Guidelines for the design of riparian reserves are based on studies that describe the distance from a forest edge over which the microclimatic and physical effects of the edge are evident, and have a principal goal of producing riparian buffer strips capable of adequately shielding the aquatic system—and particularly anadromous salmonids—from the effects of

upslope activities. Any land-use activities to be carried out within the reserves must be shown not to incur impacts on the aquatic system. Even with this level of protection, the Northwest Forest Plan is careful to point out that riparian reserves and their accompanying standards and guidelines are not in themselves sufficient to reverse the trend of aquatic habitat degradation. These measures are expected to be effective only in combination with (1) watershed analysis to identify the causes of problems, (2) restoration programs to reverse those causes and speed recovery, and (3) careful protection of key watersheds to ensure that watershed-scale refugia are present. The Northwest Forest Plan thus recognizes that BMPs alone are not sufficient, although they can be an important component of a broader, landscape-scale approach to recovery from impacts.

The final approach is the use of thresholds. Threshold-based methods would allow for altering land-use prescriptions once a threshold of concern has been surpassed. This, in essence, is the approach used on National Forests in California: if the index of land-use intensity rises above a defined threshold value, further activities are deferred until the value for the watershed is once again below threshold. Such an approach would be workable if there is a sound basis for identifying appropriate levels of land-use intensity. This basis would need to account for the occurrence of large storms because actual impact levels rarely can be identified in the absence of a triggering event. The approach would also need to include provisions for frequent review so that plans could be modified if unforeseen impacts occur.

Thresholds are more commonly considered from the point of view of the impacted resource. In this case, activities are curtailed if the level of impact rises above a predetermined value. This approach has limited utility if the intent is to reverse existing or prevent future cumulative impacts because most responses of interest lag behind the land-use activities that generate them. If the threshold is defined according to system response, the trend of change may be irreversible by the time the threshold is surpassed. In the Waipaoa case, for example, if a threshold were defined according to a level of aggradation at a downstream site, the system would have already changed irreversibly by the time the effect was visible. The intolerable rate of aggradation that Whatatutu experienced in the mid-1930's

was caused by deforestation 50 years earlier. Similarly, the current pulse of aggradation near the mouth of Redwood Creek was triggered by a major storm that occurred more than 30 years ago (Madej and Ozaki 1996). In contrast, turbidity responds quickly to sediment inputs, but recognition of whether increases in turbidity are above a threshold level requires a sequence of measurements over time to identify the relation between turbidity and discharge, and it requires comparison to similar measurements from an undisturbed or less-disturbed watershed to establish the threshold relationship.

The potential effectiveness of the strategies described above can be assessed by evaluating their likely utility for addressing particular impacts (*table 3*). In North Fork Caspar Creek, for example, suspended sediment load nearly doubled after clearcutting, with the change partly attributable to increased sediment transport in the smallest tributaries because of increased runoff and peakflows. Strategies of zero-net-increase and offsetting mitigations would not have prevented the change because the effect was an indirect result of the volume of canopy removed; hydrologic change is not readily mitigable. BMPs would not have worked because the problem was caused by the loss of canopy, not by how the trees were removed. Impacts were evident only after logging was completed, so impact-based thresholds would not have been passed until after the change was irreversible. Only activity-based thresholds would have been effective in this case: because hydrologic change is roughly proportional to the area logged, the magnitude of hydrologic change could have been managed by regulating the amount of land logged.

A second long-term cumulative impact at Caspar Creek is the change in channel form that is likely to result from past, present, and future modifications of near-stream forest stands. In this case, a zero-net-change strategy would not have worked because the characteristics for which change is of concern—debris loading in the channel—will be changing to an unknown extent over the next decades and centuries in indirect response to the land-use activities. Off-setting mitigations would most likely take the form of artificially adding wood, but such a short-term remedy is not a valid solution to a problem that may persist for centuries. In this case, BMPs, in the form of riparian buffer strips designed to maintain appropriate debris infall rates, would have been effective. Impact thresholds

Table 3—Potential effectiveness of various strategies for managing specific cumulative impacts.

Cumulative impact	Zero-net-increase	Off-setting mitigations	Impact-based Best Management Practices	Impact thresholds	Activity thresholds
Caspar Creek sediment yield increase from hydrologic change	no	no	no	no	YES
Caspar Creek channel change from altered wood regime	no	no	YES	no	no
Waipaoa flooding from channel aggradation	no	no	no	no	YES

would not have prevented impacts, as the nature of the impact will not be fully evident for decades or centuries. Activity thresholds also would not be effective, because the recovery rate of the impact is an order of magnitude longer than the likely cutting cycle.

The Waipaoa problem would also be poorly served by most of the available strategies. Once underway, impacts in the Waipaoa watershed could not have been reversed through adoption of zero-net-increase rules because the importance of earlier impacts was growing exponentially as existing sources enlarged. Similarly, mitigation measures to repair existing problems would not have been successful: the only effective mitigation would have been to reforest an equivalent portion of the landscape, thus defeating the purpose of the vegetation conversion. BMPs would not have been effective, because *how* the watershed was deforested made no difference to the severity of the impact. Thresholds defined on the basis of impact also would have been useless because the trend of change was effectively irreversible by the time the impacts were visible downstream. Thresholds of land-use intensity, however, might have been effective had they been instituted in time. If only a portion of the watershed had been deforested, hydrologic change might have been kept at a low enough level that gullies would not have formed. The only potentially effective approach in this case thus would have been one that required an understanding of how the impacts were likely to come about. De facto institution of land-use-intensity thresholds is the approach that has now been adopted in the Waipaoa basin to reduce existing cumulative impacts. The New Zealand government bought the major problem areas and reforested them in the 1960's and 1970's. Over the past 30 years the rate of sediment input has decreased significantly, and excess sediment is beginning to move out of upstream channels.

It is evident that no one strategy can be used effectively to manage all kinds of cumulative impacts. To select an appropriate management strategy, it is necessary to determine the cause, symptoms, and persistence of the impacts of concern. Once these characteristics are understood, each available strategy can be evaluated to determine whether it will have the desired effect.

Now: How Can Adverse Cumulative Effects Be Avoided?

The first problem in planning land use to avoid cumulative effects is to identify the cumulative effects that might occur from a proposed activity. A variety of methods for doing so have been developed over the past 10 years, and the most widely adopted of these are methods of watershed analysis. Washington State has developed and implemented a procedure to design management practices to fit conditions within specific watersheds (WFPB 1995), with the intent of holding future impacts to low levels. A procedure has also been developed for evaluating existing and potential environmental impacts on federal lands in the Pacific Northwest (Regional Ecosystem Office 1995). Both methods have strengths and weaknesses.

The Washington approach describes detailed methods for evaluating processes such as landsliding and road-surface erosion

and provides for participation of a variety of interest groups in the analysis procedure. Because the approach was developed through consensus among diverse groups, it is widely accepted. However, methods have not been adequately tested, and the approach is designed to consider only issues related to anadromous fish and water quality. In general, only those impacts which are already evident in the watershed are used as a basis for invoking prescriptions more rigorous than standard practices. No evaluation need be done of the potential effects of future activities in the watershed; it is assumed that the activities will not produce significant impacts if the prescribed practices are followed. The method does not evaluate the cumulative impacts that might result from implementation of the prescribed practices and does not provide for evaluating the potential of future activities to contribute to significant cumulative impacts. Collins and Pess (1997a, 1997b) provide a comprehensive review of the approach.

The Federal interagency watershed analysis method, in contrast, was intended simply to provide an interdisciplinary background understanding of the mechanisms for existing and potential impacts in a watershed. The Federal approach recognizes that which activities are appropriate in the future will depend on watershed conditions present in the future, so that cumulative effects analyses would still need to be carried out for future activities. Although the analyses were intended to be carried out with close interdisciplinary cooperation, analyses have tended to be prepared as a series of mono-disciplinary chapters.

Neither of the widely used watershed analysis methods provides an adequate assessment of likely cumulative effects of planned projects, and neither makes consistent use of a variety of methods that might be used to do so. However, both approaches are instructive in their call for interdisciplinary analysis and their recognition that process interactions must be evaluated over large areas if their significance is to be understood. At this point it should be possible to learn enough from the record of completed analyses to design a watershed analysis approach that will provide the kinds of information necessary to evaluate cumulative impacts, and thus to understand specific systems well enough to plan land-use activities to prevent future impacts.

Several requirements for successful cumulative effects analysis are already evident from observations of existing cumulative impacts. First, the potential for cumulative effects cannot be evaluated if the broader context for the impacts is not examined. To do so, an area large enough to display those impacts must be examined. Because of California's topography and geography, the most important areas for impact are at the mouths of the river basins: that is where most people live, where they obtain their water, where all anadromous fish must pass if they are to make their way upstream, and where the major transportation routes cross. These are also sites where sediment is likely to accumulate.

Second, a broad enough time scale must be evaluated if the potential for accumulation of impacts is to be recognized. In the Waipaoa case, for example, impacts were relatively minor during the years immediately following deforestation; aggradation was not evident until after a major storm had occurred. In the South Fork of Caspar Creek, the influences of logging on sediment yield and runoff

were thought to have largely disappeared within a decade. However, during the 1997-98 winter, three decades after road construction, destabilization of old roads has led to an increase in landslide frequency (Cafferata and Spittler, these proceedings). It is possible that a major sediment-related impact from the past land-use activities is yet to come. In any case, the success of a land-use activity in avoiding impacts is not fully tested until the occurrence of a very wet winter, a major storm, a protracted drought, and other rare—but expected—events. Analysis must depend heavily on the recognition and understanding of likely trends of change, and of the likely influences of episodic events on those trends.

Third, the potential for interactions between different mechanisms of change is of particular concern. In the Waipaoa case, for example, hydrologic changes contributed to a severe increase in flood hazard less because of their direct influence on downstream peak-flow discharges than because they accelerated erosion, thus leading to aggradation and decreased channel capacity. In retrospect such a change is clearly visible; in prospect, it would be difficult to anticipate. In other cases, unrelated changes combine to aggravate a particular impact. Over-winter survival of coho salmon may be decreased by simplification of in-stream habitat due to increased sediment loading at the same time that access to downstream off-channel refuges is blocked by construction of floodplain roads and levees. The overall effect might be a severe decrease in coho production, whereas if only one of the impacts had occurred, populations might have partially compensated for the change by using the remaining habitat option more heavily. In both of these cases, the implications of changes might best be recognized by evaluating impacts from the point of view of the impacted resource rather than from the point of view of the impacting land use. Such an approach allows consideration of the variety of influences present throughout the time frame and area important to the impacted entity. Analysis would then automatically consider interactions between the activity of interest and other influences, rather than focusing implicitly on the direct influence of the activity in question.

Fourth, the overall importance of an environmental change can be fully interpreted only relative to an unchanged state. In areas as

pervasively altered as northwest California and New Zealand, examples of unchanged sites are few. Three strategies can be used to estimate levels of change in such a situation. First, original conditions can be inferred from the nature of existing conditions and influences. No road-related sediment sources would have been present under natural conditions, for example, and the influence of modified riparian stand composition on woody debris inputs can be readily estimated. Second, less disturbed sites can be compared with more disturbed sites to identify the trend of change, even if the end point of “undisturbed” is not present. Third, information from analogous undisturbed sites elsewhere can often be used to provide an estimate of undisturbed conditions if it can be shown that those sites are similar enough to the area in question to be reasonable analogs.

Each of these problems is eminently solvable in any area, but solution requires expertise. Not only must the level of understanding within each disciplinary area be high enough to allow inference and creative problem-solving, but the interdisciplinary communication skills of each participant must be well-enough developed to allow the high level of interdisciplinary cooperation that is necessary to solve what is an inherently interdisciplinary problem.

Conclusions

Understanding of cumulative watershed impacts has increased greatly in the past 10 years, but the remaining problems are difficult ones. Existing impacts must be evaluated so that causal mechanisms are understood well enough that they can be reversed, and regulatory strategies must be modified to facilitate the recovery of damaged systems. Methods implemented to date have fallen short of this goal, but the growing level of concern over existing cumulative impacts suggests that an opportunity is at hand to make useful changes in approach. Results from Caspar Creek and the Waipaoa River illustrate that no single method for controlling cumulative impacts is applicable to every kind of impact. Whatever approaches are adopted for controlling cumulative impacts in an area need to be founded on an understanding the impact mechanisms present in that area.

References

- Allsop, F. 1973. **The story of Mangatu**. Wellington, New Zealand: Government Printer.
- CDF [California Department of Forestry and Fire Protection]. 1998. **Forest practice rules**. Sacramento, CA: California Department of Forestry and Fire Protection.
- Cline, R.; Cole, G.; Megahan, W.; Patten, R.; Potyondy, J. 1981. **Guide for predicting sediment yields from forested watersheds**. [Missoula?, MT]: Northern Region and Intermountain Region, Forest Service, U.S. Department of Agriculture.
- Collins, Brian D.; Pess, George R. 1997a. **Evaluation of forest practices prescriptions from Washington's watershed analysis program**. *Journal of the American Water Resources Association* 33(5): 969-996.
- Collins, Brian D.; Pess, George R. 1997b. **Critique of Washington's watershed analysis program**. *Journal of the American Water Resources Association* 33(5): 997-1010.
- Komar, James. 1992. **Zero net increase: a new goal in timberland management on granitic soils**. In: Sommarstrom, Sari, editor. *Proceedings of the conference on decomposed granitic soils: problems and solutions*; October 21-23, 1992; Redding, CA. Davis, CA: University Extension, University of California; 84-91.
- Lloyd, D.S. 1987. **Turbidity as a water quality standard for salmonid habitats in Alaska**. *North American Journal of Fisheries Management* 7(1): 34-45.
- Madej, M.A.; Ozaki, V. 1996. **Channel response to sediment wave propagation and movement, Redwood Creek, California, USA**. *Earth Surface Processes and Landforms* 21: 911-927.
- Pacific Watershed Associates. 1998. **Sediment source investigation and sediment reduction plan for the Bear Creek watershed, Humboldt County, California**. Report prepared for the Pacific Lumber Company, Scotia, California.
- Regional Ecosystem Office. 1995. **Ecosystem analysis at the watershed scale**, version 2.2. Portland, OR: Regional Ecosystem Office. 1995-689-120/21215 Region no. 10. US Government Printing Office.
- Reid, Leslie M. 1993. **Research and cumulative watershed effects**. Gen. Tech. Rep. PSW-GTR-141. Berkeley, CA: Pacific Southwest Research Station, Forest Service, U.S. Department of Agriculture.
- Scott, Ralph G.; Buer, Koll Y. 1983. **South Fork Eel Watershed Erosion Investigation**. Northern District: California Department of Water Resources.
- Stowell, R.; Espinosa, A.; Bjornn, T.C.; Platts, W.S.; Burns, D.C.; Irving, J.S. 1983. **Guide to predicting salmonid response to sediment yields in Idaho Batholith watersheds**. [Missoula?, MT]: Northern Region and Intermountain Region, Forest Service, U.S. Department of Agriculture.
- Thomas, Robert B. 1990. **Problems in determining the return of a watershed to pretreatment conditions: techniques applied to a study at Caspar Creek, California**. *Water Resources Research* 26(9): 2079-2087.
- USDA and USDI [United States Department of Agriculture and United States Department of the Interior]. 1994. **Record of Decision for amendments to Forest Service and Bureau of Land Management planning documents within the range of the northern spotted owl; Standards and Guidelines for management of habitat for late-successional and old-growth forest related species within the range of the northern spotted owl**. 1994 - 589-111/00001 Region no. 10. U.S. Government Printing Office.
- USDA Forest Service [U.S. Department of Agriculture, Forest Service]. 1988. **Cumulative off-site watershed effects analysis**. Forest Service Handbook 2509.22. Soil and water conservation handbook. San Francisco, CA: Region 5, Forest Service, U.S. Department of Agriculture.
- WFPB [Washington Forest Practices Board]. 1995. **Standard methodology for conducting watershed analysis under Chapter 222-22 WAC**. Version 3.0. Olympia, WA: Forest Practices Division, Department of Natural Resources.
- Ziemer, R.R.; Lewis, J.; Rice, R.M.; Lisle, T.E. 1991. **Modeling the cumulative watershed effects of forest management strategies**. *Journal of Environmental Quality* 20(1): 36-42.

Monitoring Watersheds and Streams¹

Robert R. Ziemer²

Abstract: Regulations increasingly require monitoring to detect changes caused by land management activities. Successful monitoring requires that objectives be clearly stated. Once objectives are clearly identified, it is important to map out all of the components and links that might affect the issues of concern. For each issue and each component that affects that issue, there are appropriate spatial and temporal scales to consider. These scales are not consistent between and amongst one another. For many issues, unusual events are more important than average conditions. Any short-term monitoring program has a low probability of measuring rare events that may occur only once every 25 years or more. Regulations that are developed from observations of the consequences of small “normal” storms will likely be inadequate because the collected data will not include the critical geomorphic events that produce the physical and biological concerns.

Regulations increasingly require monitoring to detect changes caused by land management activities. In its most useful form, monitoring is the job of determining whether some important physical, biological, or social threshold related to some issue of interest has been crossed. Watershed analysis (Regional Interagency Executive Committee 1995) is becoming a widely used approach for identifying the important issues. After the important issues are identified, it is then time to develop some detailed ideas about how those issues are affected, both temporally and spatially. Finally, it is time to decide what to measure, when to measure, where to measure, and how those measurements will be used to address the identified issue. The task is to select the appropriate measurements, at the appropriate times, and in the appropriate places to determine whether there has been an important change to the issue being addressed. A monitoring program that fails to incorporate these first steps is destined to fail. This paper discusses three issues critical to the design of successful monitoring projects: problem definition, scale considerations, and limitations of studies in small watersheds.

Mapping the Problem

Successful monitoring requires that the issue of concern be clearly stated. Once the issue is clear, it is important to map the important components and links that might affect that issue. For example, a generalized diagram of some possible important interactions between land use and “increased flood damage” can be constructed (*fig. 1*). In the specific case of the North Fork of Caspar Creek, the only land uses were timber harvest and a small length of ridge-top roads (Preface, *fig. 2*, these proceedings), and the generalized diagram can be simplified to show the potential influence of these activities (Ziemer, *fig. 7*, these proceedings).

In other watersheds, the mix of land-use activities can be more

complex. For example, in the Russian River watershed, principal land-disturbing activities are urbanization, agriculture, roads, grazing, and timber harvest (*fig. 1*). Each of these activities can affect storm runoff and routing in different ways. On a relative scale, urbanization can increase runoff much more than other activities, because paved roads, parking lots, and roofs prevent infiltration of water into the soil and result in rapid and direct runoff to the stream. Agriculture can change soil structure, increase compaction, reduce infiltration rates, and increase surface runoff and erosion. Conversion from forest to pasture can result in substantial changes in watershed hydrodynamics, including increased runoff and erosion (Reid, these proceedings). Increased human settlement in flood-prone areas can directly increase flood damage without a change in the amount of area flooded. Increased erosion can result in deposition of sediment in stream channels, increasing the elevation of the channel bed that, in turn, increases the frequency and amount of over-bank flooding. Further, alteration of stream channels by levee construction, gravel mining, removal of woody debris, and reduced floodplain storage can result in increased flooding.

A monitoring program to assess whether and how flooding has increased in a watershed will fail unless first there is an adequate understanding of the potential interactions of various land-use activities and flood damage. Once these interactions are understood, monitoring becomes much simpler and shortcuts become possible. For example, at Caspar Creek, changes in peak streamflow after logging was linked to changes in evapotranspiration and rainfall interception (Ziemer, these proceedings). Consequently, peak streamflow changes could be predicted adequately by simply tracking the proportion of the vegetation removed from the watershed each year. In another watershed experiencing different types of land use, this shortcut measurement may produce erroneous results, because changes in evapotranspiration and rainfall interception by vegetation may have little relationship to the different land use, watershed condition, and flooding.

There are numerous examples in which a simple index is purported to link land use to the issue of concern (*fig. 2*). Unfortunately, the index shortcut is often adopted too quickly on the basis of findings by others elsewhere and without adequate consideration of the local conditions. If, as in the Caspar Creek example, there is good local evidence that the index (e.g., proportion of the vegetation removed) is closely related to the target issue (e.g., changes in peak streamflow after logging), the index approach will be successful. However, if the index does not link strongly to an issue of concern, or the index is not sensitive to changing land use, then the index approach will fail.

The example of increased flood damage (*fig. 1*) is relatively simple. A more complicated issue is that of “disappearing salmon” (*fig. 3*). In this case, land-use activities such as agriculture, logging,

¹ An abbreviated version of this paper was presented at the Conference on Coastal Watersheds: The Caspar Creek Story, May 6, 1998, Ukiah, California

² Chief Research Hydrologist, USDA Forest Service, Pacific Southwest Research Station, 1700 Bayview Drive, Arcata, CA 95521. (rrz7001@axe.humboldt.edu)

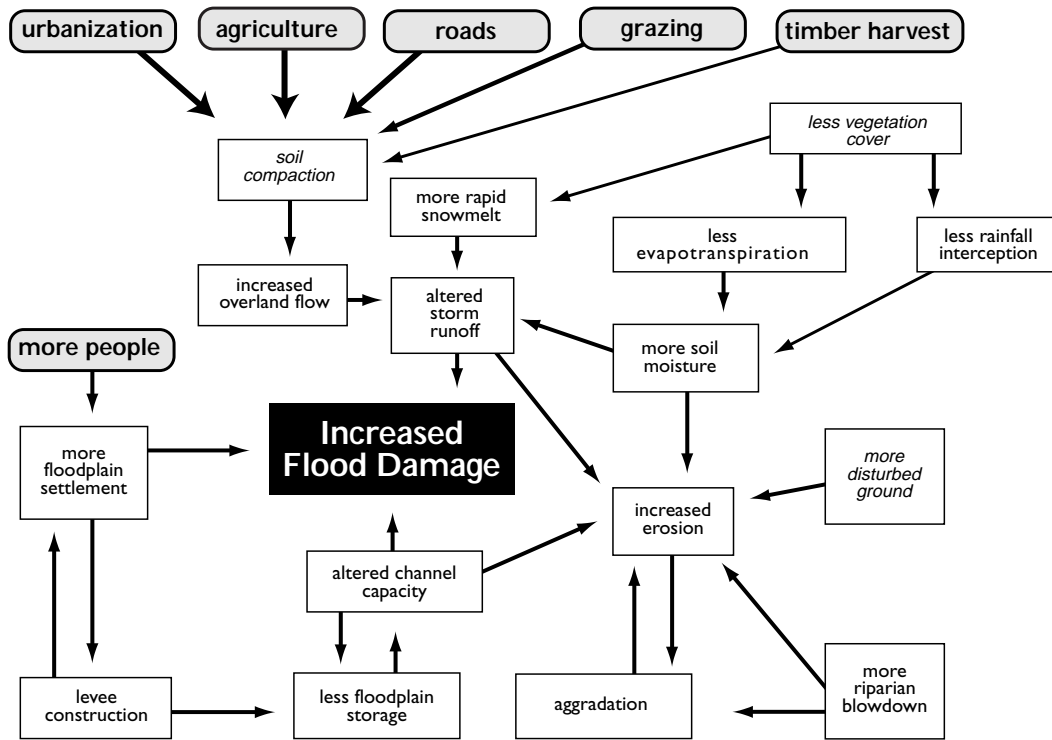

Figure 1—A generalized diagram of some possible important interactions between land use and “increased flood damage” in the Russian River watershed of northern California. Thicker arrows depict a greater relative effect of land-disturbing activity (rounded rectangles) on physical land condition (italics). Only one example, the relative effect of land-disturbing activity on soil compaction, is shown.

grazing, and urbanization potentially affect only part of the salmon’s life cycle (Ziemer and Reid 1997). An index that moves directly from land use to disappearing salmon (*fig. 4*) without considering the influence of ocean conditions, fishing (sport, commercial, subsistence), predation (marine, fresh water, terrestrial), migration blockage (dams, road culverts, channel aggradation), and additional factors, will probably be inadequate. Consequently, a monitoring program designed to measure values of an index of, for example, watershed condition, equivalent clearcut acres (ECA), total maximum daily load (TMDL), or measures of the stream channel (pools, woody debris, etc.) will likely not succeed for predicting annual variations in fish populations, because the index is unrelated to many of the principal factors that may be causing salmon to disappear. *Figure 3* itself is an abbreviated description of the numerous components that might be important to the problem of disappearing salmon. A variety of other influences could be added to the diagram and each box could be expanded to more completely display multiple interactions. For example, the “higher peak flows” box (*fig. 3*) can be expanded to become *figure 1*.

The object of this exercise is not to develop elegant textbook diagrams that describe everything that is known about peak flows or salmon. Nor are these diagrams intended to be universally applicable. The process of taking the issue of concern and then developing a map that displays how that issue might be affected by

local conditions is more important than the final map itself. A conscientious effort to understand the issue requires integrating information from representatives of many disciplines and interests. Such an exercise is a learning experience for everyone involved, and new issues will emerge that will require further consideration. For example, *figure 3* does not consider the effect of hatcheries on fish genetics and disease. The information and understanding gained will allow design of a monitoring approach that has a greatly improved chance of measuring the proper components at the proper location at the proper time.

As important as it is to determine what, when, and where to measure, it is equally important to determine what *not* to measure. In this way, what the monitoring is and is not intended to determine will be clear. If the level of understanding is adequate, those issues that are not to be addressed will not turn out to be essential to the overall success of the monitoring program. For example, early in the North Fork phase of the Caspar Creek study in northern California, we decided to measure those attributes of streamflow and sediment transport that we believed would be critical to future forest practice regulation (e.g., suspended sediment and storm flow). At the same time, we did not expect that other factors, such as summer low flow, would be as important to decisions regarding forest practice regulation as would the hydrologic response of the watershed during storms. Further, it was much more expensive to

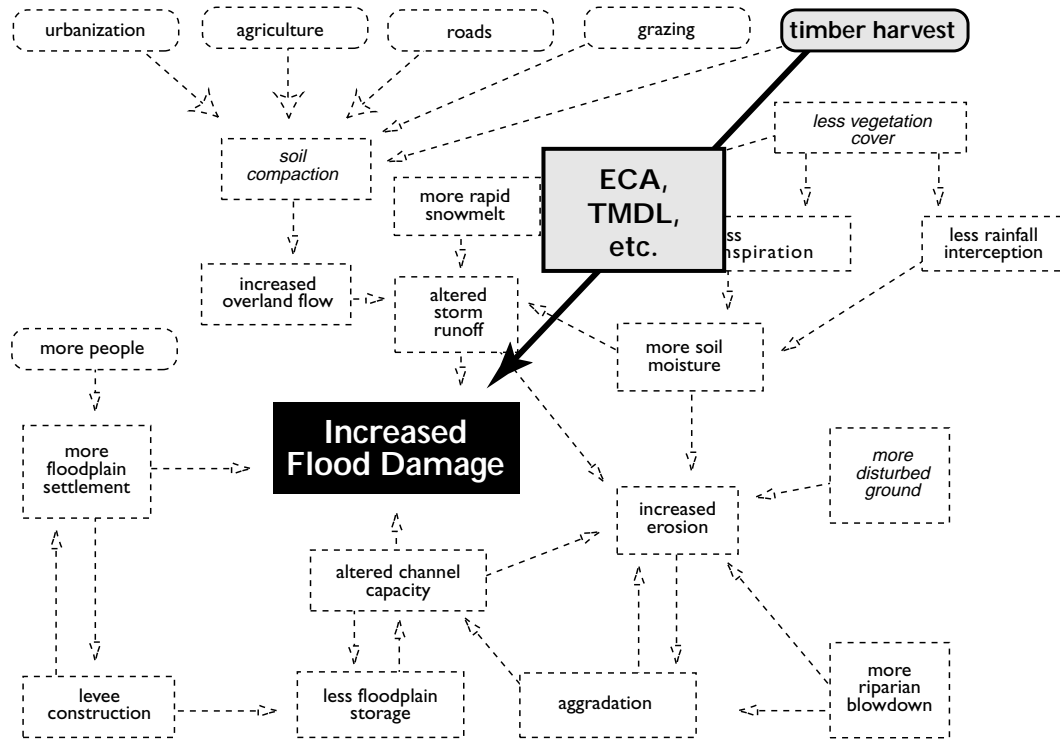

Figure 2—Example of a short cut that uses an index (e.g., equivalent clearcut acres [ECA] or total maximum daily load [TMDL]) to simplify the complex relationship between land use and “Increased Flood Damage.”

measure summer low flow accurately at each tributary in Caspar Creek because of leakage by subsurface flow through the gravel in the channel bed. Similarly, early in the study, we decided not to monitor water chemistry for the same reasons: it was expensive and we expected that changes in water chemistry resulting from timber harvest probably would not be sufficient to require changes in forest practice regulations. Subsequently, however, summer low flow (Keppeler, these proceedings) and water chemistry (Dahlgren, these proceedings) were studied in Caspar Creek. Results from those studies supported our initial guess that changes in summer low flow and chemical export after logging were minor regulatory issues.

Scale

The relevant spatial and temporal scale for each analysis depends on the specific issue being addressed. There is no one scale that is appropriate for all issues. Further, there is often no one scale that is appropriate for even a single issue. For example, a scale that is considered appropriate within a physical or biological context might not be considered appropriate within a political or social context. Failure to recognize these differing views can doom a monitoring program. Historically, many monitoring programs have been deficient because the spatial scale was too small and the temporal scale too short.

Political and Social Scales

Time. Corporations and stockholders consider quarterly profits and losses to be an important measure of corporate health. Politicians often focus on election cycles of 2, 4, or 6 years as their measure of a program’s success. Corporate managers who ignore the quarterly balance sheet or politicians who ignore the next election may find themselves out of a job. Company- and government-sponsored monitoring programs, therefore, are often expected to produce interpretable results within months to a few years.

People have short memories. The more recent the event, the more likely that it will be considered in planning. The longer the period between events, the less relevant it appears to daily life. Consequently, long-term monitoring and planning are often considered to be more a philosophical exercise than one of practical value. A flood that occurs once every 50 years is not considered by most people to be an important threat, unless it occurred last year. Long-term monitoring programs instituted after a rare event may fall victim to flagging interest as memory of the event fades. Differences in time-perception create a tension between those seeking short-term solutions and those seeking to protect long-term value.

Space. As the size of an area increases, the perceived level of importance to individuals tends to decrease. The perceived importance changes from individual to family, community, city, county, state, and nation. A

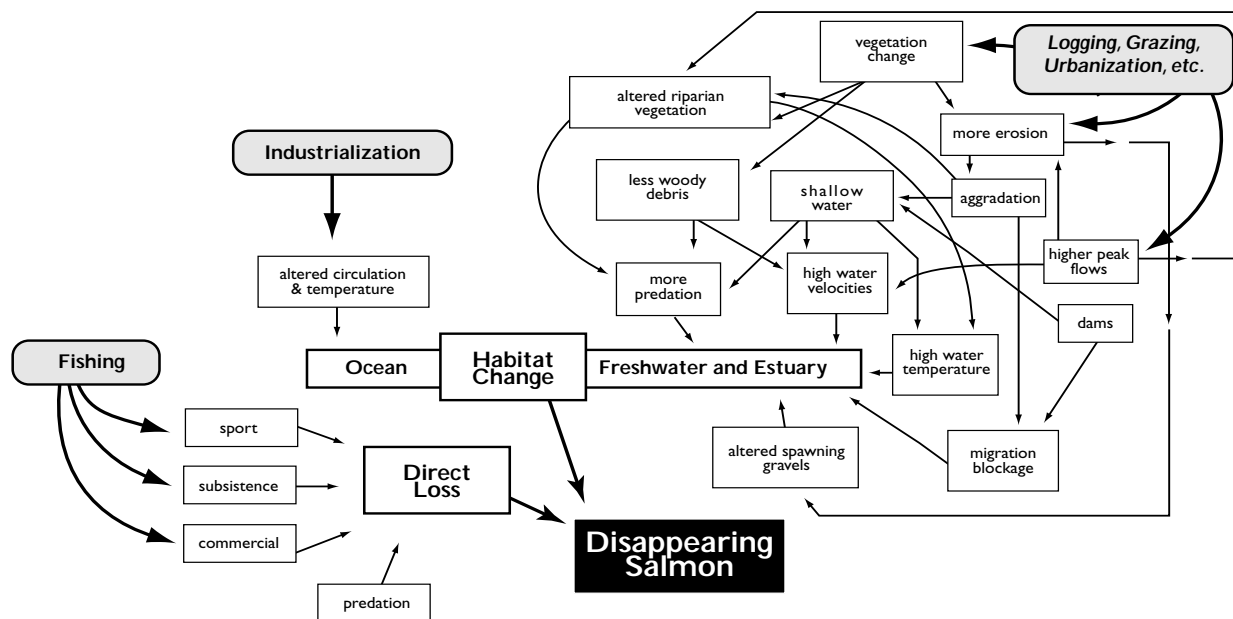

Figure 3—A generalized diagram of some possible important interactions affecting “Disappearing Salmon.”

similar hierarchy exists within and between organizations and disciplines. It is not unusual to find that issues of concern and monitoring programs stop at some political, social, organizational, or disciplinary boundary, even though such boundaries make no sense within the physical or biological context of the issue.

Physical and Biological Scales

Time. Relevant time scales vary by issue. Many environmental evaluations and monitoring programs are too brief to adequately reflect the patterns of response that are important to an issue. Data from such evaluations are almost always insufficient to identify even trends of change unless the impact is rapid and of large magnitude. Even in the case of a large, rapid response, abbreviated time scales for analysis often make it impossible for the long-term significance of the impact to be evaluated. In the case of sediment production and movement, a large infrequent storm may be required to produce significant erosion. Then, a number of large storms might be required to move the sediment from its point of origin to some location downstream. Both the erosion event and its subsequent routing result in a lag between the land management activity and its observed effect, particularly in large watersheds (Swanson and others 1992). As a classic example, Gilbert (1917) described the routing of sediment produced by placer mining in California during the 1850’s. The fine-grained sediments were transported downstream within a few decades, but the coarse-grained sediments are still being routed to the lower Sacramento River, nearly 150 years after mining ceased.

A migratory species might depend on local habitat only several weeks out of a year. The appropriate analysis for this species would focus on whether past, present, and proposed management actions affect that specific habitat for those periods of occupation each year. Activities that affect the habitat only when the animal is absent would not be relevant. Long-lived and nonmigratory species may require an analysis that evaluates the effects of management activities over all seasons for several decades, or perhaps centuries.

For many issues, unusual events are more important than average conditions. For example, the morphology of mountainous channels and much of their diversity in aquatic habitat are shaped by infrequent large storms. If a geographically isolated population of a nonmigratory resident species is removed by an unusual event, the species may not be able to reoccupy the site, even if prior and subsequent habitat conditions are perfect. Any short-term monitoring program has a low probability of measuring rare events that may occur only once every 25 years or more. Regulations that are developed from observations of the consequences of small “normal” storms will likely be inadequate because the collected data will not include the critical climatic or geomorphic events that produce the physical and biological concerns.

Space. Relevant spatial scales for analysis and monitoring also vary by issue. For example, the appropriate area in which to monitor the quality of a small community’s water supply is defined by the boundary of the watershed supplying that water and the system by which the water is delivered to the consumer. In contrast, to evaluate the causes of “disappearing salmon” (fig. 3) would require

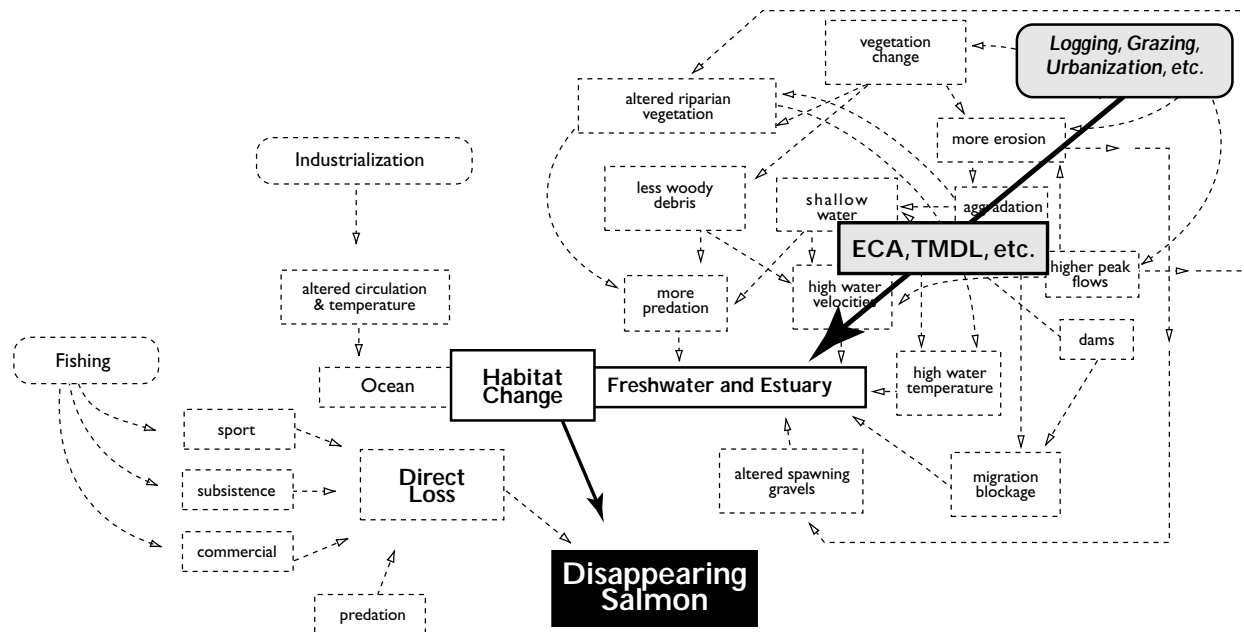

Figure 4—Example of a short cut that uses an index (e.g., equivalent clearcut acres [ECA] or total maximum daily load [TMDL]) to simplify the complex relationship between land use and “Disappearing Salmon.”

considering those factors that influence the salmon’s life cycle, including both freshwater and ocean habitats. The affected area might encompass several states, include several large river basins, and extend offshore from Alaska to southern California.

The size of disturbance units often corresponds to the size of small watersheds. Consequently, at any time it is possible to find some entire small watersheds that have been completely disturbed, some small watersheds that have not been disturbed for many years, and a number of small watersheds in varying stages of recovery from past disturbances. In contrast, only a small proportion of a large watershed is likely to have been disturbed at any one time, whereas the remainder of that watershed either has not been disturbed or is in various stages of recovery from past activities. Consequently, attempts to detect the effects of land use by observing the response of large watersheds have often been unsuccessful because large watersheds tend to represent a homogenization of land disturbances, with each large watershed having relatively similar management histories.

Temporal and spatial variability makes detecting change difficult. Variability between adjacent watersheds generally increases with increasing watershed size. For example, the coefficient of variation (*cv*; ratio of standard deviation to mean) of peak flows in the 25-ha tributaries of Caspar Creek was about half (*cv* = 0.125) of the coefficient of variation between the roughly 450-ha South Fork and North Fork watersheds (*cv* = 0.261). Hirsch and others (1990) reported that annual floods in large watersheds often have a coefficient of variation of one or more. This means that,

given equal effort, a change is more likely to be detected in small watersheds than a similar magnitude of change in large watersheds. One reason for this increased variability is that the larger the watershed, the more likely that rainfall amounts and intensities will vary within and among watersheds for any given storm. In addition, disturbances in large watersheds are more variable because of multiple types of land use, differing amounts of area disturbed in any given year, and differing character of the land being disturbed.

For each issue and each component that affects that issue, there are appropriate spatial and temporal scales to consider. These scales are not consistent between and amongst one another. For example, the duration and intensity of rainfall that produces the largest flood peaks vary with watershed size. The largest peaks in the 0.15-km² Caspar KJE tributary result from a “saturated” watershed that then receives intense rains lasting several hours, whereas those in the 275-km² Noyo River require rain storms lasting several days, and those in the 9,000-km² Eel River require prolonged rains of a week or longer. Consequently, the largest floods in a large watershed often do not correspond to the largest floods in tributary watersheds.

To characterize, for example, stormflow and sediment discharge, measurements must be made more frequently in a small watershed, because of short response times, than in a large watershed. However, for equal precision, measurements must be obtained at more locations in a large watershed, because of greater spatial and temporal variability, than in a small watershed.

The Role of Small-Watershed Studies What They Cannot Do

Observations of the response of small watersheds to changing land use cannot be accurately extrapolated to predict the response of large watersheds to the same changes in land use, because the processes of streamflow generation and routing are not represented in the same proportions. The hydrologic responses of small watersheds are governed by hillslope processes that are sensitive to land use practices. In contrast, the hydrologic responses of large watersheds are governed primarily by channel form and network pattern (Robinson and others 1995), which are less likely to be affected by land use practices outside of the channels. Runoff and sediment from small tributaries are damped, lagged, and desynchronized as they move downstream into progressively larger watersheds (Hewlett 1982).

Small-watershed studies should be considered case studies in which a few selected land-use practices are applied and are then "tested" by a discrete, but uncontrollable sequence of storm events. It is rare to find replication in small-watershed studies. First, small-watershed studies are expensive and time consuming. This results in very few watersheds being selected for study. Second, it is difficult to find several watersheds that have comparable conditions to allow for replicated treatments. Third, and most importantly, it is not possible to replicate the size and sequence of storms to which the watersheds are subjected either before or after disturbance. Most small-watershed studies have experienced the misfortune of having no large storms in the before-disturbance, after-disturbance, or both data sets (Wright 1985). The Caspar Creek study has been fortunate to experience relatively large (20-year) storms in both the before-logging and after-logging periods. However, during 36 years of study, Caspar Creek has still not experienced a truly large geomorphically significant flood.

The response of small watersheds to one type of land use, such as logging, cannot be used to predict the response of that watershed, or a different watershed, to another practice, such as agriculture, grazing, or urbanization. Each practice affects the components of watershed response differently. For example, there are few agricultural areas or practices that would produce runoff from rainfall that is comparable to that generated from a steeply sloping logged hillslope. Conversely, there are few forested areas or forestry practices that would produce runoff from rainfall that is comparable to that generated from plowed agricultural lands.

What They Can Do

Small experimental watersheds such as those at Caspar Creek, H.J. Andrews (Oregon), Coweeta (North Carolina), Hubbard Brook (New Hampshire), and Loquilla (Puerto Rico) permit detailed studies of physical and biological interactions in a relatively

controlled environment. Experimental disturbances can be imposed at a temporal and spatial scale that allows the researcher a chance of correctly identifying cause and effect. Further, although small-watershed studies are only case studies, they can establish some sideboards on the more outrageous claims that appear now and then. It is not unusual to hear claims that "logging will dry up the streams and springs" or "logging will produce devastating floods" or "logging does not increase landslides or stream sediment loads." The Caspar Creek studies have shown that none of these claims are true for the conditions found at Caspar Creek. By merging information from similar studies at other locations, generalizations can be made concerning how small watersheds function and respond to land management under varying climate, geology, and vegetation (e.g. Lull and Reinhart 1972, Hewlett 1982, Post and others *in press*).

References

- Gilbert, G.K. 1917. **Hydraulic-mining debris in the Sierra Nevada**. Prof. Paper 105. Washington, DC: Geological Survey, U.S. Department of Interior; 154 p.
- Hewlett, John D. 1982. **Forests and floods in the light of recent investigation**. In: Associate Committee on Hydrology, National Research Council of Canada. Canadian hydrology symposium: 82; 1982 June 14-15; Fredericton, New Brunswick, Canada. Ottawa, Canada: National Research Council of Canada; 543-559.
- Hirsch, R.M.; Walker, J.F.; Day, J.C.; Kallio, R. 1990. **The influence of man on hydrologic systems**. In: Wolman, M.G.; Riggs, H.C., eds. The geology of North America, vol. O-1, Surface water hydrology. Boulder, CO: Geological Society of America; 329-359.
- Lull, Howard W.; Reinhart, Kenneth G. 1972. **Forests and floods in the eastern United States**. Res. Paper NE-226. Upper Darby, PA: Northeastern Forest Experiment Station, Forest Service, U.S. Department of Agriculture; 94 p.
- Post, D.A.; Grant, G.E.; Jones, J.A. [In press]. **Ecological hydrology: expanding opportunities in hydrological sciences**. EOS, Transactions, American Geophysical Union.
- Regional Interagency Executive Committee. 1995. **Ecosystem analysis at the watershed scale: federal guide for watershed analysis**. Version 2.2, revised August 1995. Portland, OR: Regional Ecosystem Office, U.S. Government; 26 p.
- Robinson, J.S.; Sivapalan, M.; Snell, J.D. 1995. **On the relative roles of hillslope processes, channel routing, and network geomorphology in the hydrologic response of natural catchments**. Water Resources Research 31: 3089-3101.
- Swanson, F.J.; Neilson, R.P.; Grant, G.E. 1992. **Some emerging issues in watershed management: landscape patterns, species conservation, and climate change**. In: Naiman, Robert J., ed. Watershed management: balancing sustainability and environmental change. New York: Springer-Verlag; 307-323.
- Wright, Kenneth A. 1985. **Changes in storm hydrographs after roadbuilding and selective logging on a coastal watershed in northern California**. Arcata, CA: Humboldt State University; 55 p. M.S. thesis.
- Ziemer, Robert R.; Reid, Leslie M. 1997. **What have we learned, and what is new in watershed science?** In: Sommarstrom, Sari, ed. What is watershed stability? Proceedings, Sixth Biennial Watershed Management Conference; 1996 October 23-25; Lake Tahoe, CA/NV. Water Resources Center Report No. 92. Davis, CA: University of California; 43-56.

Where Do We Go from Here?¹

Raymond M. Rice²

You may have noticed that, in spite of this being a Caspar Creek conference, I spent a lot of time this morning talking about things other than watershed management research conducted at Caspar Creek. That is because, in spite of my enthusiastic support for a continued active research program at Caspar Creek, I think that it can achieve maximum benefit to society only if other aspects of the environment change. Owing, in part, to my employment since retiring from the Forest Service, I have come to see environmental problems as conflicts between the two value systems I discussed this morning. In those conflicts it seems that both industry and environmentalists rely too much on lawyers and propaganda. That is one of the things that ought to change in the future. But, before getting into such as that I would like to talk about Caspar Creek.

Things may have to be relatively quiet there for a few years while the effects of the recent logging in the North Fork diminish. That does not mean that nothing will be going on. You have heard about some of the ongoing studies today. During the rainy season six stream gaging stations will be in operation in addition to the main gages on the North and South Forks, which will operate year round. These stations will monitor both streamflow and suspended sediment. In addition, there will be three precipitation stations and one station each recording solar radiation, air temperature, water temperature, subsurface pipe flow, and soil moisture tension. Bedload transport will be recorded when any flows occur that are larger than those previously measured. Annually, the sediment accumulation in the North and South Fork weir ponds will be surveyed, as will changes in channel morphology in selected reaches of the streams. These measurements will provide the continuity that makes experimental watershed data increasingly valuable as the lengths of their records increase. But length of records is not the primary virtue of these data. It is their high quality and the wealth of ancillary data that sets them apart.

My candidate for the main goal of future research in the North and South forks of Caspar Creek is to make of them a continuing study of the two main opposing silvicultural systems: even- and uneven-aged management. If this proposed study were undertaken, things might not be quiet in Caspar Creek very long. The South Fork has had one partial cut more than 25 years ago and is ready for another. The North Fork already has no adjacency problems; therefore, additional clearcuts could be made at any time. Although it is true that the previous cut in the South Fork was not a selection

cut, future cuts could converge on that ideal. While additional selection harvesting in the South Fork is occurring, comparable volumes could be clearcut in the North Fork. There would be periodic analyses using all the data to date to see how the two systems stack up. I hope that these analyses would include biological concerns as well as hydrologic effects. My reason for this proposal is that the past paired-watershed approach leaves too much wiggle room for people inferring the effects of the two silvicultural systems in the real world. One side says that the repeated entries of uneven-aged management result in greater disturbance. The other side counters that even-aged management does not really mean only one entry per rotation; actually there are thinnings and other intermediate cuts. In time, the program I propose would test the validity of these arguments.

I have heard some grumbling about this plan based on the fact that the South Fork was logged before the modern forest practice rules and that the old roads in the South Fork are now falling apart. Consequently, the concern is that these conditions would make uneven-aged management look bad, because of past practices that are no longer considered acceptable. I would like to respond to those misgivings in four ways. First, where were such concerns 20 years ago when Forest Tilley and I proposed a study of even- and uneven-aged management on Parlin Creek? Second, there are hundreds of areas on the north coast with histories just like the South Fork's. Consequently, the information gained will be relevant to current conditions on a substantial portion of lands previously logged. Third, the new gages contemplated on the tributaries in the South Fork can be used to estimate the effects of uneven-aged management uncontaminated by the South Fork's history. Lastly, as the years pass and repeated entries are made, it will become clearer which silvicultural system adapts most easily to new environmental and production requirements that will likely arise in the future.

It is in our interest to not limit our concerns about the future to Caspar Creek. At a minimum we should support the continuation of research at other experimental watersheds in the Pacific Northwest. It is not just comforting when Caspar Creek findings are supported elsewhere. It gives assurance that what we have measured at Caspar Creek is not a fluke of the site or the weather.

The U.S. Geological Survey (USGS) collects almost all streamflow and sediment data in the United States. The USGS, by the nature of its mission, is collecting its data from natural stream channels draining large watersheds. As a consequence, they are unable to attain the accuracy of the weirs and flumes in Caspar Creek. Scientists using USGS data *do* have the opportunity study complex watersheds on a scale impossible in Caspar Creek. The two data sources are, therefore, complementary. Although Caspar Creek data have increased in quantity and quality since the study began in 1963, the quantity of USGS data has been shrinking. That is

¹ An abbreviated version of this paper was presented at the Conference on Coastal Watersheds: The Caspar Creek Story, May 6, 1998, Ukiah, California.

² Formerly Chief Research Hydrologist, Pacific Southwest Research Station, USDA Forest Service, Arcata, California, and now retired. Current address: 44 Robert Court East, Arcata, CA 95521. (ray@northcoast.com)

especially true with respect to estimates of sediment discharge. In 1963, streamflow was measured by the USGS on 97 coastal streams in northwestern California. Suspended sediment was measured at 10 of them. Of the 10, estimates of total annual sediment discharge were made at seven gaging stations, the 6 winter months were monitored at two stations, and 57 samples were collected at another. By 1974, the number of stations where streamflow was measured had dropped to 70, but sediment was measured at 19 stations. Of these, 15 produced total annual sediment estimates and 60 samples were divided among the remaining four stations. In 1996, 52 streams were being monitored, and annual sediment load was computed at only one: Grass Valley Creek. Throughout the remainder of the California coast, from Oregon to San Francisco, there were only 19 daily estimates of suspended sediment discharge scattered among six gaging stations. When considering “where do we go from here,” I wonder if this is a trend that will or should continue? I think it should not. With the impact of watershed disturbances on anadromous fisheries being hotly debated, we should be collecting more data, not less. Small experimental watersheds cannot help much here. Most of what affects anadromous fisheries occurs elsewhere. Information on large watersheds is necessary to answer those and other questions that cannot be resolved in a couple of 500-ha watersheds.

In this era of shrinking government budgets, we should be considering from where needed large watershed data might come. The USGS is not the only possible source of data on large watersheds. In the past, two timber companies on the north coast launched their own watershed-monitoring programs. One, in particular, was a well-designed paired-watershed study. Both companies invested a lot of time and resources collecting calibration data but, as far as I know, both have abandoned their studies without completing their experiments. That was a consequence, I suspect, of the “quarterly report” mentality of much of American industry. I have no way of knowing whether the completion of those studies would have been cost-effective for those companies, but my bias is that they would have been — especially for one of them. Certainly, aborting the studies after making substantial investments in them was not cost-effective. If companies are reluctant to make the necessary long-term commitment to do their own watershed monitoring, I think they would be well advised to use their considerable political muscle to reverse the decline in USGS stream gaging.

Timber companies may not have suitable watersheds within their properties. That does not mean that they cannot attempt to measure sediment risks associated with their management—if only to estimate their future legal fees. Erosion studies can yield them considerable insight into possible sediment problems—or lack thereof. All companies make a lot of decisions—in road maintenance, in particular—based on likely sedimentation effects. By having their own well-designed erosion studies they can gain insight into the cost-effectiveness of what they are doing. Another way that the industry could foster more fact-based analyses of hydrologic problems would be to measure precipitation. Practically all of the rain gages in the Pacific Northwest are in valleys or on the coast. Industry owns the hills. It would be helpful to *know* what is happening up there rather than having to assume high-elevation rainfall amounts.

And now, my most outrageous “where do we go from here.” The Sierra Club or any like-minded environmental group could resort to their own studies. Wouldn’t data be more effective than scare tactics supported by photos of the operation of Murphy’s Law? These groups certainly have the smarts and the manpower for such an undertaking. Because environmental groups are concerned about the need for more environmental protection, they should be eager to try to collect *valid* data demonstrating that need. And, if their fears are not borne out by the data, imagine their relief. To be sure, I doubt that timber companies would allow environmentalists access to their properties to collect data, but I doubt whether the Forest Service, or Bureau of Land Management, or State agencies could deny access to public lands in their jurisdiction.

I am sure that much of the foregoing is wishful thinking, which stems from my fondness for quantitative analyses of problems. And it is possible that even if my proposals were implemented, they would do little to reduce the rancor of environmental debates. Basic value systems do not change that readily, and even the best data will not be without some uncertainty and room for alternative interpretations. Granting all that, it still seems to me that “where do we go from here” ought to be in the direction of more factually based debates about forest and environmental protection.

Publications Related to Caspar Creek

Ingrid Morken¹ and Robert R. Ziemer²

Albright, Jeffrey S. 1992. **Storm runoff comparisons of subsurface pipe and stream channel discharge in a small, forested watershed in northern California.** Arcata, CA: Humboldt State University; 118 p. M.S. thesis.

Pipe discharge, stream discharge, and rainfall were measured for three winter storm seasons in the Caspar Creek watershed. Comparisons of pipe discharge and stream discharge for 22 storm events indicated that pipes respond dynamically to rainfall inputs. Pipes convey a substantial volume of runoff from study swales.

Key Terms: pipeflow, storm runoff, subsurface flow

Anderson, H.W. 1960. **Proposed program for watershed management research in the lower conifer zone of California.** Tech. Paper 46. Berkeley, CA: Pacific Southwest Forest and Range Experiment Station, Forest Service, U.S. Department of Agriculture; 21 p.

A 10-year program is proposed for California's Lower Conifer Zone that establishes experimental watersheds in four commercial timber areas: southern Sierra, northern Sierra, interior Douglas-fir, and coastal redwood-Douglas-fir regions. Caspar Creek became the experimental watersheds in coastal redwood-Douglas-fir region.

Key Terms: experimental watersheds

Anonymous. 1964. **Second progress report 1963-64, cooperative watershed management in the lower conifer zone of California.** Berkeley, CA: Pacific Southwest Forest and Range Experiment Station, Forest Service, U.S. Department of Agriculture; 19 p.

Describes establishment and first year's data from the new Caspar Creek Experimental Watersheds, including the stream habitat study conducted by Dr. Kenneth Watt, University of California, Davis.

Key Terms: experimental watersheds, stream habitat

Anonymous. 1987. **Caspar Creek: discovering how watersheds respond to logging.** Forestry Research West, August 1987. Berkeley, CA: Pacific Southwest Forest and Range Experiment Station, Forest Service, U.S. Department of Agriculture.

This pamphlet provides a historical overview of the Caspar Creek watershed study, including results and future plans of the project. The findings greatly illuminate the extent and nature of the hydrologic impact, erosion, and stream sedimentation for a northern California basin undergoing a "typical" logging operation. Long-term investigations of logging effects on the Caspar Creek watershed will provide forest managers, public policy makers, and private enterprise an empirical basis on which to formulate sound logging practices.

Key Terms: streamflow, sedimentation, logging, roads, cumulative watershed effects, fisheries

Anonymous. 1988. **Caspar Creek: how a northwestern California watershed responds to logging.** [20-minute video.] San Francisco, CA: Luba Productions. Available from: U.S. Forest Service Video Library, 800-683-8366.

This video presents the hydrologic impacts of logging in the northern California watershed of Caspar Creek from the beginning of the Caspar Creek watershed study in 1962 to the ongoing research in 1988. The effects of road building and logging on sedimentation, streamflow, and cumulative effects are discussed as well as future studies on fisheries.

Key Terms: sedimentation, streamflow, cumulative watershed effects, fisheries, logging, roads

Baumann, R.W.; Bottorff, R.L. 1997. **Two new species of Chloroperlidae (Plecoptera) from California.** Great Basin Naturalist 57(4): 343-347.

Two new species in the family *Chloroperlidae* (stoneflies) are described. One species, *Sweltsa pisteri*, was initially identified after collection from South Fork Caspar Creek. Detailed illustrations, observations, and comparisons to similar species are provided.

Key Terms: stoneflies, biology, macroinvertebrates

Bottorff, R.L.; Knight, A.W. 1996. **The effects of clearcut logging on stream biology of the North Fork of Caspar Creek, Jackson Demonstration State Forest, Fort Bragg, CA—1986 to 1994.** Unpubl. Final Rept. prepared for the Calif. Dept. of Forestry and Fire Protection, Contract No. 8CA3802. Sacramento, CA. 177 p.

The objective of the North Fork Caspar Creek biological study was to determine whether logging treatments (1989-1991) within the drainage basin caused changes in three components of stream structure and function: (1) the benthic macroinvertebrate community, (2) leaf litter processing rates, and (3) the benthic algal community. This report describes the results of 8 years of study (1987-1994) on the stream biology of North Fork Caspar Creek, including three pre-treatment years and five post-treatment years.

Key Terms: stream ecology, logging

Brown, David Lawrence. 1995. **An analysis of transient flow in upland watersheds: interactions between structure and process.** Berkeley, CA: University of California; 225 p. Ph.D. dissertation.

Field observations of responses of pore pressure to rain events at two diverse experimental watersheds indicate that heterogeneous soil and geologic materials affect storm runoff responses. The results of a series of parametric simulations based on a physically based numerical subsurface flow model suggest that significantly macroporous soils may enhance the contribution of a soil horizon or geologic material to hillslope discharge. Antecedent moisture conditions, channel bank geometry, and lateral heterogeneities in soil hydraulic properties affect the subsurface flow paths.

Key Terms: subsurface flow, storm runoff, modeling

¹ Member, Americorps USA, The Watershed Stewards Project, c/o Pacific Southwest Research Station, 802 N. Main Street, Fort Bragg, CA 95437.

² Chief Research Hydrologist, USDA Forest Service, Pacific Southwest Research Station, 1700 Bayview Drive, Arcata, CA 95521. (rrz7001@axe.humboldt.edu)

Burns, J.W. 1970. **Spawning bed sedimentation studies in northern California streams.** California Fish and Game 56(4): 253-270.

Changes in the size composition of spawning bed materials in six coastal streams, including Caspar Creek, were monitored for 3 years to determine the effects of logging on the habitat of silver salmon (Coho), and trout (steelhead). Spawning bed composition in four test streams changed after logging, roughly in proportion to the amount of streambank disturbance. Sedimentation was greatest during periods of road construction near streams and removal of debris from streams, confirming the need for special measures to minimize erosion during such operations.

Key Terms: sedimentation, logging, channel morphology, fisheries

Burns, J.W. 1971. **The carrying capacity for juvenile salmonids in some northern California streams.** California Fish and Game 57(1): 44-57.

Standing crops of three species of juvenile salmonids were examined in seven coastal streams [including Caspar Creek] to define the natural carrying capacity of these streams, and to develop methods of population comparison and prediction that could be used to determine the effects of road construction and logging on salmon and trout production. Biomass per unit of surface area was found to be the best method of expressing carrying capacity. Not all streams reached carrying capacity, and salmonid biomass was highly variable, suggesting that it would be difficult to attribute a change in carrying capacity under 50 percent to anything but natural variation.

Key Terms: fisheries, roads, logging

Burns, J.W. 1972. **Some effects of logging and associated road construction on northern California streams.** Transactions, American Fisheries Society 101: 1-17.

The effects of logging and associated road construction on four California trout and salmonid streams were investigated from 1966 through 1969. This study included measurements of streambed sedimentation, water quality, fish food abundance, and stream nursery capacity. Sustained logging prolonged adverse conditions in one stream and delayed stream recovery. Other effects of logging on anadromous fish populations are discussed.

Key Terms: fisheries, sedimentation, logging, roads

Cafferata, P.H. 1984. **The North Fork of Caspar Creek: a cooperative venture between CDF and USFS.** Jackson Demonstration State Forest Newsletter, No. 15, August 1984. p. 1-2.

The California Department of Forestry (CDF) and the USDA Forest Service (USFS) continue to be equal partners in implementing the North Fork phase of the Caspar Creek Watershed Study. Parshall flume sites and pumping samplers have been installed in the North Fork to aid in measuring stream discharge and suspended sediment load, respectively. The cooperative link of CDF and USFS provides a broad, effective resource base for studying "cumulative effects" and sediment transport mechanisms operating in a small logged watershed.

Key Terms: instrumentation, cumulative watershed effects, sedimentation

Cafferata, P.H. 1987. **Update on the Caspar Creek watershed study.** Jackson Demonstration State Forest Newsletter, No. 27, October 1987. p. 1-4.

This article focuses on studies taking place in the North Fork of Caspar Creek following clearcutting in selected sub-basins between 1989 and 1994. The primary study is on cumulative effects, and includes the sediment impacts on the channel system that occur downstream from

the locations of the actual logging and are transmitted through the stream system. Studies on channel morphology, biology of the creek, and hillslope hydrology also are described.

Key Terms: cumulative watershed effects, channel morphology, stream ecology, subsurface flow

Cafferata, Peter. 1990. **Graduate theses produced from research conducted on Jackson Demonstration State Forest.** Jackson Demonstration State Forest Newsletter, No. 36, January 1990. p. 4-8.

A primary goal for Jackson Demonstration State Forest (JDSF) is to carry out research on the various aspects of forestry in the redwood region. In this article, graduate theses produced from research conducted on JDSF are cited and annotated. Research topics include watersheds, soils, stream ecology, redwood ecology, silviculture, forest entomology, and forest pathology.

Key Terms: redwood silviculture, watershed studies, stream ecology, terrestrial biology, soils

Cafferata, Peter. 1990. **Temperature regimes of small streams along the Mendocino coast.** Jackson Demonstration State Forest Newsletter, No. 39, October 1990. p. 4-7.

Stream temperature has been measured in the Caspar Creek drainage periodically over the past 25 years. Review of these data collected from western Mendocino County illustrates much about the temperature regimes of small coastal drainages, and how timber harvesting affects them. This article gives a synopsis of these studies and summarizes reasons for concern. Presented is a model currently in use by the USDA Forest Service to predict changes in maximum summer temperatures resulting from canopy reductions.

Key Terms: stream temperature, fisheries, logging

Cafferata, Peter H.; Spittler, Thomas E. 1998. **Logging impacts of the 1970's vs. the 1990's in the Caspar Creek watershed.** In: Ziemer, Robert R., technical coordinator. Proceedings of the conference on coastal watersheds: the Caspar Creek story, 1998 May 6; Ukiah, CA. Gen. Tech. Rep. PSW GTR-168. Albany, CA: Pacific Southwest Research Station, Forest Service, U.S. Department of Agriculture; 103-115.

The frequency of landslides greater than 76 m³ to date has not been substantially different between the clearcut units and the uncut control subwatersheds for the North Fork of Caspar Creek. The volume of sediment discharged by landslides to date has been about the same, 21 m³ ha⁻¹ from the uncut units and 19 m³ ha⁻¹ from the harvested areas. Long-term monitoring will determine if these trends continue with much larger stressing storm events. For perspective, the largest landslide mapped in the North Fork watershed, a debris flow that dammed the creek for thousands of years, was on the order of 1,000,000 to 5,000,000 m³— over three orders of magnitude larger than the largest landslide observed during the study.

Key Terms: landslides, slope stability, logging, roads, sediment, geomorphology

Cafferata, P.; Walton, K.; Jones, W. 1989. **Coho salmon and steelhead trout of JDSF.** Jackson Demonstration State Forest Newsletter, No. 32, January 1989. p. 1-7.

Spawning and rearing habitat for anadromous fish is the dominant use of Jackson Demonstration State Forest's (JDSF) many miles of streams. Both Coho (silver) salmon and steelhead migrate from the ocean up the rivers to spawn. This article summarizes life histories of Coho salmon and steelhead and describes the fisheries activities on

JDSF. Fisheries activities on Caspar Creek include downstream migrant studies and standing crop surveys.

Key Terms: fisheries, stream restoration, stream ecology

Dahlgren, Randy A. 1998. **Effects of forest harvest on biogeochemical processes in the Caspar Creek Watershed.** Unpubl. Draft Final Rept. prepared for the Calif. Dept. of Forestry and Fire Protection. Agreement No. 8CA17039. Sacramento, CA. 151 p.

Forest harvest practices are often implicated as having adverse impacts on sensitive aquatic communities and on the long-term sustainability of forest ecosystems. The primary purpose of this research was to examine the effects of forest harvest and post-harvest management practices on biogeochemical processes. Results provide information to understand the complex interactions that occur in nutrient cycling processes at the ecosystem scale.

Key Terms: biogeochemical processes, logging, nutrient cycling, water quality

Dahlgren, Randy A. 1998. **Effects of forest harvest on stream-water quality and nitrogen cycling in the Caspar Creek watershed.** In: Ziemer, Robert R., technical coordinator. Proceedings of the conference on coastal watersheds: the Caspar Creek story, 1998 May 6; Ukiah, CA. Gen. Tech. Rep. PSW GTR-168. Albany, CA: Pacific Southwest Research Station, Forest Service, U.S. Department of Agriculture; 45-53.

The effects of forest harvest on stream water quality and nitrogen cycling were examined for a redwood/Doug fir ecosystem in the North Fork, Caspar Creek experimental watershed. Stream water samples were collected from treated (e.g., clearcut) and reference (e.g., non-cut) watersheds, and from various locations downstream from the treated watersheds to determine how far the impacts of these practices extended. Additionally, a detailed nutrient cycling study was performed in a clearcut and reference watershed to gain insights into changes in nitrogen cycling following harvesting activities.

Key Terms: streamflow, cumulative watershed effects, nutrient cycling, logging, nitrogen, calcium

Dorn, R. 1969. **Evaluation of air and water temperatures on Caspar Creek from 1965-1968.** Unpubl. Rept. Cooperative Fisheries Unit, Humboldt State University, Arcata, CA. 17 p.

Key Terms: watershed studies, temperature, roads

Duan, J.; Ziemer, R.R.; Grant, G.E. 1997. **Hydrologic responses of large drainage to clearcutting: a modeling perspective.** EOS, Transactions, American Geophysical Union 78(46): F314.

Hydrologic responses of watersheds at the 100- to 1000-km² scale using a river routing model based on knowledge derived from paired-watershed studies at the 10- to 100-ha scale are presented. Primary results demonstrate both scale-independent and dependent changes in runoff volume, peak flow size, and timing in response to various scenarios of cutting pattern and proportion of area cut.

Key Terms: watershed studies, storm runoff, peak flow, logging

Eads, R.E. 1991. **Controlling sediment collection with data loggers.** In: Fan, S.; Kuo, Y.H., eds. Fifth Federal Interagency Sedimentation Conference Proceedings, 1991 March 18-21, Las Vegas, NV. Washington, DC: Federal Energy Regulatory Commission; 2-41 to 2-48.

Sampling efficiency in many types of hydrologic data collection can be improved using a programmable data logger. Low-power requirements, ease of programming, and the increased flexibility of connecting multiple

sensors also can improve data collection in remote locations.

Key Terms: instrumentation, sampling, streamflow, suspended sediment

Eads, Rand E.; Boolootian, Mark R. 1985. **Controlling suspended sediment samplers by programmable calculator and interface circuitry.** Res. Note PSW-376. Berkeley, CA: Pacific Southwest Forest and Range Experiment Station, Forest Service, U.S. Department of Agriculture; 8 p.

Automatic pumping samplers can improve the collection of data on suspended sediment when operated at fixed time intervals. A programmable calculator controls the collection of pumped suspended sediment samples and records streamflow data. Wiring schematic, component list, and program listing are included.

Key Terms: instrumentation, sampling, suspended sediment, streamflow

Eads, Rand E.; Boolootian, Mark R.; Hankin, Steven C., inventors; United States of America, assignee. 1987. **Means and method of sampling flow related variables from a waterway in an accurate manner using a programmable calculator.** U.S. patent 4,660,422. Apr. 28. 9 p. Int. Cl.4 G01N 1/44.

A programmable calculator connected to a pumping sampler by an interface circuit board runs a sediment-sampling program stored therein. Suspended sediment sample collection is controlled by a Selection At List Time (SALT) scheme in which the probability of taking a sample is proportional to its estimated contribution to total sediment discharge, or according to accumulated predicted sediment weight. Stage height is also measured and is recorded according to a set scheme.

Key Terms: instrumentation, sampling, suspended sediment, streamflow

Eads, Rand E.; Thomas, Robert B. 1983. **Evaluation of a depth proportional intake device for automatic pumping samplers.** Water Resources Bulletin 19(2): 289-292.

A depth proportional intake boom for portable pumping samplers was used to collect suspended sediment samples in two coastal streams for three winters. This equipment maintains the intake nozzle at the same proportion of water depth regardless of stage. Compared to data taken with depth integrated hand samples, the data taken by pumped samplers with boom-mounted intakes showed higher concentrations. Results suggested that cross-sectional sampling can give high precision with proper placement and calibration of a boom-mounted intake.

Key Terms: instrumentation, sampling, suspended sediment, streamflow

Fisher, Jason C. 1997. **A one-dimensional model of subsurface hillslope flow.** Unpublished Final Report. Redwood Sciences Laboratory, Pacific Southwest Research Station, USDA Forest Service, Arcata, CA. 62 p.

A one-dimensional, finite difference model of saturated subsurface flow within a hillslope was developed. The model uses rainfall, elevation data, a hydraulic conductivity, and a storage coefficient to predict the saturated thickness in time and space. The model was tested against piezometric data collected in a swale located in the headwaters of the Caspar Creek watershed and was limited in its ability to reproduce historical piezometric responses.

Key Terms: hillslope hydrology, subsurface flow, modeling

Graves, D.S.; Burns, J.W. 1970. **Comparison of the yields of downstream migrant salmonids before and after logging and road construction on the South Fork Caspar Creek, Mendocino County.** Inland Fisheries Admin.: Rept. 70-3. 11 p. Sacramento, CA: Calif. Dept. of Fish and Game.

Yields of juvenile steelhead and silver (Coho) salmon emigrants were compared in the South Fork of Caspar Creek, before and after the construction of a logging road along the stream. Numbers, lengths, and age-class structures of the juvenile salmonids were compared. The possible effects of stream disturbance on the size of migrants were also investigated.

Key Terms: logging, roads, fisheries, stream ecology

Hardison, Karen D. 1982. **Effects of timber harvesting on the lag time of a Caspar Creek watershed...a study in progress.** Jackson Demonstration State Forest Newsletter, No. 8, September 1982. p 1-3.

In this study, two measurements of lag time are analyzed for each storm in the Caspar Creek Watershed. One is the time separation between the center of mass of rainfall and the center of mass of total runoff, the other is the time separation between the center of mass of rainfall and the center of mass of rising limb runoff. Analysis of any change in lag time after roadbuilding and logging will indicate changes in the processes involved in stormflow at this site.

Key Terms: storm runoff, logging, streamflow, roads

Harvey, B.C.; Nakamoto, R.J. 1996. **Effects of steelhead density on growth of Coho salmon in a small coastal California stream.** Transactions, American Fisheries Society 125: 237-243.

Weight change in age-0+ Coho salmon (*Oncorhynchus kisutch*) at about natural density was negatively related to the density of juvenile steelhead (*O. mykiss*) in a 6-week experiment conducted in July-August 1993 in the North and South forks of Caspar Creek. In the North Fork, Coho salmon weight change was positive in zero density steelhead treatments, zero in 1X treatments, and negative in 2X treatments. Coho salmon weight change in the South Fork was less favorable than in the North Fork but also negatively related to steelhead density.

Key Terms: fisheries, stream ecology

Harvey, Bret C.; Nakamoto, Rodney J. 1997. **Habitat-dependent interactions between two size-classes of juvenile steelhead in a small stream.** Canadian Journal of Fisheries and Aquatic Sciences 54(1): 27-31.

The presence of small steelhead influenced the growth of larger juvenile steelhead during a 6-week experiment conducted in North Fork Caspar Creek in 1994. In fenced replicate deep-stream sections in this small stream, growth of the larger steelhead was greater in treatments in which small steelhead constituted half of the total biomass of fish than in treatments with an equal biomass composed entirely of larger fish. The advantage of large body size in intraspecific interactions among steelhead does not exist in all types of habitat, and interactions between the two size-classes may contribute to lower abundance of large juveniles in streams where aggradation reduces water depth.

Key Terms: fisheries, stream ecology

Henry, Norm. 1991. **Using global positioning system technology for watershed mapping in Caspar Creek.** Jackson Demonstration State Forest Newsletter, No. 43, October 1991. p. 4-6.

Global positioning system (GPS) technology is described, and GPS use in the Caspar Creek Watershed is demonstrated. The cumulative effects study and several other studies of the North Fork phase require accurate mapping and periodic map updating of the watershed

features and disturbances. The watershed features surveyed using GPS technology are now accurately located in relation not only to other objects in the watershed but also to a regional and global frame of reference.

Key Terms: instrumentation, mapping

Henry, Norm. 1998. **Overview of the Caspar Creek watershed study.** In: Ziemer, Robert R., technical coordinator. Proceedings of the conference on coastal watersheds: the Caspar Creek story, 1998 May 6; Ukiah, CA. Gen. Tech. Rep. PSW GTR-168. Albany, CA: Pacific Southwest Research Station, Forest Service, U.S. Department of Agriculture; 1-9.

This paper describes the history, site characteristics, major events, equipment, and sampling systems used during the South Fork and North Fork phases of the Caspar Creek study from 1962 through 1998.

Key Terms: paired watersheds, research, streamflow, sediment, precipitation

Henry, N.; Sendek, K. 1985. **Caspar Creek Watershed Study—North Fork Phase, Jackson Demonstration State Forest, Status and Plans, 1983-1990.** Calif. Forestry Note No. 96. Sacramento, CA: Calif. Dept. of Forestry and Fire Protection; 9 p.

The North Fork phase of the Caspar Creek Watershed Study for 1983 to 1990 uses an extensive network of flumes with pumping samplers to monitor the impacts of clearcutting a portion of the North Fork. Principal objectives are to identify sediment sources, and evaluate the magnitude and movement of sediment through the watershed. A "cumulative" effects hypothesis tested as clearcutting progresses from the headwaters to the weir.

Key Terms: suspended sediment, streamflow, sampling, cumulative watershed effects, logging, roads

Hess, Lloyd J. 1969. **The effects of logging road construction on insect drop into a small coastal watercourse.** Arcata, CA: Humboldt State University; 58 p. M.S. thesis.

The purpose of this paper is to relate logging practices to fish management by ascertaining the effect of logging road construction on the drop of insects into a stream. On the South Fork of Caspar Creek, the number of insects falling into the stream greatly increased after a logging road was built. The family *Chironomidae* showed the most significant increase of the families studied.

Key Terms: stream ecology, roads, logging, fisheries

Hopkins, Walt; Bowden, Kenneth L. 1962. **First progress report, 1961-1962, cooperative watershed management in the lower conifer zone of California.** Berkeley, CA: Pacific Southwest Forest and Range Experiment Station, Forest Service, U.S. Department of Agriculture; 10 p.

The Caspar Creek study, "Study 2-1, a study of logging effects upon streamflow, sedimentation, fish life and fish habitat in the north coast redwood-Douglas-fir forest type Jackson State Forest, Fort Bragg, California" was one of the first studies undertaken by the new Lower Conifer research project.

Key Terms: experimental watersheds

Kabel, C.S.; German, E.R. 1967. **Caspar Creek study completion report.** Marine Resources Branch Administrative Report No. 67-4. Sacramento, CA: The Resources Agency of Calif. Dept. of Fish and Game; 27 p.

This study evaluated the effects of logging on the stream and its

population of silver (Coho) salmon and steelhead trout. Changes in anadromous fish production were measured through counts of upstream and downstream migrants. Existing habitat in the stream was surveyed as well. Measurement of anadromous fish production was difficult owing to technical problems.

Key Terms: fisheries, stream ecology, logging

Keppeler, Elizabeth T. 1986. **The effects of selective logging on low flows and water yield in a coastal stream in northern California.**

Arcata, CA: Humboldt State University; 137 p. M.S. thesis.

Using a low flow season defined as a function of antecedent precipitation, streamflow data for a 21-year period were analyzed to determine the effects of selective tractor on the volume, timing, and duration of low flows, and annual water yield. Significant increases in streamflow were detected for both the annual period and the low flow season. Logging factors were found to be the most influential variables in describing flow differences between the control and treated watersheds. The enhancement of annual yield was well correlated to the percent of the watershed area converted to roads, landings, and skid trails.

Key Terms: streamflow, logging, roads

Keppeler, Elizabeth T. 1998. **The summer flow and water yield response to timber harvest.**

In: Ziemer, Robert R., technical coordinator. Proceedings of the conference on coastal watersheds: the Caspar Creek story, 1998 May 6; Ukiah, CA. Gen. Tech. Rep. PSW GTR-168. Albany, CA: Pacific Southwest Research Station, Forest Service, U.S. Department of Agriculture; 35-43.

Selection/tractor logging of the South Fork increased annual yield by a maximum of 2053 m³ha⁻¹ during the seventh water year after harvest began. Increased yields were observed beginning the second post-harvest year and averaged 15 percent or 932 m³ha⁻¹. Following clearcut logging 50 percent of the North Fork watershed, annual yield increased by as much as 1032 m³ha⁻¹ eight years post-logging and averaged 15 percent or 608 m³ha⁻¹ beginning in the second post-harvest year. Summer flow increases were evident on the South Fork for seven years after logging. Minimum summer flow discharge increases averaged 38 percent after the South Fork selection logging and 148 percent after the North Fork harvest and site preparation.

Key Terms: streamflow, soil moisture, summer flow, logging

Keppeler, Elizabeth T.; Brown, David. 1998. **Subsurface drainage processes and management impacts.**

In: Ziemer, Robert R., technical coordinator. Proceedings of the conference on coastal watersheds: the Caspar Creek story, 1998 May 6; Ukiah, CA. Gen. Tech. Rep. PSW GTR-168. Albany, CA: Pacific Southwest Research Station, Forest Service, U.S. Department of Agriculture; 25-34.

Storm-induced streamflow in forested upland watersheds is linked to rainfall by transient variably-saturated flow through several different flow paths. In the absence of exposed bedrock, shallow flow-restrictive layers, or compacted soil surfaces, virtually all of the infiltrated rainfall reaches the stream as subsurface flow. Subsurface runoff can occur within micropores (voids between soil grains), various types of macropores (structural voids between aggregates, plant and animal-induced biopores), and through fractures in weathered and consolidated bedrock. In addition to generating flow through the subsurface, transient rain events can also cause large increases in fluid pressures within a hillslope. If pore pressures exceed stability limits of soils and shallow geologic materials, landslides and debris flows may result.

Key Terms: soil moisture, pipeflow, saturated flow, landslide, macropore

Keppeler, E.T.; Cafferata, P.H. 1991. **Hillslope hydrology research at Caspar Creek.** Jackson Demonstration State Forest Newsletter, No. 41, April 1991. p. 4-8.

The latest technology is used for documenting variations in groundwater levels and soil moisture conditions from season to season and through storm events. Subsurface soil pipes are also monitored to observe changes in water movement.

Key Terms: hillslope hydrology, subsurface flow, logging, roads

Keppeler, Elizabeth T.; Ziemer, Robert R. 1990. **Logging effects on streamflow: water yields and summer low flows at Caspar Creek in northwestern California.** Water Resources Research 26(7): 1669-1679.

Streamflow data for a 21-year period were analyzed to determine the effects of selective tractor harvesting of second-growth Douglas-fir and redwood forest on the volume, timing, and duration of low flows and annual water yield in northwestern California. The flow response to logging was highly variable. Significant increases in streamflow were detected for both the annual period and the low-flow season.

Key Terms: streamflow, logging, roads

Keppeler, Elizabeth T.; Ziemer, Robert R.; Cafferata, P.H. 1994. **Changes in soil moisture and pore pressure after harvesting a forested hillslope in northern California.**

In: Marston, R.A.; Hasfurther, V.R., eds. Effects of human-induced changes on hydrologic systems; 1994 June 26-29; Jackson Hole, WY. Herndon, VA: American Water Resources Association; 205-214.

From 1987 to 1993, soil moisture conditions were measured along a 0.83-ha zero-order swale using pressure transducers connected to a digital data logger. In August 1989, the 100-year-old second-growth forest in the swale was felled, and logs were removed by cable yarding. Increases in peak piezometric levels and soil moisture were observed after logging. After logging, soil pipes continued to efficiently route surplus stormflows through an existing piping network. No slope failures were observed.

Key Terms: hillslope hydrology, soil moisture, pipeflow, storm runoff, logging

Kinerson, D.; Dietrich, William. 1990. **Bed surface response to sediment supply.** Berkeley, CA: Dept. of Geology and Geophysics, University of California; 420 p.

Land use changes in watersheds often lead to increased sediment supply to streams and to reduced habitat quality for the fish that live in these streams. There are three separable components to this land use problem: (1) the relationship between management practices and sediment yield, (2) the relationship between sediment supply and the stream channel morphology and dynamics, and (3) the relationship between sediment load and fish productivity. This study was designed in part to quantify these relationships in order to predict how changes in sediment supply will affect stream habitat.

Key Terms: sedimentation, stream ecology, channel morphology, bedload

Kopperdahl, F.R.; Burns, J.W.; Smith, G.E. 1971. **Water quality of some logged and unlogged California streams.**

Inland Fisheries Administrative Rept. No. 71-12. Sacramento, CA: Calif. Dept. of Fish and Game; 19 p.

Water quality was monitored in 1968 and 1969 in six coastal streams in northern California, four of which were subjected to logging and/or road building (among them South Fork Caspar Creek), while the others remained undisturbed (including North Fork Caspar Creek). The purposes of this study were to characterize the water quality of the streams, to determine whether the logging and road construction drastically altered water quality, and to collect data on water quality that could be tested for predicting stream carrying capacities for salmonids. Conditions were generally suitable for salmonids during and after the logging.

Key Terms: water quality, fisheries, logging, roads

Krammes, J.S.; Burns, D.M. 1973. **Road construction on Caspar Creek watersheds — a 10-year progress report.** Res. Paper PSW-93. Berkeley, CA: Pacific Southwest Forest and Range Experiment Station, USDA Forest Service; 10 p.

Measured suspended sediment yields increased by four fold during the first winter after right-of-way clearing, road building, and bridge construction; subsequent winter yields were not as excessive. Other impacts of the road implementation include increased water temperature, decreased young-of-the-year fish populations, and changes in composition of streambed particle size.

Key Terms: roads, logging, streamflow, sedimentation, fisheries

Lewis, J. 1991. **An improved bedload sampler.** In: Fan, S.; Kuo, Y.H., eds. Fifth Federal Interagency Sedimentation Conference Proceedings, 1991 March 18-21, Las Vegas, NV. Washington, DC: Federal Energy Regulatory Commission; 6-1 to 6-8.

Improvements upon the Birkbeck bedload sampler were implemented in the North Fork of Caspar Creek, a gravel-bedded stream. Bedload sediment falls through a slotted plate covering a 0.125-m³ steel box set within a formed concrete pit in the streambed. In two seasons of experimentation, the pillow and hydraulic and mechanical linkages of the Birkbeck-like sampler were replaced with an electronic load cell, resulting in more trouble-free operation, greater precision, and reduced background noise.

Key Terms: bedload, sediment, instrumentation, sampling

Lewis, Jack. 1996. **Turbidity-controlled suspended sediment sampling for runoff-event load estimation.** Water Resources Research 32(7): 2299-2310.

For estimating suspended sediment concentration (SSC) in rivers, turbidity is generally a much better predictor than water discharge. Measurements of SSC and turbidity were collected at 10-minute intervals from five storm events in a small, mountainous watershed (Caspar Creek) that exports predominantly fine sediment. Samples were selected from each storm's record, and event loads were estimated by predicting SSC from regressions on turbidity. Using simple linear regression, loads were estimated with root mean square errors consistently lower than those of sediment rating curve estimates based on the same samples.

Key Terms: suspended sediment, turbidity, storm runoff, sampling

Lewis, Jack. 1997. **Changes in storm peak flows after clearcut logging.** EOS, Transactions, American Geophysical Union 78(46): F314.

Streamflow in a Caspar Creek watershed was monitored at 13 locations before and after 50 percent of the watershed was logged, primarily by clearcutting. The logarithm of unit area peak flow was statistically modeled as a function of control watershed peak flow, proportion of watershed cut, antecedent wetness, and time since logging. The

logarithm of unit area peak flow was found to vary linearly with the proportion cut, the slope decreasing with increasing antecedent precipitation. Peak flow increases are attributed to loss of evapotranspiration and interception in the treated watersheds.

Key Terms: storm runoff, peak flow, logging

Lewis, Jack. 1998. **Evaluating the impacts of logging activities on erosion and sediment transport in the Caspar Creek watersheds.** In: Ziemer, Robert R., technical coordinator. Proceedings of the conference on coastal watersheds: the Caspar Creek story, 1998 May 6; Ukiah, CA. Gen. Tech. Rep. PSW GTR-168. Albany, CA: Pacific Southwest Research Station, Forest Service, U.S. Department of Agriculture; 55-69.

Suspended sediment has been sampled at both the North and South Fork weirs since 1963, and at 13 tributary locations in the North Fork since 1986. In the most conservative treatment of the data, suspended loads increased by 212 percent over the total predicted for a 6-year period commencing with the onset of logging in hydrologic year 1971. When the roles of the watersheds were reversed and the same analysis repeated to evaluate harvesting in the North Fork under California Forest Practice Rules in the 1990's, no significant increase was found at NFC in either annual suspended or bed load. Using a more sensitive analysis, for the 7-year period commencing with the onset of logging the North Fork, the sum of the suspended storm loads was 89 percent higher than that predicted for the undisturbed condition.

Key Terms: streamflow, suspended sediment, bedload, cumulative watershed effects, logging, roads

Lewis, Jack; Eads, Rand. 1996. **Turbidity-controlled suspended sediment sampling.** Watershed Management Council Newsletter 6(4): 1, 4-5.

In Caspar Creek, turbidity has been measured for estimating suspended sediment concentration (SSC). Results indicate that turbidity is generally a better predictor of SSC than water discharge. Turbidity also provides a more detailed picture of sediment transport than is normally available.

Key Terms: turbidity, suspended sediment, sampling, instrumentation

Lisle, T.E. 1979. **The Caspar Creek Experimental Watershed.** In: Guidebook for a field trip to observe natural and management-related erosion in Franciscan Terrane of northern California. Cordilleran Section of the Geological Society of America, 1979 April 9-11; San Jose, CA. Menlo Park, CA: Geological Society of America; XIV-1 to XIV-8.

This paper offers an overview of the Caspar Creek Experimental Watershed, including the project history, interpretations of the data, and future plans. Effects of logging and road construction on streamflow, erosion, and sedimentation are reported and discussed.

Key Terms: geology, streamflow, erosion, sedimentation, logging, roads

Lisle, T.E. 1989. **Sediment transport and resulting deposition in spawning gravels, north coastal California.** Water Resources Research 25(6): 1303-1319.

To relate sedimentation of spawning gravel beds to sediment transport, infiltration of fine sediment (<2 mm in diameter) into clean gravel beds, distribution of bed material size, scour-fill depths, and sediment transport during 10 storm flow events were measured in three streams of north coastal California. Great temporal and spatial variation in sedimentation in these streams suggests that individual storms of moderate size pose a threat to eggs in many but not all areas

selected by fish for spawning.

Key Terms: sediment transport, bedload, fisheries

Lisle, Thomas E.; Napolitano, Michael. 1998. **Effects of recent logging on the main channel of North Fork Caspar Creek.** In: Ziemer, Robert R., technical coordinator. Proceedings of the conference on coastal watersheds: the Caspar Creek story, 1998 May 6; Ukiah, CA. Gen. Tech. Rep. PSW-GTR-168. Albany, CA: Pacific Southwest Research Station, Forest Service, U.S. Department of Agriculture; 81-85.

The response of the mainstem channel of North Fork Caspar Creek to recent logging is examined by time trends in bed load yield, scour and fill at resurveyed cross sections, and the volume and fine-sediment content of pools. Changes in bed load yield were not detected despite a strong correlation between total scour and fill and annual effective discharge, perhaps because changes in stormflows were modest. The strongest responses are an increase in sediment storage and pool volume, particularly in the downstream portion of the channel along a buffer zone, where large woody debris (LWD) inputs are high.

Key Terms: sediment, bedload, large woody debris logging, pool volume

Maahs, Michael; Gilleard, Jim. 1994. **An evaluation of rehabilitation efforts based on carcass recovery and spawning activity.** Anadromous salmonid resources of Mendocino County coastal and inland rivers. Final Report, August 1994. Sacramento, CA: Calif. Dept. of Fish and Game; 60 p.

To evaluate the effectiveness of salmon-restoration efforts, spawning surveys were conducted in Mendocino County streams (including Caspar Creek) in 1991-1992 and in 1990-1991. Restoration activities were shown to be related to salmon production in several ways.

Key Terms: fisheries, stream ecology, stream restoration

Messer, Dean F.; Donaldson, Catherine L.; Parker, Michael S.; Knight, Allen W. 1994. **Effects of clear-cut logging practices on benthic communities of the North Fork Caspar Creek Watershed, Jackson State Demonstration Forest: Interim Report, Spring 1987 to Spring 1992.** Land, Air, and Water Resources Paper No. 100024. Davis, CA: University of California; 28 p.

The goal of this research has been to determine whether changes in physical processes related to clearcut logging are translated into changes in the structure and function of in-stream floral and faunal assemblages. This study obtained considerable data on benthic macroinvertebrate densities, relative abundance of common taxa and functional feeding groups, litter decomposition rates and benthic macroinvertebrates inhabiting leaf litter accumulations, and benthic algal standing crop and taxonomic structure at several sites along North Fork Caspar Creek. Although this study did uncover significant changes in several parameters, the specific reasons (drought or logging effects) for such changes remain unclear.

Key Terms: sedimentation, stream ecology, logging

Morken, Ingrid; Ziemer, Robert R. 1998. **Publications related to Caspar Creek.** In: Ziemer, Robert R., technical coordinator. Proceedings of the conference on coastal watersheds: the Caspar Creek story, 1998 May 6; Ukiah, CA. Gen. Tech. Rep. PSW-GTR-168. Albany, CA: Pacific Southwest Research Station, Forest Service, U.S. Department of Agriculture; 137-149.

Annotated bibliography of 107 papers produced during 36 years of research in the Caspar Creek Experimental Watershed.

Key Terms: paired watersheds, bibliography, monitoring, land management, resource issues

Nakamoto, Rodney. 1998. **Effects of timber harvest on aquatic vertebrates and habitat in the North Fork Caspar Creek.** In: Ziemer, Robert R., technical coordinator. Proceedings of the conference on coastal watersheds: the Caspar Creek story, 1998 May 6; Ukiah, CA. Gen. Tech. Rep. PSW-GTR-168. Albany, CA: Pacific Southwest Research Station, Forest Service, U.S. Department of Agriculture; 87-95.

An increase in large woody debris volume resulting from blowdown in the buffer zone following timber harvest increased the availability of pools and changed channel sediment storage characteristics. These changes suggest that yearling steelhead, Coho, and Pacific giant salamanders may benefit via increased living space and increased feeding efficiency.

Key Terms: aquatic vertebrates, steelhead, Coho, salamander, habitat, riparian

Napolitano, Michael Brent. 1996. **Sediment transport and storage in North Fork Caspar Creek, Mendocino County, California: water years 1980-1988.** Arcata, CA: Humboldt State University; 148 p. M.S. thesis.

A sediment budget for mainstem North Fork Caspar Creek was developed for water years 1980-1988 to evaluate controls on sediment storage changes. Sediment budget findings, Caspar Creek logging history, and research on large woody debris (LWD) were reviewed together to evaluate persistence of historical logging impacts. Comparison of LWD loading on North Fork Caspar Creek to similar streams in old-growth redwood basins suggests that this creek may not have recovered from 19th-century logging.

Key Terms: sedimentation, large woody debris, logging

Napolitano, Michael. 1998. **Persistence of historical logging impacts on channel form in mainstem North Fork Caspar Creek.** In: Ziemer, Robert R., technical coordinator. Proceedings of the conference on coastal watersheds: the Caspar Creek story, 1998 May 6; Ukiah, CA. Gen. Tech. Rep. PSW-GTR-168. Albany, CA: Pacific Southwest Research Station, Forest Service, U.S. Department of Agriculture; 97-101.

The old-growth redwood forest of Caspar Creek was clearcut between 1864 and 1904. Transportation of logs was by splash dam in the headwaters. Water stored behind the dam was released during large storms to sustain log drives. Before log drives could be conducted, all obstructions, including large woody debris (LWD) jams were removed from the channel. Comparison of present-day LWD loading on North Fork Caspar Creek (24 kg m²) to physically similar streams in old-growth redwood basins (49 to 268 kg m²) suggests that LWD loading and stability were greatly diminished by historical logging activities and change to second-growth cover.

Key Terms: historic logging, large woody debris, stream channel, redwood

Napolitano, Michael; Jackson, Francis; Cafferata, Peter. 1989. **A history of logging in the Caspar Creek basin.** Jackson Demonstration State Forest Newsletter, No. 33, April 1989. p. 4-7.

This article traces the history of logging in the Caspar Creek basin since the time of its first European settler, Siegrid Caspar, who was a trapper near the mouth of Caspar Creek before 1860. In 1860 the Caspar Lumber Company purchased 5,000 acres of forested terrain in the Caspar Creek basin. By 1890, logging had been completed over

most of the watershed with the help of crib dams, skid (or corduroy) roads, and steam donkeys. The tramway, crib dam, corduroy roads, and other historic artifacts of early logging days are easily observed in the North Fork basin today.

Key Terms: history, logging

O'Connor, Matthew D.; Ziemer, Robert R. 1989. **Coarse woody debris ecology in a second-growth *Sequoia sempervirens* forest stream.** In: Abell, Dana L., technical coordinator. Proceedings of the California Riparian Systems Conference: protection, management, and restoration for the 1990s; 1988 September 22-24; Davis, CA. Gen. Tech. Rep. PSW-110. Berkeley, CA: Pacific Southwest Forest and Range Experiment Station, Forest Service, U.S. Department of Agriculture; 165-171.

Coarse woody debris (CWD) volume, species, and input mechanisms were inventoried in North Fork Caspar Creek to assess rates of accumulation and dominant sources of CWD in a 100-year-old second-growth redwood forest. CWD accumulation in the active stream channel and in pools was studied to identify linkages between the forest and fish habitat.

Key Terms: coarse woody debris, channel morphology, stream ecology

Parker, Michael. 1991. **North Fork Caspar Creek stream biology study.** Jackson Demonstration State Forest Newsletter, No. 43, October 1991. p. 1-3.

Since spring 1987, a group of aquatic ecologists have been studying the effects of timber harvesting on stream biota in North Fork Caspar Creek to determine how current logging practices within a relatively undisturbed second-growth redwood forest influence the distribution and abundance of algae and invertebrates. Important invertebrates in North Fork Caspar Creek include mayflies, true flies, caddisflies, and stoneflies. Preliminary results indicate that small, relatively fast-growing mayflies and midges are more abundant after logging, probably owing to increases in algae abundance.

Key Terms: stream ecology, logging

Pearce, Richard B. 1993. **Caspar Creek: discovering how watersheds respond to logging.** Berkeley, CA: Pacific Southwest Research Station, USDA Forest Service; 6 p. (Revised from August 1987 issue of *Forestry Research West*).

This pamphlet provides a historical overview of the Caspar Creek watershed study, including results and future plans of the project. The findings have illuminated the extent and nature of the hydrologic impacts of logging operations "typical" for the time period.

Key Terms: streamflow, sedimentation, logging, roads, cumulative watershed effects, fisheries

Pert, Heather Anne. 1993. **Winter food habits of coastal juvenile steelhead and Coho salmon in Pudding Creek, northern California.** Berkeley, CA: University of California; 65 p. M.S. thesis.

Diets of juvenile Coho salmon and steelhead and the composition and density of drift were examined from November 1990 to April 1991 in the coastal stream Pudding Creek located to the north of the Caspar Creek drainage. Using some Caspar Creek data, drift density, antecedent precipitation, and water temperature were correlated to steelhead stomach fullness, whereas stomach fullness of Coho salmon was generally low and not well correlated with any of the variables measured. Winter floods may be important for food supply and sustaining salmonid growth and condition at these sites.

Key Terms: fisheries, storm runoff, stream ecology

Reid, Leslie M. 1998. **Cumulative watershed effects: Caspar Creek and beyond.** In: Ziemer, Robert R., technical coordinator. Proceedings of the conference on coastal watersheds: the Caspar Creek story, 1998 May 6; Ukiah, CA. Gen. Tech. Rep. PSW-GTR-168. Albany, CA: Pacific Southwest Research Station, U.S. Department of Agriculture; 117-127.

Cumulative effects are the combined effects of multiple activities, and watershed effects are those which involve processes of water transport. Past approaches to evaluating and managing cumulative watershed effects included the use of mechanistic predictive models, indices of land-use intensity, and open-ended analysis. None has yet proved successful for averting cumulative impacts. Approaches being discussed now include requirements for "zero net increase" of sediment, linkage of planned activities to mitigation of existing problems, use of more protective best management practices, and adoption of thresholds either for land-use intensity or for impact level. Future impact analysis methods probably will be based on strategies for watershed analysis.

Key Terms: cumulative effects, erosion, sediment, watershed, predictive models

Reid, Leslie M.; Hilton, Sue. 1998. **Buffering the buffer.** In: Ziemer, Robert R., technical coordinator. Proceedings of the conference on coastal watersheds: the Caspar Creek story, 1998 May 6; Ukiah, CA. Gen. Tech. Rep. PSW-GTR-168. Albany, CA: Pacific Southwest Research Station, Forest Service, U.S. Department of Agriculture; 71-80.

Riparian buffer strips help to sustain aquatic ecosystems and to protect downstream resources and values in forested areas, but controversy persists over how wide a buffer strip is necessary. Although most tree-fall-related sediment and woody debris inputs to Caspar Creek are generated by tree fall within a tree's height of the channel, trees falling from upslope of the contributing tree trigger about 30% of those tree falls.

Key Terms: riparian, buffer, woody debris, cumulative watershed effects, logging

Rice, R.M. 1987. **Cumulative impacts: current research and current opinions at PSW.** In: Proc. Impact '87, Annual Convention of California Licensed Foresters Association; 1987 March 6-7, 1987; Pioneer, CA; 1-12.

In 1985, scientists at the USDA Forest Service, Pacific Southwest Forest and Range Experiment Station (PSW) began collecting data in the Caspar Creek watershed for a study specifically designed to address cumulative watershed effects (CWEs).

Key Terms: cumulative watershed effects, sedimentation, logging, roads

Rice, R.M. 1991. **Cumulative watershed effects: can they be measured? What have we learned from the Caspar Creek studies in northern California?** In: The 1990s—challenging our profession and professionalism. Summaries of the proceedings of the 1990 western forestry conference, 1990 December 2-5; Coeur d'Alene, ID. Portland, OR: Western Forestry and Conservation Association; 92.

Cumulative Watershed Effects (CWEs) may be additive or synergistic. Additive CWEs are the sediment accumulation downstream caused by various activities (such as road construction). Synergistic effects are aggregates of additive CWEs. Even though Best Management Practices (BMP) are applied, synergistic CWEs may result in an unacceptable amount of suspended sediment in a stream and trigger additional impacts. Current research at Caspar Creek is aimed at estimating the magnitude of synergistic CWEs.

Key Terms: cumulative watershed effects, sedimentation, logging, roads

Rice, R.M. 1996. **Sediment delivery in the North Fork of Caspar Creek.** Unpubl. Final Rept. prepared for the Calif. Dept. of Forestry and Fire Protection, Agreement No. 8CA94077. 11 p.

Sediment delivery was estimated for 13 tributary watersheds and the North Fork of Caspar Creek. The median ratio of sediment to erosion was 6.3 percent. Data analyses suggest that more research is needed for estimating sheet erosion and stream channels as sediment sources. Compared to an earlier study in the South Fork of Caspar Creek, logging of the North Fork resulted in erosion that was about half as large and a sediment delivery ratio that was also about half of the 1979 estimate.

Key Terms: sedimentation, erosion, logging, roads

Rice, Raymond M. 1998. **Where do we go from here?** In: Ziemer, Robert R., technical coordinator. Proceedings of the conference on coastal watersheds: the Caspar Creek story, 1998 May 6; Ukiah, CA. Gen. Tech. Rep. PSW-GTR-168. Albany, CA: Pacific Southwest Research Station, Forest Service, U.S. Department of Agriculture; 135-136.

Suggests that future research in the North and South forks of Caspar Creek is to make of them a continuing study of the two main opposing silvicultural systems: even- and uneven-aged management. The South Fork has had one partial cut more than 25 years ago and is ready for another. The North Fork already has no adjacency problems; therefore, additional clearcuts could be made at any time. Hopefully, these analyses would include biological concerns as well as hydrologic effects.

Key Terms: paired watersheds, future study, monitoring, land management, resource issues

Rice, Raymond M. 1998. **Why Caspar Creek—then and now?** In: Ziemer, Robert R., technical coordinator. Proceedings of the conference on coastal watersheds: the Caspar Creek story, 1998 May 6; Ukiah, CA. Gen. Tech. Rep. PSW-GTR-168. Albany, CA: Pacific Southwest Research Station, Forest Service, U.S. Department of Agriculture; 11-13.

The results of every watershed experiment are a unique combination of the site, the weather, the questions asked, the quality of the data produced, and the quality of the analysis made of those data. These results narrow the scope of the environmental debate, but they will not alter the value systems of the debaters. By availing themselves of the available scientific information both sides can make their cases more persuasive to the courts, to the regulators, and *perhaps* to the public.

Key Terms: paired watersheds, research

Rice, R.M.; Tilley, F.B.; Datzman, P.A. 1979. **A watershed's response to logging and roads: South Fork of Caspar Creek, California, 1967-1976.** Res. Paper PSW-146. Berkeley, CA: Pacific Southwest Forest and Range Experiment Station, Forest Service, U.S. Department of Agriculture; 12 p.

A paired-watershed study in the North and South Forks of Caspar Creek demonstrates the effects of logging and road building on streamflow and sedimentation. On-site erosion, annual suspended sediment loads, and debris basin accumulations were estimated in order to evaluate the effects of road construction and the timber harvest. The South Fork watershed produced a threefold increase over that which would have been expected had the watershed remained undisturbed. Analysis of the sediment/stream power relationship of

Caspar Creek strongly suggests that the increase in sedimentation is due to the additional availability of logging and road-related sediment for transport.

Key Terms: roads, logging, erosion, sedimentation

Rodriguez, Albert; Jones, Weldon. 1993. **Investigations of salmon and steelhead trout: downstream migrations in Caspar Creek and Little River, Mendocino County, March-July, 1993.** Unpublished Rept. Calif. Dept. of Fish and Game, Sacramento, CA, 14 p.

Two coastal streams were compared in order to observe the different trend patterns of juvenile out-migrations for Coho salmon and steelhead trout. The size, timing, growth rate, and age classifications of salmonids were determined. Analysis of the 1993 trapping season indicates, at Little River, a decrease of steelhead trout yearlings but an increase in Coho yearlings. At Caspar Creek, Coho and trout yearlings were similar in magnitude and simultaneously tapered in late May.

Key Terms: fisheries, stream ecology

Sendek, Karen Hardison. 1985. **Effects of timber harvesting on the lag time of Caspar Creek watershed.** Arcata, CA: Humboldt State University; 46 p. M.S. thesis.

Hydrograph lag time was analyzed to determine changes after road construction and after selective, tractor-yarded logging in the Caspar Creek watershed. Six hydrologic variables were examined as predictors of the effect of logging on lag time. Proportion of area logged and the ratio of proportion of area logged divided by the storm sequence number were the best predictors. Other variables examined were North Fork peak flow, storm sequence number, storm size, and antecedent precipitation.

Key Terms: storm runoff, peak flow, logging, roads

Spittler, T.E. 1995. **Pilot monitoring program: geologic input for the hillslope component (includes a discussion of Caspar Creek geology and geomorphology).** Unpublished report prepared for the Calif. Dept. of Forestry and Fire Protection, Contract No. 8CA38400, Sacramento, CA. 18 p.

The development of hillslope monitoring techniques needed to evaluate the effectiveness of the Forest Practice Rules in protecting water quality is explained. The major component of Division of Mines and Geology (DMG) work involved defining the physical characteristics of the pilot watersheds, among them the North and South Forks of Caspar Creek above their weir dams. DMG also participated in the Monitoring Study Group to aid in developing analysis techniques for evaluating hillslope processes as well as procedures for selecting and evaluating monitoring locations for a possible long-term monitoring program.

Key Terms: hillslope processes, geology, stream ecology, logging

Spittler, T.E.; McKittrick, M.A.. 1995. **Geologic and geomorphic features related to landsliding, North and South Forks of Caspar Creek, Mendocino County, California.** Open File Rept. OFR 95-08, scale 1:12,000. Available from: Calif. Dept. of Conservation, Division of Mines and Geology, 801 K Street, MS 14-34, Sacramento, CA 95814-3532.

This set of two maps provides information about geology and geomorphic features of the watersheds of North and South Fork, Caspar Creek. The mapping for these areas was done at a scale of 1:12,000.

Key Terms: geology, geomorphic process, landslides, mapping

Surfleet, Christopher G.; Ziemer, Robert R. 1996. **Effects of forest harvesting on large organic debris in coastal streams.** In: LeBlanc, John, ed. Conference on coast redwood forest ecology and management; 1996 June 18-20; Arcata, CA. Berkeley, CA: University of California; 134-136.

Large organic debris (LOD) was inventoried in two coastal streams (the North and South Forks of Caspar Creek) to assess the impacts of forest harvesting on LOD recruitment in 90-year-old second-growth redwood and fir stands. LOD levels increased after harvest because residual trees were left adjacent to the stream or in streamside buffer strips. Windthrow of fir provided the largest input of LOD in these stands owing to the stand age and structure of the residual trees adjacent to the stream.

Key Terms: large woody debris, logging, buffer strips, channel morphology

Thomas, R.B. 1985. **"Artificial intelligence" at streamgaging stations.** EOS, Transactions, American Geophysical Union 66(46): 912.

Stream measurement involves technical/logistical problems of collecting and transferring data and questions of time-related sampling. Field microprocessors using sampling algorithms and real-time sensing of stream variables can substantially improve the quality of stream data collection.

Key Terms: streamflow, instrumentation, sampling

Thomas, Robert B. 1985. **Estimating total suspended sediment yield with probability sampling.** Water Resources Research 21(9): 1381-1388.

The "Selection At List Time" (SALT) scheme controls sampling of concentration for estimating total suspended sediment yield. The probability of taking a sample is proportional to its estimated contribution to total suspended sediment discharge. When applied to real data with known yield, the SALT method underestimated total suspended sediment yield by less than 1 percent, whereas the flow duration sediment rating curve method underestimated total suspended sediment yield by 51 percent.

Key Terms: suspended sediment, instrumentation, sampling

Thomas, R.B. 1985. **Measuring suspended sediment in small mountain streams.** Gen. Tech. Rep. PSW-83. Berkeley, CA: Pacific Southwest Forest and Range Experiment Station, Forest Service, U.S. Department of Agriculture; 9 p.

This report describes the problems in measuring suspended sediment in small mountain streams. The factors that govern the quality of data collected in a monitoring program are discussed.

Key Terms: suspended sediment, instrumentation, sampling

Thomas, R.B. 1988. **Measuring sediment yields of storms using PSALT.** In: Bordas, M.P.; Walling, D.E., eds. Sediment budgets, proceedings of the Porto Alegre Symposium; 1988 December 11-15; Brazil. International Association of Hydrological Sciences Publication No. 174. Wallingford, UK: IAHS; 101-109.

To sample and estimate sediment yields in Caspar Creek, PSALT (Piecewise Selection At List Time) — a probability-based method for sampling that enhances data collection during high flows — has been used. Because PSALT data are independent they can be combined to give unbiased estimates of suspended sediment yield and its variance during storms. Problems of applying the method to a large number of basins are discussed along with their solutions.

Key Terms: suspended sediment, sampling, storm runoff

Thomas, R.B. 1989. **Piecewise SALT sampling for estimating suspended sediment yields.** Gen. Tech. Rep. PSW-83. Berkeley, CA: Pacific Southwest Forest and Range Experiment Station, Forest Service, U.S. Department of Agriculture; 11 p.

SALT (Selection At List Time) is a method for collecting data on suspended sediment concentration and estimating total suspended sediment yield. The SALT estimates can consist of composites or portions of several SALT-monitored periods, known as "piecewise SALT sampling." This paper describes how to collect data and estimate sediment yield and its variance by piecewise SALT sampling, and discusses another method for setting sample size which is particularly appropriate for piecewise SALT sampling.

Key Terms: suspended sediment, sampling

Thomas, R.B. 1990. **Problems in determining the return of a watershed to pretreatment conditions: techniques applied to a study at Caspar Creek, California.** Water Resources Research 26(9): 2079-2087.

Using a previously treated basin as a control in subsequent paired-watershed studies requires the control to be stable. Recovering from logging and road building in the early 1970's, the South Fork of Caspar Creek was assessed for basin stability. The results of studying three storm-based discharge characteristics (peak discharge, quick flow, and total storm flow), daily flows, and concentration of suspended sediment indicate that the South Fork has returned to near pretreatment conditions.

Key Terms: storm runoff, suspended sediment, sampling

Thomas, Robert B.; Lewis, Jack. 1993. **A comparison of selection at list time and time-stratified sampling for estimating suspended sediment loads.** Water Resources Research 29(4): 1247-1256.

Time-stratified sampling of sediment for estimating suspended load is introduced and compared to selection at list time (SALT) sampling. The two methods are compared using five storm populations of suspended sediment flux derived from turbidity data. Both methods provide unbiased estimates of load and variance but vary in efficiency according to storm size and duration.

Key Terms: suspended sediment, sampling

Thomas, Robert B.; Lewis, Jack. 1993. **A new model for bedload sampler calibration to replace the probability-matching method.** Water Resources Research 29(3): 583-597.

In 1977, extensive data were collected to calibrate six Helley-Smith bedload samplers with four sediment particle sizes in a flume at the St. Anthony Falls Hydraulic Laboratory at the University of Minnesota. A new calibration model was developed that regresses transformed individual sampler measurements on daily means of transformed trap data and incorporates within-day variation in trap rates to explain part of the sampler variation. Results of this study can be used to design a more rigorous calibration experiment.

Key Terms: bedload, sampling, modeling, sedimentation

Thomas, R.B.; Lewis, Jack. 1995. **An evaluation of flow-stratified sampling for estimating suspended sediment loads.** Journal of Hydrology 170: 27-45.

Flow-stratified sampling is a new method for sampling water quality constituents such as suspended sediment to estimate loads. It is a statistical method requiring random sampling and yielding unbiased estimates of load and variance. Flow-stratified sampling is described

and its variance compared with those of selection-at-list-time (SALT) and time-stratified sampling.

Key Terms: sampling, suspended sediment, storm runoff

Tilley, F.B.; Rice, R.M. 1977. **Caspar Creek watershed study—a current status report.** State Forest Notes No. 66. Sacramento, CA: State of Calif., Department of Forestry; 15 p.

The primary objectives of the project are to measure the sediment produced by a north coastal watershed in an undisturbed condition and to measure the degree to which water quality, flood peaks, suspended sediment, and bedload are affected by road construction and logging when practices are designed to minimize excessive runoff and erosion. The most apparent effects of logging the South Fork were the increased amounts of suspended sediment and the greater responsiveness to precipitation.

Key Terms: peak flow, suspended sediment, bedload, roads, logging

Walton, K. 1988. **Downstream migrant trapping on Caspar Creek and Little River, March-June 1988.** Calif. Dept. of Fish and Game Unpublished Rept. Sacramento, CA. 8 p.

This study was conducted to observe the different trend patterns of juvenile out migrations for Coho salmon and steelhead-trout. The size, timing, growth rate and age classifications of salmonids for 1988 are reported.

Key Terms: fisheries, stream ecology

Wosika, Edward Pearson. 1981. **Hydrologic properties of one major and two minor soil series of the Coast Ranges of northern California.** Arcata, CA: Humboldt State University; 150 p. M.S. thesis.

The following properties of the Hugo, Mendocino, and Caspar soil series were analyzed at various depths: bulk density, porosity, particle density, saturated and unsaturated hydraulic conductivity, particle-size distribution, pore-size distribution, and water retention characteristics. The main factor producing differences between these three series and within the Hugo series is the degree of colluvial mixing, which is closely related to slope position. Also, the unsaturated hydraulic conductivity of the three series are sufficiently high at all soil depths to preclude the large-scale development of saturated subsurface flow.

Key Terms: soils, geology, subsurface flow

Wright, Kenneth A. 1985. **Changes in storm hydrographs after roadbuilding and selective logging on a coastal watershed in northern California.** Arcata, CA: Humboldt State University; 55 p. M.S. thesis.

The effects of road building and selective tractor harvesting on storm peak flows and storm volumes were assessed for the Caspar Creek watershed. Only the very small storm peaks or volumes were increased after roadbuilding and logging. The increases in small storm peaks and volumes are not considered significant to the stream's stability or sediment regime.

Key Terms: peak flows, storm runoff, logging, roads

Wright, Kenneth A.; Sendek, Karen H.; Rice, Raymond M.; Thomas, Robert B. 1990. **Logging effects on streamflow: storm runoff at Caspar Creek in northwestern California.** Water Resources Research 26(7): 1657-1667.

The effects of road building and selective tractor harvesting on storm runoff were assessed at Caspar Creek. Findings suggest no significant increases in storm volumes and peaks of large storms by either roads

or logging. In a rain-dominated hydrologic environment, logging and forest road construction (as carried out in this study) are not likely to change the flow regime of a stream adversely.

Key Terms: peak flows, logging, storm runoff

Ziemer, Robert R. 1968. **Fifth progress report, 1967, cooperative watershed management research, flood and sediment reduction in the lower conifer zone of California.** Berkeley, CA: Pacific Southwest Forest and Range Experiment Station, Forest Service, U.S. Department of Agriculture; 9 p.

Describes work on the Caspar Creek study during 1967.

Key Terms: experimental watersheds

Ziemer, Robert R. 1981. **Stormflow response to roadbuilding and partial cutting in small streams of northern California.** Water Resources Research 17(4): 907-917.

To assess the influence of roadbuilding and logging on storm flow response, the North Fork and South Fork of Caspar Creek were studied from 1963 to 1975. Selection cutting and tractor yarding of 85-year-old second-growth redwood and Douglas-fir forest did not significantly affect large peak flows. The effect of logging on peak flow was best predicted by a variable that represented the percentage of the area logged divided by the sequential storm number within the year.

Key Terms: streamflow, roads, logging

Ziemer, R.R. 1990. **The Caspar Creek Watersheds—a case study.** In: Callahan, R.Z., ed. Case studies and catalog of watershed projects in western provinces and states. Report 22. Davis: University of California Wildland Resources Center; 17-19, 81.

A synopsis of the Caspar Creek Experimental Watersheds, from their inception in 1962 to their status in 1990. The history, problems, objectives, and planning of the study are discussed.

Key Terms: streamflow, suspended sediment, bedload, cumulative watershed effects, logging, roads

Ziemer, R.R. 1992. **Effect of logging on subsurface pipeflow and erosion: coastal northern California, USA.** In: Walling, D.E.; Davies, T.R.; Hasholt, B., eds. Erosion, debris flows and environment in mountain regions, Proceedings of the Chendu symposium; 1992 July 5-9; Chendu, China. International Association of Hydrological Sciences Publication No. 209. Wallingford, UK: IAHS; 187-197.

Three zero-order swales, each with a contributing drainage area of about 1 ha, were instrumented to measure pipeflows within the Caspar Creek Experimental Watershed. After two winters of data collection, the second-growth forest on two of the swales was clearcut logged while the third swale remained an uncut control. After logging, peak pipeflow and suspended sediment load increased.

Key Terms: subsurface flow, pipeflow, suspended sediment, logging

Ziemer, R. 1996. **Caspar Creek streamflow and sediment records: 1963-1995.** CD-ROM, 200 MB. 1996 July. Arcata, CA: Pacific Southwest Research Station, USDA Forest Service, and Fort Bragg, CA: California Department of Forestry and Fire Protection.

This CD-ROM contains data records for the North and South Forks of Caspar Creek from 1963-1995, including annual precipitation, streamflow and sediment records, daily and 10-minute streamflow records, and a compilation of all suspended sediment samples collected.

Key Terms: streamflow, suspended sediment, precipitation, temperature, logging

Ziemer, R. 1998. **Caspar Creek hydrologic and climatic data: 1963-1997**. CD-ROM, 545 MB. 1998 May. Arcata, CA: Pacific Southwest Research Station, USDA Forest Service, and Fort Bragg, CA: California Department of Forestry and Fire Protection.

Detailed data files on this expanded CD-ROM include streamflow (1963-1997), suspended sediment (1963-1997), rainfall (1963-1997), solar radiation (1988-1997), channel cross-sections (1987-1997), and air and water temperatures (1989-1997). In addition, detailed streamflow and sediment data are included for 13 tributary stations that were installed in the North Fork in August 1985.

Key Terms: streamflow, suspended sediment, precipitation, solar radiation, channel morphology

Ziemer, Robert R. 1998. **Flooding and stormflows**. In: Ziemer, Robert R., technical coordinator. Proceedings of the conference on coastal watersheds: the Caspar Creek story, 1998 May 6; Ukiah, CA. Gen. Tech. Rep. PSW-GTR-168. Albany, CA: Pacific Southwest Research Station, Forest Service, U.S. Department of Agriculture; 15-24.

The effects of road building and timber harvest on storm flow were evaluated by studying 174 storms from 1963 through 1975 that produced peak discharges in the untreated North Fork larger than $0.016 \text{ L s}^{-1}\text{ha}^{-1}$. These smallest storm peaks occur on average about 14 times each year. Flows this size and larger occupy about 10 percent of the time, are responsible for 83 percent of the annual water discharge, and transport 99 percent of the suspended sediment. In 1985, an additional 13 gaging stations were installed in the North Fork. From 1985 through 1996, 526 peakflow observations were made, representing 59 storms. There was a mean peakflow increase of 35 percent in entirely clearcut and 16 percent in partially clearcut watersheds for the class of flows greater than $4 \text{ L s}^{-1}\text{ha}^{-1}$.

Key Terms: paired watersheds, peak streamflow

Ziemer, Robert R. 1998. **Monitoring watersheds and streams**. In: Ziemer, Robert R., technical coordinator. Proceedings of the conference on coastal watersheds: the Caspar Creek story, 1998 May 6; Ukiah, CA. Gen. Tech. Rep. PSW-GTR-168. Albany, CA: Pacific Southwest Research Station, Forest Service, U.S. Department of Agriculture; 129-134.

Regulations increasingly require monitoring to detect changes caused by land management activities. Successful monitoring requires that objectives be clearly stated. Once objectives are clearly identified, it is important to map out all of the components and links that might affect the issues of concern. Each issue and each component that affects that issue has a set of spatial and temporal scales within which they operate. These scales are not consistent between and amongst one another. For many issues, unusual events are more important than average conditions. Regulations developed from the consequences of small "normal" storms will be inadequate in that the data will not include the critical geomorphic events that affect the physical and biological concerns.

Key Terms: paired watersheds, peak streamflow, monitoring, land management, resource issues

Ziemer, Robert R. 1998. **Preface**. In: Ziemer, Robert R., technical coordinator. Proceedings of the conference on coastal watersheds: the Caspar Creek story, 1998 May 6; Ukiah, CA. Gen. Tech. Rep. PSW-GTR-168. Albany, CA: Pacific Southwest Research Station, Forest Service, U.S. Department of Agriculture; iii-iv.

The Conference was held May 6, 1998 at the Mendocino Community College in Ukiah, California, and was attended by about 400 persons. On May 7, 75 individuals participated in a field trip through the North Fork of Caspar Creek. There is keen interest in the effect of forest practices on the hydrologic response of watersheds. Attendance at both the Conference and the field trip was limited by seating capacity and a large number of potential registrants were turned away because of lack of space.

Key Terms: paired watersheds, conference, coastal watersheds

Ziemer, Robert R., technical coordinator. 1998. **Proceedings of the conference on coastal watersheds: the Caspar Creek story**. 1998 May 6; Ukiah, CA. Gen. Tech. Rep. PSW-GTR-168. Albany, CA: Pacific Southwest Research Station, Forest Service, U.S. Department of Agriculture; 149 p.

Proceedings contain a preface, 15 papers, and a detailed annotated bibliography of papers produced during 36 years of research in the Caspar Creek Experimental Watershed.

Key Terms: paired watersheds, streamflow, sediment, nutrient, riparian, cumulative effects, soil moisture

Ziemer, R.R.; Albright, J.S. 1987. **Subsurface pipeflow dynamics of north-coastal California swale systems**. In: Beschta, R.; Blinn, T.; Grant, G.E.; Swanson, F.J.; Ice, G.G., eds. Erosion and sedimentation in the Pacific Rim, Proceedings of the Corvallis Symposium, 1987 August. International Association of Hydrological Sciences Publication No. 165. Wallingford, UK: IAHS; 71-80.

Pipeflow dynamics at Caspar Creek is discussed. During storms, pipeflow up to 8 L s^{-1} has been measured, whereas, within the same swales, no surface channel flow occurred. Pipeflow discharge has been correlated with antecedent precipitation.

Key Terms: pipeflow, storm runoff, subsurface flow, hillslope hydrology

Ziemer, R.R.; Cafferata, P.H. 1992. **The Caspar Creek watersheds: a case study of cumulative effects in a small coastal basin in northern California**. In: Proceedings 1991 SAF National Convention; 1991 August 4-7; San Francisco, CA. San Francisco, CA: Society of American Foresters; 2 p.

This paper gives an overview of the Caspar Creek experimental watersheds from 1962 to 1992. In 1985 the study was modified to evaluate the cumulative watershed effects of logging the North Fork. Intensively measured were precipitation, soil moisture, groundwater, subsurface pipeflow, streamflow and suspended sediment discharge at 15 gauging stations, bedload movement, stream channel stability, large woody debris, and anadromous fish habitat.

Key Terms: cumulative watershed effects, streamflow, storm runoff, sedimentation, logging, roads

Ziemer, Robert R.; Kojan, Eugene; Thomas, Robert B. 1965. **Third progress report, 1965, cooperative watershed management in the lower conifer zone of California**. Berkeley, CA: Pacific Southwest Forest and Range Experiment Station, Forest Service, U.S. Department of Agriculture; 33 pp.

Describes instrumentation and presents data on streamflow, precipitation, and sedimentation collected between October 1, 1963 and September 30, 1965. Discusses the stream ecology study conducted by John DeWitt, Richard Ridenhour, and James Andrews of Humboldt State College.

Key Terms: experimental watersheds, stream ecology

Ziemer, Robert R.; Kojan, Eugene; Thomas, Robert B.; Muller, Robert A. 1966. **Fourth progress report, 1966, cooperative watershed management research, flood and sediment reduction in the lower conifer zone of California.** Berkeley, CA: Pacific Southwest Forest and Range Experiment Station, Forest Service, U.S. Department of Agriculture; 88 p.

Describes instrumentation and presents data on streamflow, precipitation, and sedimentation collected between October 1, 1963 and September 30, 1965. Discusses the stream ecology study conducted by John DeWitt, Richard Ridenhour, and James Andrews of Humboldt State College.

Key Terms: experimental watersheds, stream ecology

Ziemer, Robert R.; Lewis, Jack; Keppeler, Elizabeth T. 1996. **Hydrologic consequences of logging second-growth watersheds.** In: LeBlanc, John, ed. Conference on coast redwood forest ecology and management; 1996 June 18-20; Arcata, CA. Berkeley, CA: University of California; 131-133.

Streamflow, suspended sediment, and bedload have been gauged continuously since 1962 in the 473-ha North Fork and the 424-ha South Fork of Caspar Creek. During the course of the study, logging

roads were built and approximately 65 percent of the timber volume was selectively cut in the South Fork and clearcut in the North Fork. Large peak flows did not change significantly in either watershed. To date, the effect on sediment loads of logging in the North Fork has been much smaller than that following logging in the South Fork.

Key Terms: streamflow, peak flow, suspended sediment, bedload, logging

Ziemer, R.R.; Rice, R.M. 1990. **Tracking rainfall impulses through progressively larger drainage basins in steep forested terrain.** In: Lang, H.; Musy, A., eds. Hydrology in mountainous regions. I - Hydrological measurements; the water cycle, proceedings of two Lausanne symposia, 1990 August. International Association of Hydrological Sciences Publication No. 193. Wallingford, UK: IAHS; 413-420.

The precision of timing devices in modern electronic data loggers makes it possible to study the routing of water through small drainage basins having rapid responses to hydrologic impulses. By using such means as digital tipping bucket raingauges, naturally occurring soil pipes, streamflow gauging stations, and piezometers, stream discharge and routing can be measured. Peak lag time increased significantly downstream, and peak unit area discharge decreased downstream.

Key Terms: precipitation, storm runoff, subsurface flow

The Forest Service, U.S. Department of Agriculture, is responsible for Federal leadership in forestry.

It carries out this role through four main activities:

- Protection and management of resources on 191 million acres of National Forest System lands
- Cooperation with State and local governments, forest industries, and private landowners to help protect and manage non-Federal forest and associated range and watershed lands
- Participation with other agencies in human resource and community assistance programs to improve living conditions in rural areas
- Research on all aspects of forestry, rangeland management, and forest resources utilization.

The Pacific Southwest Research Station

- Represents the research branch of the Forest Service in California, Hawaii, American Samoa, and the western Pacific.



The United States Department of Agriculture (USDA) prohibits discrimination in all its programs and activities on the basis of race, color, national origin, gender, religion, age, disability, political beliefs, sexual orientation, and marital or familial status. (Not all prohibited bases apply to all programs.) Persons with disabilities who require alternative means for communication of program information (Braille, large print, audiotape, etc.) should contact USDA's TARGET Center at 202-720-2600 (voice and TDD).

To file a complaint of discrimination, write

USDA, Director
Office of Civil Rights
Room 326-W, Whitten Building
14th and Independence Avenue, SW
Washington, DC 20250-9410

or call

(202) 720-5964 (voice or TDD).

USDA is an equal opportunity provider and employer.



United States
Department
of Agriculture

Forest Service

Pacific Southwest
Research Station

General Technical Report
PSW-GTR-168



Proceedings of the Conference on Coastal Watersheds: The Caspar Creek Story

May 6, 1998 Ukiah, California





United States
Department
of Agriculture

Forest Service

Pacific Southwest
Research Station

General Technical Report
PSW-GTR-168



Proceedings of the Conference on Coastal Watersheds: The Caspar Creek Story

May 6, 1998 Ukiah, California

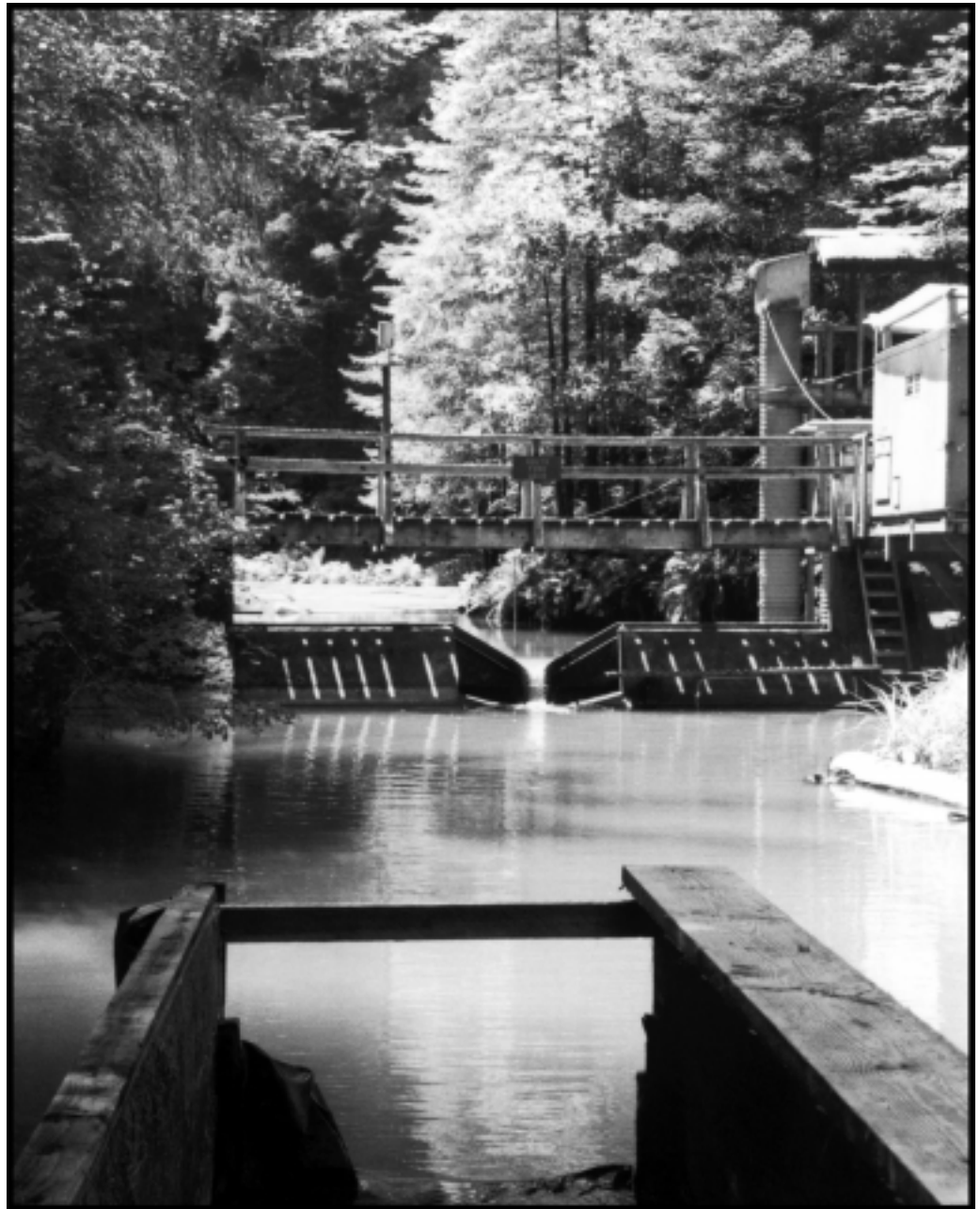

Publisher:

Albany, California
Mailing address:
PO Box 245, Berkeley CA
94701-0245

(510) 559-6300

[http://www.psw.fs.fed.us/
techpub.html](http://www.psw.fs.fed.us/techpub.html)

June 1998

Pacific Southwest Research Station

Forest Service
U.S. Department of Agriculture

Abstract

Ziemer, Robert R., technical coordinator. 1998. **Proceedings of the conference on coastal watersheds: the Caspar Creek Story; 6 May 1998; Ukiah, CA.** Gen. Tech. Rep. PSW-GTR-168. Albany, CA: Pacific Southwest Research Station, Forest Service, U.S. Department of Agriculture; 149 p.

These proceedings report on 36 years of research at the Caspar Creek Experimental Watershed, Jackson Demonstration State Forest in northwestern California. The 16 papers include discussions of streamflow, sediment production and routing, stream channel condition, soil moisture and subsurface water, nutrient cycling, aquatic and riparian habitat, streamside buffers, cumulative effects, monitoring. A detailed annotated bibliography of 107 papers from Caspar Creek is included.

Retrieval Terms: cumulative effects, nutrient, paired-watersheds, riparian, sediment, soil moisture, streamflow

Technical Coordinator

Robert R. Ziemer is Project Leader and Chief Research Hydrologist at the Station's Redwood Sciences Laboratory, 1700 Bayview Drive, Arcata, CA 95521.

Acknowledgments

Since 1961, research at the Caspar Creek Experimental Watersheds, located on the Jackson Demonstration State Forest, has been a cooperative venture between the California Department of Forestry and Fire Protection and the USDA Forest Service's Pacific Southwest Research Station (Agreement 12-11-0215-19).

Front cover: A view of the South Fork Caspar Creek gaging station (SFC), looking upstream from the fish ladder toward the weir. Photo by Norm Henry, California Department of Forestry and Fire Protection.

Back cover: A view of the tributary Dollard gaging station (DOL) in the North Fork of Caspar Creek, looking upstream at the Parshall flume. Photo by Norm Henry, California Department of Forestry and Fire Protection.

The Forest Service, U.S. Department of Agriculture, is responsible for Federal leadership in forestry.

It carries out this role through four main activities:

- Protection and management of resources on 191 million acres of National Forest System lands
- Cooperation with State and local governments, forest industries, and private landowners to help protect and manage non-Federal forest and associated range and watershed lands
- Participation with other agencies in human resource and community assistance programs to improve living conditions in rural areas
- Research on all aspects of forestry, rangeland management, and forest resources utilization.

The Pacific Southwest Research Station

- Represents the research branch of the Forest Service in California, Hawaii, American Samoa, and the western Pacific.



The United States Department of Agriculture (USDA) prohibits discrimination in all its programs and activities on the basis of race, color, national origin, gender, religion, age, disability, political beliefs, sexual orientation, and marital or familial status. (Not all prohibited bases apply to all programs.) Persons with disabilities who require alternative means for communication of program information (Braille, large print, audiotape, etc.) should contact USDA's TARGET Center at 202-720-2600 (voice and TDD).

To file a complaint of discrimination, write

USDA, Director
Office of Civil Rights
Room 326-W, Whitten Building
14th and Independence Avenue, SW
Washington, DC 20250-9410

or call

(202) 720-5964 (voice or TDD).

USDA is an equal opportunity provider and employer.



Federal Recycling Program
Printed on Recycled Paper

United States
Department
of Agriculture

Forest Service

Pacific Southwest
Research Station

General Technical Report
PSW-GTR-168



Proceedings of the Conference on Coastal Watersheds: The Caspar Creek Story

May 6, 1998 Ukiah, California
**Proceedings of the Conference on
Coastal Watersheds: The Caspar Creek Story**

May 6, 1998 Ukiah, California

